

Aspire Z5600/Z5610 Series Service Guide

Service guide files and updates are available on the ACER/CSD web; for more information, please refer to <http://csd.acer.com.tw>

PRINTED IN TAIWAN

Revision History

Please refer to the table below for the updates made on Aspire Z5600/Z5610 Series service guide.

Date	Chapter	Updates

Copyright

Copyright © 2009 by Acer Incorporated. All rights reserved. No part of this publication may be reproduced, transmitted, transcribed, stored in a retrieval system, or translated into any language or computer language, in any form or by any means, electronic, mechanical, magnetic, optical, chemical, manual or otherwise, without the prior written permission of Acer Incorporated.

Disclaimer

The information in this guide is subject to change without notice.

Acer Incorporated makes no representations or warranties, either expressed or implied, with respect to the contents hereof and specifically disclaims any warranties of merchantability or fitness for any particular purpose. Any Acer Incorporated software described in this manual is sold or licensed "as is". Should the programs prove defective following their purchase, the buyer (and not Acer Incorporated, its distributor, or its dealer) assumes the entire cost of all necessary servicing, repair, and any incidental or consequential damages resulting from any defect in the software.

Acer is a registered trademark of Acer Corporation.

Intel is a registered trademark of Intel Corporation.

Pentium and Pentium II/III are trademarks of Intel Corporation.

Other brand and product names are trademarks and/or registered trademarks of their respective holders.

Conventions

The following conventions are used in this manual:

SCREEN MESSAGES	Denotes actual messages that appear on screen.
NOTE	Gives bits and pieces of additional information related to the current topic.
WARNING	Alerts you to any damage that might result from doing or not doing specific actions.
CAUTION	Gives precautionary measures to avoid possible hardware or software problems.
IMPORTANT	Reminds you to do specific actions relevant to the accomplishment of procedures.

Preface

Before using this information and the product it supports, please read the following general information.

1. This Service Guide provides you with all technical information relating to the BASIC CONFIGURATION decided for Acer's "global" product offering. To better fit local market requirements and enhance product competitiveness, your regional office MAY have decided to extend the functionality of a machine (e.g. add-on card, modem, or extra memory capability). These LOCALIZED FEATURES will NOT be covered in this generic service guide. In such cases, please contact your regional offices or the responsible personnel/channel to provide you with further technical details.
2. Please note WHEN ORDERING FRU PARTS, that you should check the most up-to-date information available on your regional web or channel. If, for whatever reason, a part number change is made, it will not be noted in the printed Service Guide. For ACER-AUTHORIZED SERVICE PROVIDERS, your Acer office may have a DIFFERENT part number code to those given in the FRU list of this printed Service Guide. You MUST use the list provided by your regional Acer office to order FRU parts for repair and service of customer machines.

System Specifications	1
Features	1
System Block Diagram	3
Your Acer Computer tour	4
Front View	4
Right View	5
Left View	6
Rear View	7
Using the Keyboard	8
Windows Keys	9
Hardware Specifications and Configurations	10
System Utilities	17
BIOS Setup Utility	17
Navigating the BIOS Utility	17
Information	18
Main	19
Advanced	23
Security	26
PC Health	29
Power	30
Boot	31
Exit	32
Machine Disassembly and Replacement	33
Disassembly Requirements	33
General Information	33
Pre-disassembly Instructions	33
Disassembly Process	34
Disassembly Flowchart	34
Removing the RAM Cover	35
Removing the Hinge Cover	36
Removing the RAM	37
Removing the Rear Covers	38
Removing the Back Cover	39
Removing the Hinge	41
Removing the Back Frame	42
Removing the Power Supply	44
Removing the HDD Module	45
Removing the B-CAS Board	46
Removing the SSD Module	47
Removing the Control Board	48
Removing the Card Reader Board	49
Removing the Audio Board	50
Removing the ODD Button Board	51
Removing the ODD Module	52
Removing the Inverter Board	53
Removing the Home Button Board	55
Removing the Web Camera Board	56
Removing the TV Tuner Board	57
Removing the WLAN Board	58
Removing the CPU Fan	59
Removing the Thermal Module	60
Removing the CPU	61

Table of Contents

Removing the Mainboard Cables	62
Removing the Mainboard	63
Removing the LCD Assembly	64
Removing the LCD Bracket	68
Reassembly Procedure	69
Replacing the LCD Bracket	69
Replacing the LCD Assembly	70
Replacing the Mainboard	73
Replacing the Mainboard Cables	74
Replacing the CPU	75
Replacing the Thermal Module	76
Replacing the CPU Fan	77
Replacing the WLAN Board	78
Replacing the TV Tuner Board	79
Replacing the Web Camera Board	80
Replacing the Home Button Board	81
Replacing the Inverter Board	82
Replacing the ODD Module	84
Replacing the ODD Button Board	85
Replacing the Audio Board	86
Replacing the Card Reader Board	87
Replacing the Control Board	88
Replacing the SSD	89
Replacing the B-CAS Board	90
Replacing the HDD Module	92
Replacing the Power Supply	93
Replacing the Back Frame	94
Replacing the Hinge	96
Replacing the Back Cover	97
Replacing the Rear Covers	99
Replacing the RAM	100
Replacing the Hinge Cover	101
Replacing the RAM Cover	102
Troubleshooting	103
Common Problems	103
ODD Failure	104
Wireless Failure	107
Camera Failure	108
Speaker Failure	109
LCD Failure	111
General Troubleshooting Issues	113
Intermittent Problems	116
Undetermined Problems	116
Jumper and Connector Locations	117
Top View	117
Bottom View	118
Clearing Password Check and BIOS Recovery	119
Clearing Password Check	119
BIOS Recovery by Crisis Disk	120
FRU (Field Replaceable Unit) List	123
Aspire Z5600/Z5610 Series Exploded Diagrams	124
Main Assembly	124

Table of Contents

FRU List	126
Screw List	134
Model Definition and Configuration	136
Aspire Z5600/Z5610 Series	136
Test Compatible Components	187
Microsoft® Windows® 7 Environment Test	188
Online Support Information	197
Index	199

Table of Contents

System Specifications

Features

Below is a brief summary of the computer's many features:

Operating System

- Genuine Windows® 7 Home Premium (Touch Pack)*

Platform

- Intel Core™2 Quad Processor*
- Intel Core™2 Duo Processor*
- Intel Pentium Processor*
- Intel® Celeron® processor*
- Intel Eaglelake G45(B/S)+ICH10(B/S)*

Dimensions

- 570 (W) x 484.0 (H) x 84.6 (D) mm

System Memory

- Up to 8 GB of DDR3 1066/1333 MHz (dual-channel support on four DIMMs)*

Display

- 23" Full HD 1920 x 1080 pixel resolution, high brightness TFT LCD
- 16:9 aspect ratio
- 5 ms response time
- 16.7 million colors
- 1000:1 (ACM) contrast ratio
- Integrated Windows® 7 compliant multi-touch capable optical solution

TV Tuner

- Hybrid analog (NTSC/PAL/SECAM) and digital (DVB-T or ATSC format) TV-tuner card, supporting software MPEG-2 stream encoding*

Storage subsystem

- Hard Drive
 - SATA 3 Gb/s hard disk up to 1 TB*
 - SATA 3 Gb/s hard disk up to 1 TB with SSD NAND flash module up to 64 GB*
- Desktop Optical Disk Drive

-
- SuperMulti with LabelFlash™ technology DVD-ROM*

Communication

- Built-in 1 MP high-def webcam with 1280 x 800 resolution image capture
- Built-in microphone
- Gigabit Ethernet, Wake-on-LAN ready
- WLAN*
 - 802.11b/g/Draft-N
- WPAN*
 - Bluetooth® 2.1+EDR (Enhanced Data Rate)

Graphics

- Intel® GMA X4500HD (Intel® G45) (Aspire Z5600)
- ATI Radeon™ HD 4670 with 1 GB DDR3 Memory (Aspire Z5610)
- ATI Radeon™ HD 4570 with 512 MB DDR2 Memory (Aspire Z5610)

I/O interface

- Two USB 2.0 ports
- Multi-in-1 card reader
- High-definition headphone and microphone jacks
- Ambient light switch
- BCAS card Reader Slot (Japan only)
- Four USB 2.0 ports
- DC-in jack
- Ethernet (RJ-45) port
- Four audio ports
- eSATA port
- IR blaster port2 (bundle with TV tuner card)
- TV-tuner port2

Environment

- Temperature:
 - Operating: 5 °C to 35 °C
 - Non-operating: -20 °C to 65 °C
- Humidity (non-condensing):
 - Operating: 20% to 80%
 - Non-operating: 20% to 80%

NOTE: Items marked with * denote only selected models.

NOTE: The specifications listed above are for reference only. The exact configuration of your PC depends on the model purchased.

System Block Diagram

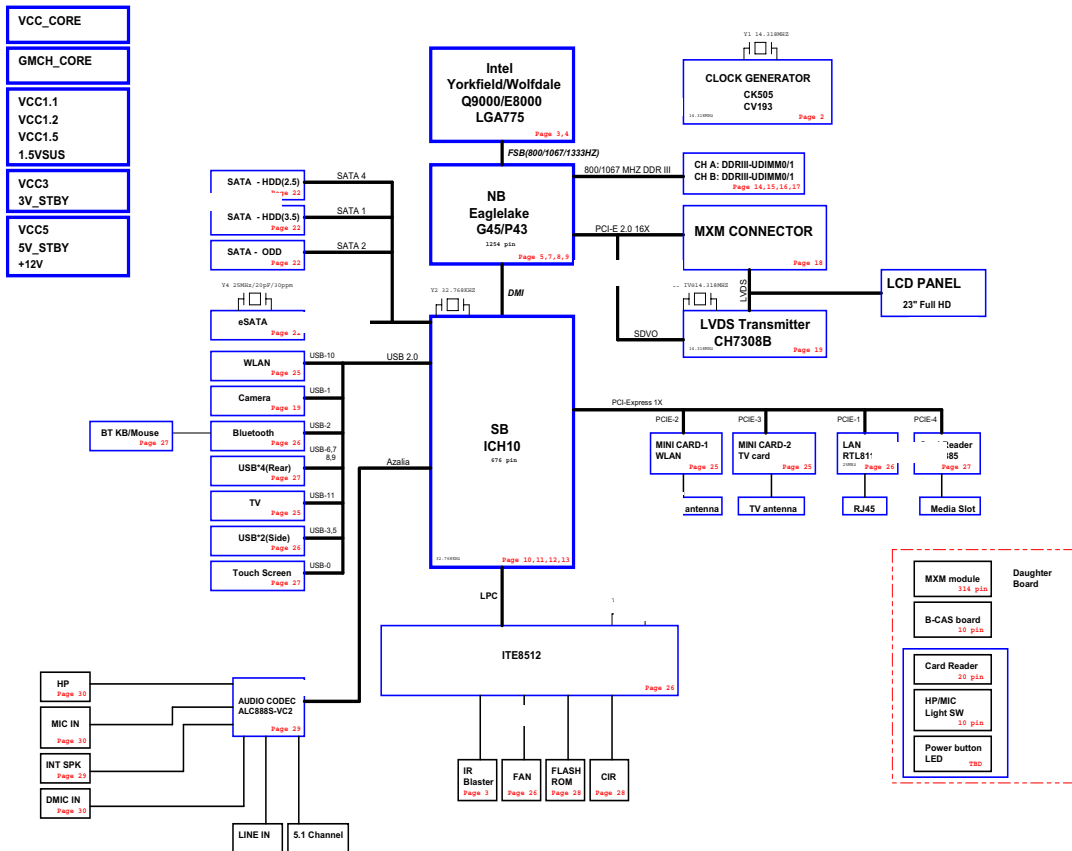

Your Acer Computer tour

After knowing your computer features, let us show you around your new computer.

IMPORTANT:Your computer's hardware options, port locations, and indicators may vary from this illustration.

Front View







No.	Component	Icon	Description
1	Microphone		Use to talk through when making Voice over Internet Protocol (VoIP) calls.
2	HD webcam		Use to let others see who they are communicating with when making VoIP calls.
3	Display screen		Also called Liquid-Crystal Display (LCD), displays computer output.
4	Acer TouchPortal		Access and control some of the handy features of your new computer.
5	Power Button		Press this button to turn the power on or off. You can also configure the power button to operate in Standby/Resume mode or Hibernate mode.

Right View

IMPORTANT:Your computer's hardware options, port locations, and indicators may vary from this illustration.



No.	Component	Icon	Description
1	Headphone jack (white plug)		Plug powered, analog front speakers, an external amplifier, or headphones into this jack.
2	Microphone jack (pink plug)		Plug a microphone into this jack.
3	Illumination Toggle Switch		<div style="border: 1px solid red; height: 20px; width: 100%;"></div>
4	Memory card reader		Insert a memory card from a digital camera, MP3 player, PDA, cellular telephone, or other device into the memory card reader.
5	Optical Disk Drive		Use this drive to listen to audio CDs, install games and programs, watch DVDs, and store large files onto recordable discs (depending on drive type). This drive may be a CD, recordable CD, DVD, or recordable DVD.

Left View

IMPORTANT:Your computer's hardware options, port locations, and indicators may vary from this illustration.





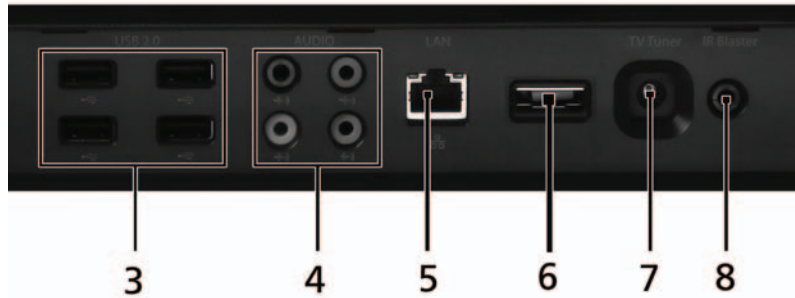

No.	Component	Icon	Description
1	B-CAS reader		Subscription service available for select models only.
2	USB 2.0 port		Plug USB (Universal Serial Bus) devices (such as a USB external drive, printer, scanner, camera, keyboard, or mouse) into this port.

Rear View

IMPORTANT:Your computer's hardware options, port locations, and indicators may vary from this illustration.





No.	Component	Icon	Description
1	Power connector		Plug the power cord into this connector.
2	Kensington™ lock slot		Secure your computer to an object by connecting a Kensington cable lock to this slot.
3	USB ports		Plug USB (Universal Serial Bus) devices (such as a USB printer, scanner, camera, keyboard, or mouse) into these ports.
4	Ethernet (network) jack		Plug an Ethernet network cable or a device (such as a DSL or cable modem for a broadband Internet connection) into this jack.
5	Line-out/Speaker-out jack		Plug an line output to an amplifier or entertainment system into this jack for sound output.
6	eSATA port		Plug external hard drives into this connector.
7	TV Tuner		Allows a TV Tuner to be connected to the system.
8	IR port		Allows data transfer between the desktop and a mobile device.

Using the Keyboard

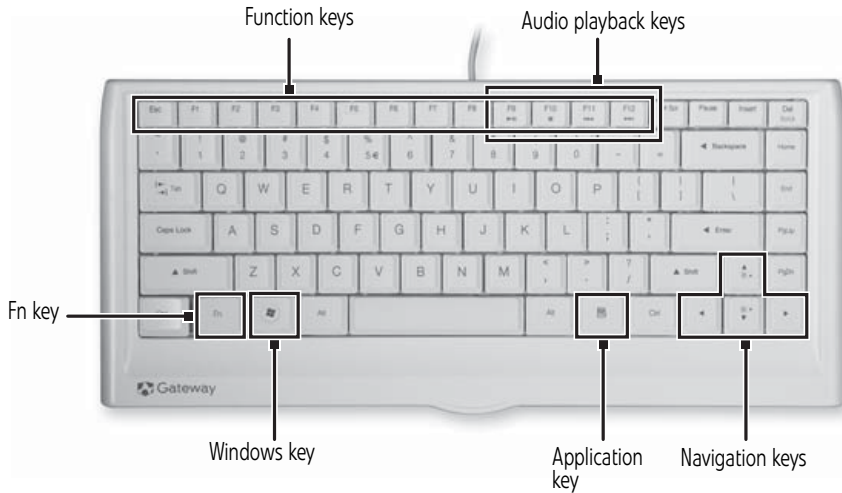

















The keyboard has several different types of keys and buttons as shown below.



Feature	Icon	Description
Function keys		Press these keys to start program actions. Each program uses different function keys for different purposes. See the program documentation to find out more about the function key actions.
Audio playback keys		Press these keys to play your audio files and to adjust the volume.
Windows key		Press this key to open the Windows Start menu. This key can also be used in combination with other keys to open utilities. See "Windows Keys" on page 9.
Fn key		Press this key in combination with keys that have alternate functions defined, such as the F9-F12 keys. Press <Fn> + <Δ> to increase the brightness of the display. Press <Fn> + <▽> to decrease the brightness of the display.
Application key		Press this key to access shortcut menus and help assistants in Windows.
Navigation keys		Press these keys to move the cursor and to copy, cut, and paste objects.

Windows Keys

The keyboard has two keys that perform Windows-specific functions.

Key	Description
 Windows key	<p>Pressed alone, this key has the same effect as clicking on the Windows Start button; it launches the Start menu. It can also be used with other keys to provide a variety of functions:</p> <ul style="list-style-type: none"><  >: Open or close the Start menu<  > + <D>: Display the desktop<  > + <E>: Open Windows Explore<  > + <F>: Search for a file or folder<  > + <G>: Cycle through Sidebar gadgets<  > + <L>: Lock your computer (if you are connected to a network domain), or switch users (if you're not connected to a network domain)<  > + <M>: Minimizes all windows<  > + <R>: Open the Run dialog box<  > + <T>: Cycle through programs on the taskbar<  > + <U>: Open Ease of Access Center<  > + <X>: Open Windows Mobility Center<  > + <BREAK>: Display the System Properties dialog box<  > + <SHIFT+M>: Restore minimized windows to the desktop<  > + <TAB>: Cycle through programs on the taskbar by using Windows Flip 3-D<  > + <SPACEBAR>: Bring all gadgets to the front and select Windows Sidebar<CTRL> + <  > + <F>: Search for computers (if you are on a network)<CTRL> + <  > + <TAB>: Use the arrow keys to cycle through programs on the taskbar by using Windows Flip 3-D <p>Note: Depending on your edition of Windows 7, some shortcuts may not function as described.</p>
 Application key	This key has the same effect as clicking the right mouse button; it opens the application's context menu.

Hardware Specifications and Configurations

Processor

Item	Specification
CPU type	<ul style="list-style-type: none"> • Intel Core™2 Quad Processor* • Intel Core™2 Duo Processor* • Intel Pentium Processor* • Intel® Celeron® processor*
Core Logic	<ul style="list-style-type: none"> • North Bridge (Eaglelake G45) • GTL+ interface (Front-side bus) <ul style="list-style-type: none"> • Support Intel Yorkfield/Wolfdale Processor • 800/1066/1333MHz transfer rate processor bus speed • Integrated DRAM controller <ul style="list-style-type: none"> • Dual-channel DDR3 SDRAM interface. • Unified Memory Architecture, with 128 MB to 256MB of the main memory configurable as display memory. • Asynchronous FSB and Memory Controller. • Supports Dual channel 800/1066 DDR3 SDRAM. • Max 8GB memory addressability, for faster system. • Serial ATA <ul style="list-style-type: none"> • Support maximum four SATA 3.0Gb/s ports.. • South Bridge (ICH10)PCI bus Interface <ul style="list-style-type: none"> • Supports PCI bus at 33MHz • PCI Rev.2.3 specification support. • Support for 64 bit addressing on PCI using DAC protocol.SMBus: SM Bus Rev.2.0 compliant. • Support Power management <ul style="list-style-type: none"> • ACPI Specification 3.0 compliant power management scheme. • ACPI-defined power states(C1, S1, S3, S4, S5 for Desktop) • ACPI-defined power states(C1~C4, S1, S3~S5 for Mobile) • ACPI Power Management Timer • SMI# generation • Low Pin Count(LPC) host interface • PCI Express Interface <ul style="list-style-type: none"> • Support PCI Express 1.1 • 6 PCI Express root ports • Support for full 2.5 Gb/s bandwidth in each direction per x1 lane
CPU Package	Flip-Chip Land Grid Array (FC-LGA8) technology
CPU Core Voltage	1.196 ±0.748

Processor Specifications

Processor #	CPU Speed	Cores	Bus Speed	Power	Cache Size	Package	Acer P/N
E2220	2.4 GHz	2	800	65 W	1MB	LGA	KC.22201.DEM
E5200	2.5 GHz	2	800	65 W	2MB	LGA	KC.52001.DEM
E5300	2.6 GHz	2	800	65 W	2MB	LGA	KC.53001.DEM
E5400	2.7 GHz	2	800	65 W	2MB	LGA	KC.54001.DEM
E6300	2.8 GHz	2	1066	65 W	2 MB	LGA	KC.63001.DEM
E6500	2.93 GHz	2	1066	65 W	2 MB	LGA	KC.65001.DEM
E7300	2.66 GHz	2	1066	65 W	3 MB	LGA	KC.73001.DE0
E7400	2.8 GHz	2	1066	65 W	3 MB	LGA	KC.74001.DE0
E7500	2.93 GHz	2	1066	65 W	3 MB	LGA	KC.75001.DE0
E7600	3.06 GHz	2	1066	65 W	3 MB	LGA	KC.76001.DE0
Q8200s	2.33 GHz	4	1333	65 W	4 MB	LGA	KC.82001.QQS
E8400	3.0 GHz	2	1333	65 W	6 MB	LGA	KC.84001.DEE
Q8400s	2.66 GHz	4	1333	65 W	4 MB	LGA	KC.84001.QQS
E8500	3.16 GHz	2	1333	65 W	6 MB	LGA	KC.85001.DEE
E8600	3.33 GHz	2	1333	65 W	6 MB	LGA	KC.86001.DEE
Q9400s	2.66 GHz	4	1333	65 W	6 MB	LGA	KC.94001.QQS

CPU Fan True Value Table

Step	CPU Temperature		CPU Fan RPM
	FAN on (°C)	FAN off (°C)	
1	45	38	2100
2	50	46	2500
3	58	52	2800
4	64	59	3100
Throttling	68		12
Shut Down	75		12

Step	VGA Temperature		VGA Fan Voltage
	FAN on (°C)	FAN off (°C)	
1	44	38	2500
2	49	45	3000
3	55	50	3600
4	62	58	4000
Throttling	90		12
Shut Down	100		12

BIOS

Item	Specification
BIOS vendor	Phoenix BIOS
BIOS Version	R01-A1
BIOS ROM type	SPI interface to serial flash memory, SOP8 package
BIOS ROM size	8 MB

Item	Specification
Supported protocols	SMBIOS 2.4
BIOS password control	Supervisor only

System Memory

Item	Specification
Memory controller	Built in
Memory size	Non onboard
DIMM socket number	4
Supports memory size per socket	2 GB
Supports maximum memory size	8 GB
Supports DIMM type	DDR3 SDRAM
Supports DIMM Speed	800/1066MHz
Supports DIMM voltage	1.5V

Memory Combinations

Slot 1	Slot 2	Total Memory
0MB	512MB	512MB
0MB	1024MB	1024MB
0MB	2048MB	2048MB
512MB	512MB	1024MB
512MB	1024MB	1536MB
512MB	2048MB	2560MB
1024MB	0MB	1024MB
1024MB	512MB	1536MB
1024MB	1024MB	2048MB
1024MB	2048MB	3072MB
2048MB	0MB	2048MB
2048MB	512MB	2560MB
2048MB	1024MB	3072MB
2048MB	2048MB	4096MB
4096MB	4096MB	8192MB

NOTE: Above table lists some system memory configurations. You may combine DIMMs with various capacities to form other combinations. On above table, the configuration of slot 1 and slot 2 could be reversed.

System Board Major Chips

Item	Controller
Core logic	<ul style="list-style-type: none"> EL8 implement Intel Yorkfield/Wolfdale Processor Eaglelake G45 + ICH10
LAN	RTL8111DL
WLAN	Support Mini PCIE , USB wireless LAN
Audio Codec	ALC888S
Keyboard	ITE8512-NX embedded

NorthBridge Chipset

Item	Specification
Chipset	Eaglelake G45
Features	<ul style="list-style-type: none">• GTL+ interface (Front-side bus)• Support Intel Yorkfield/Wolfdale Processor• 800/1066/1333MHz transfer rate processor bus speed

SouthBridge Chipset

Item	Specification
Chipset	ICH10
Features	<ul style="list-style-type: none">• PCI bus Interface• Supports PCI bus at 33MHz• PCI Rev.2.3 specification support.• Support for 64 bit addressing on PCI using DAC protocol.

Card Reader

Item	Specification
Chipset	JMB385 (SD, SDHC, MMC, MS, MS pro slot)
Features	<ul style="list-style-type: none">• Compliant with PCI Express Base Spec. Revision 1.1• Compliant with SD Spec. Part 1 Physical Layer Spec. Version 2.00• Compliant with SD Spec. Part A2 SD Host Controller Standard Spec. Version 2.00• Compliant with SD Spec. Part E1 SDIO Spec. Version 2.00• Compliant with SD Spec. Part 2 File System Spec. Version 2.00• Compliant with MultiMediaCard System Spec. Version 4.2• Compliant with Memory Stick Standard Format Spec. Version 1.43-00• Compliant with Memory Stick Standard Memory Stick PRO Format Spec. - without security spec. - Version 1.02-00• Compliant with Memory Stick Pro-HG Duo Spec. Version 1.00• Compliant with xD-Picture Card Spec. Version 1.20• Compliant with xD-Picture Card Host Guideline Version 1.20• Compliant with xD-Picture Card Format Spec. Version 1.11

USB 2.0

Item	Specification
Chipset	SB ICH10 embedded
Features	<ul style="list-style-type: none">• USB host interface with support for 12USB ports<ul style="list-style-type: none">• 6 UHCI host controllers• 2 EHCI high-speed USB2.0 Host controller

SATA Interface

Item	Specification
Chipset	ICH10 embedded
Features	<ul style="list-style-type: none">• Fast SATA, 4 ports:<ul style="list-style-type: none">• Support 3.5" HDD via SATA interface• Support SSD HDD via SATA interface• Support ODD via SATA interface• Support eSATA via SATA interface

USB

Item	Specification
Chipset	ICH10 embedded
Features	<ul style="list-style-type: none">Using 6 USB2.0 Ports for Base connectorUsing 1 USB2.0 Port for PCIE/WLANUsing 1 USB2.0 Port for PCIE/TVUsing 1 USB2.0 Port for WebcamUsing 1 USB2.0 Port for BluetoothUsing 1 USB2.0 Port for Touch screen

LAN Interface

Item	Specification
LAN Chipset	Realtek RTL8111DL
Supports LAN protocol	10/100/1000M Fast Ethernet
LAN connector type	RJ-45
LAN connector location	Main Board
Features	<ul style="list-style-type: none">Integrated 10/100/1000N transceiverAuto-Negotiation with Next Page capabilitySupports PCI Express™ 1.1Supports pair swap/polarity/skew correctionCrossover Detection & Auto-CorrectionWake-on-LAN and remote wake-up supportMicrosoft® NDIS5, NDIS6 Checksum Offload (IPv4, IPv6, TCP, UDP) and Segmentation Task-offload (Large send v1 and Large send v2) supportSupports Full Duplex flow control (IEEE 802.3x)Supports jumbo frame to 9K bytesFully compliant with IEEE 802.3, IEEE 802.3u, IEEE 802.3abSupports IEEE 802.1P Layer 2 Priority EncodingSupports IEEE 802.1Q VLAN taggingEmbedded OTP memory can replace the external EEPROMSerial EEPROMTransmit/Receive on-chip buffer supportSupports power down/link down power savingBuilt-in Switching regulatorSupports PCI MSI (Message Signaled Interrupt) and MSI-XSupports quad core Receive-Side Scaling (RSS)Embeds an adaptive equalizer in PCI express PHY (PCB traces to reach 40 inches)Supports Deep Slumber Mode (DSM) power saving featureCustomized LEDs64-pin QFN package (RTL8111D) and 48-pin LQFP (RTL8111DL) Green package

Audio Interface

Item	Specification
Audio Controller	ALC888S
Audio onboard or optional	Onboard
Mono or Stereo	Stereo
Resolution	Wide range (-80 dB ~ +42 dB) volume control with 1.5 dB resolution
Compatibility	EAX 1.0 and 2.0, Direct Sound 3D, I3DL2

Item	Specification
Sampling Rate	<ul style="list-style-type: none">• DACs with 97dB SNR• ADCs with 90dB SNR• Internal Speaker(5WX2)• Line out 5.1 Channel• Head Phone out , MIC In , Digital MIC In• Software Sound Volume Control• Software Beep Volume control
Internal Microphone	Yes

System Utilities

BIOS Setup Utility

The BIOS Setup Utility is a hardware configuration program built into your computer's BIOS (Basic Input/Output System).

Your computer is already properly configured and optimized, and you do not need to run this utility. However, if you encounter configuration problems, you may need to run Setup. Please also refer to Chapter 4 Troubleshooting when problem arises.

To activate the BIOS Utility, press **F2** during POST (when "Press <F2> to enter Setup" message is prompted on the bottom of screen).

Press <F12> during POST to enter multi-boot menu. In this menu, user can change boot device without entering BIOS SETUP Utility.

Navigating the BIOS Utility

There are six menu options: Information, Main, Advanced, Security, Boot, and Exit.

Follow these instructions:

- To choose a menu, use the left and right arrow keys.
- To choose an item, use the up and down arrow keys.
- To change the value of a parameter, press **F5** or **F6**.
- A plus sign (+) indicates the item has sub-items. Press **Enter** to expand this item.
- Press **Esc** while you are in any of the menu options to go to the Exit menu.
- In any menu, you can load default settings by pressing **F9**. You can also press **F10** to save any changes made and exit the BIOS Setup Utility.

NOTE: You can change the value of a parameter if it is enclosed in square brackets. Navigation keys for a particular menu are shown on the bottom of the screen. Help for parameters are found in the Item Specific Help part of the screen. Read this carefully when making changes to parameter values. **Please note that system information is subject to different models.**

Information

The Information screen displays a summary of your computer hardware information.

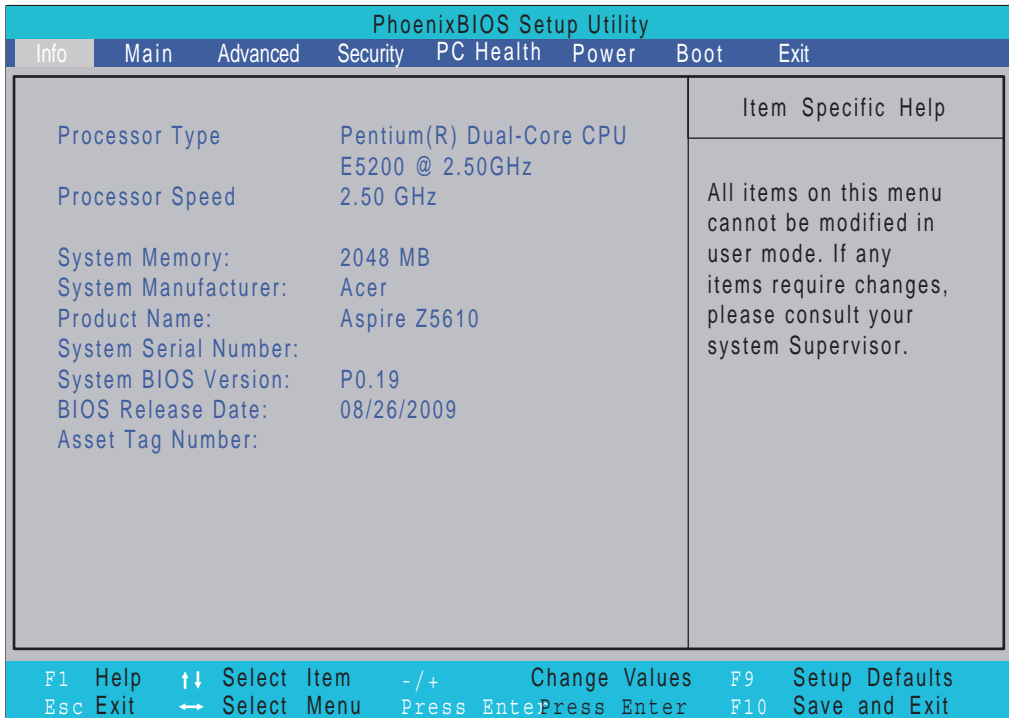

NOTE: The system information is subject to different models.

Parameter	Description
Processor Type	This field shows the system processor type.
Processor Speed	This field shows the speed of the processor.
System Memory	This field reports the memory size of the system. Memory size on this model is fixed to 2048 MB.
System Manufacturer	This field displays the manufacturer of this system.
Product Name	This field shows product name of the system.
System Serial Number	This field displays the serial number of this unit.
System BIOS Version	This field displays system BIOS version.
BIOS Release Date	This field displays the release date of the system BIOS.
Asset Tag Number	This field displays the asset tag number of the system.

Main

The Main screen allows the user to set the system time and date as well as enable and disable boot options.

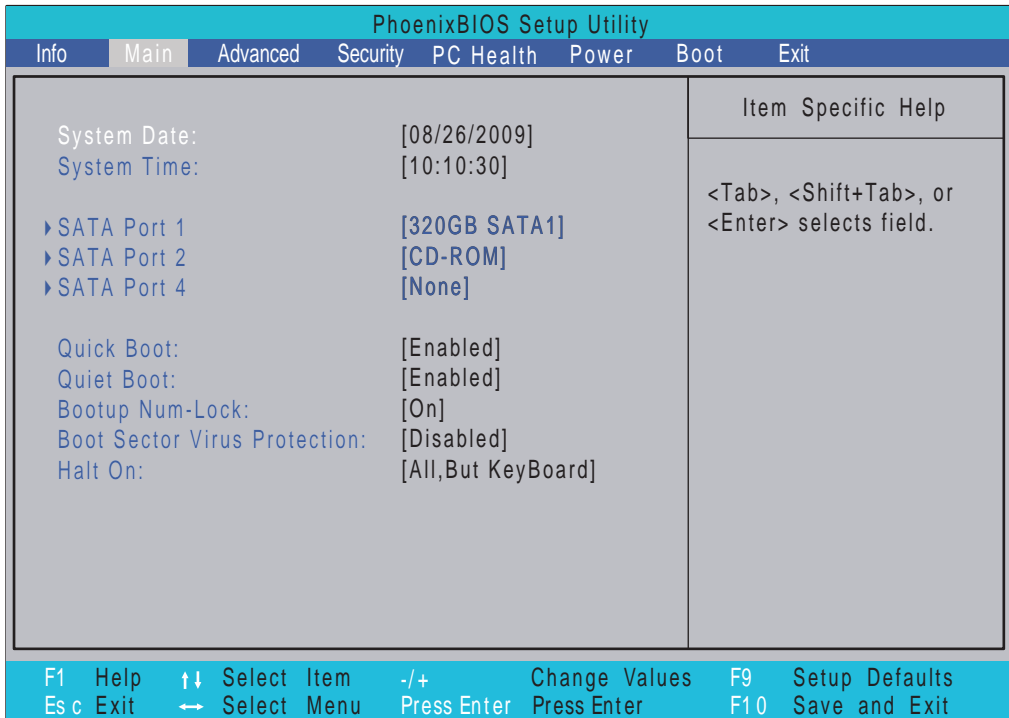

NOTE: The screen above is for your reference only. Actual values may differ.

The table below describes the parameters in this screen. Settings in **boldface** are the default parameter settings.

Parameter	Description	Format/Option
System Date	Sets the system date. NOTE: If a CMOS checksum error or CMOS battery loss occurs, set date to Jan 01 2009.	Format MM/DD/YYYY (month/day/year)
System Time	Sets the system time. The hours are displayed with 24-hour format. NOTE: If a CMOS checksum error or CMOS battery loss occurs, set time to 12:00:00.	Format: HH:MM:SS (hour:minute:second)
SATA Port 1	This field displays SATA type.	N/A
SATA Port 2	This field displays SATA type.	N/A
SATA Port 4	This field displays SATA type.	N/A
Quick Boot	Allows startup to skip certain tests while booting, decreasing the time needed to boot the system.	Option: Enabled or Disabled
Quiet Boot	Allows startup to skip normal POST messages while booting, decreasing the time needed to boot the system.	Option: Enabled or Disabled
Bootup Num Lock	Set Num-Lock to on or off automatically during boot.	Option: Off or On
Boot Sector Virus Protection	Write protects the Boot Sector.	Option: Enabled or Disabled
Halt On	Prompts the user when errors occur during boot up process. NOTE: Selecting All, But KeyBoard halts the system for all errors excluding keyboard errors.	Option: All Errors, No Errors, All, But KeyBoard

SATA Port 1

The SATA Port 1 screen allows the user to view and adjust SATA settings on Port 1.

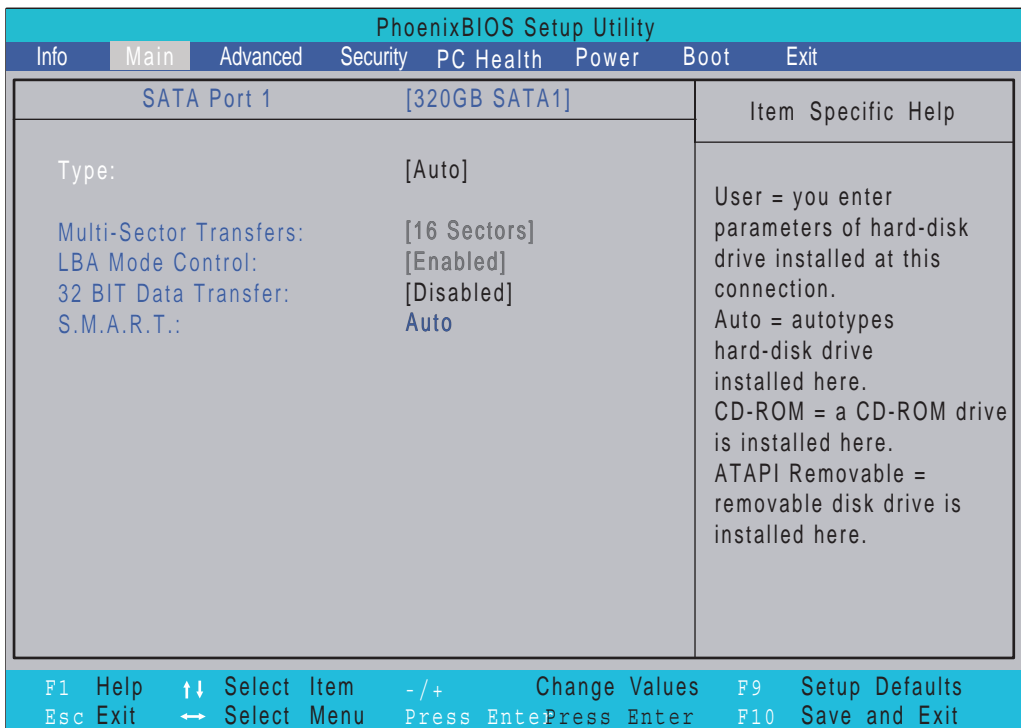

NOTE: The screen above is for your reference only. Actual values may differ.

The table below describes the parameters in this screen. Settings in **boldface** are the default parameter settings.

Parameter	Description	Format/Option
Type	The system automatically detects SATA type.	N/A
Multi Sector Transfers	Allows the system IDE controller to transfer multiple sectors per interrupt.	N/A
LBA Mode Control	The system enables LBA Mode Control by default.	N/A
32Bit Data Transfer	Allows the system 32-bit access to maximize the IDE hard disk data transfer rate.	Option: Disabled or Enabled
S.M.A.R.T.	The system automatically monitors hard disks for indicators of reliability in order to anticipate failures.	N/A

SATA Port 2

The SATA Port 2 screen allows the user to view and adjust SATA settings on Port 2.

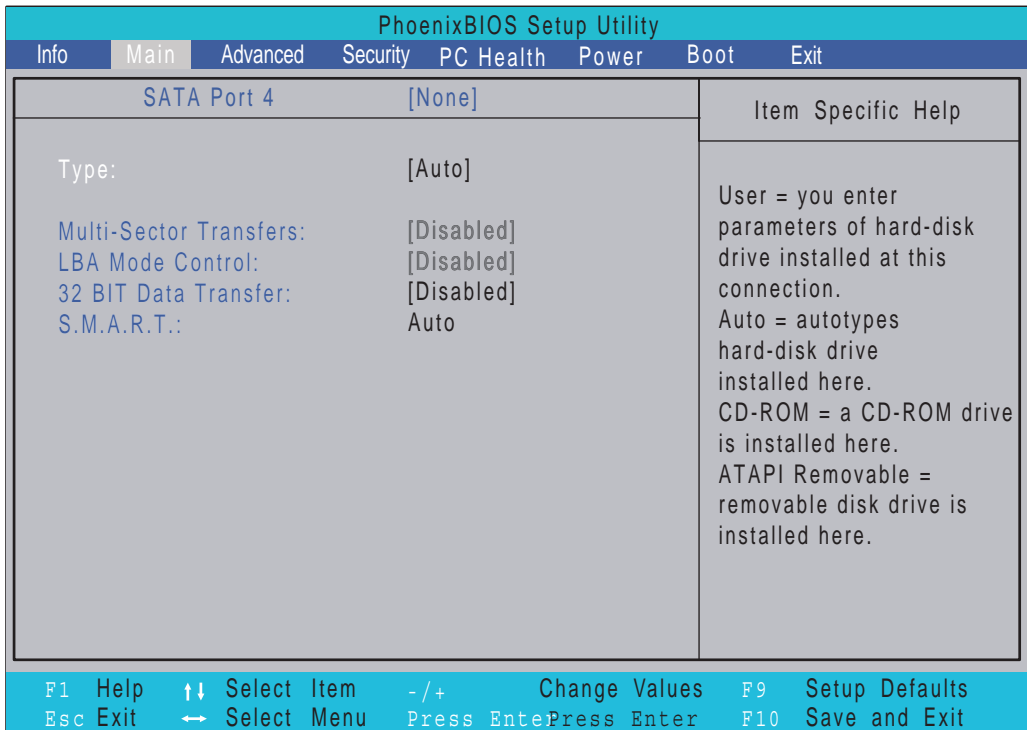

NOTE: The screen above is for your reference only. Actual values may differ.

The table below describes the parameters in this screen. Settings in **boldface** are the default parameter settings.

Parameter	Description	Format/Option
Type	The system automatically detects SATA type.	N/A
Multi Sector Transfers	The system disables Multi Sector Transfers by default.	N/A
LBA Mode Control	The system disables LBA Mode Control by default.	N/A
32Bit Data Transfer	Allows the system 32-bit access to maximize the IDE hard disk data transfer rate.	Option: Disabled or Enabled
S.M.A.R.T.	The system automatically monitors hard disks for indicators of reliability in order to anticipate failures.	N/A

SATA Port 4

The SATA Port 4 screen allows the user to view and adjust SATA settings on Port 4.

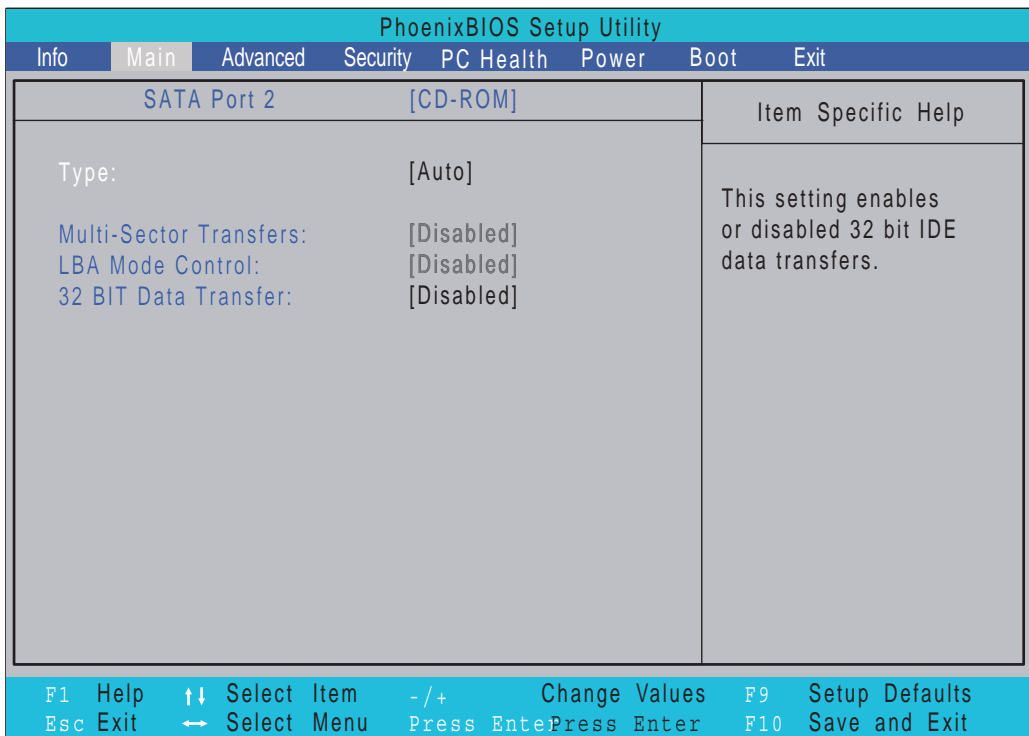

NOTE: The screen above is for your reference only. Actual values may differ.

The table below describes the parameters in this screen. Settings in **boldface** are the default parameter settings.

Parameter	Description	Format/Option
Type	The system automatically detects SATA type.	N/A
Multi Sector Transfers	The system disables Multi Sector Transfers by default.	N/A
LBA Mode Control	The system disables LBA Mode Control by default.	N/A
32Bit Data Transfer	Allows the system 32-bit access to maximize the IDE hard disk data transfer rate.	Option: Disabled or Enabled

Advanced

The Advanced screen allows the user to configure the various advanced BIOS options.

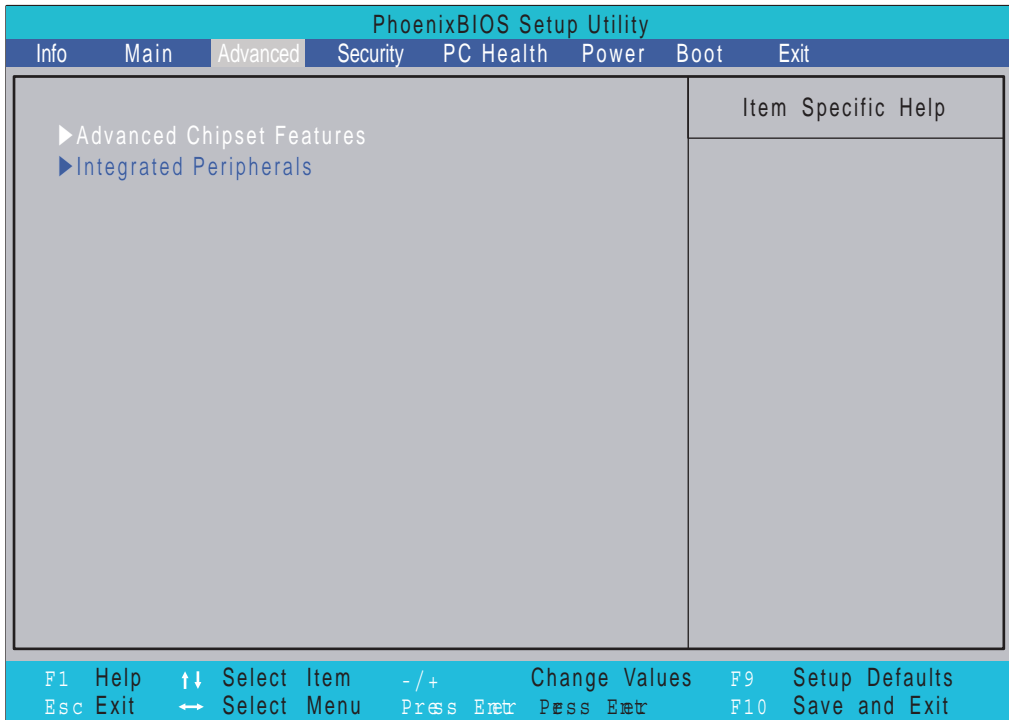

The table below describes the items, menus, and submenus in this screen.

Parameter	Description
Advanced Chipset Features	Enter the Advanced Chipset Features submenu.
Integrated Peripherals	Enter the Integrated Peripherals submenu.

Advanced Chipset Features

The Advanced Chipset screen allows the user to configure chipset settings.

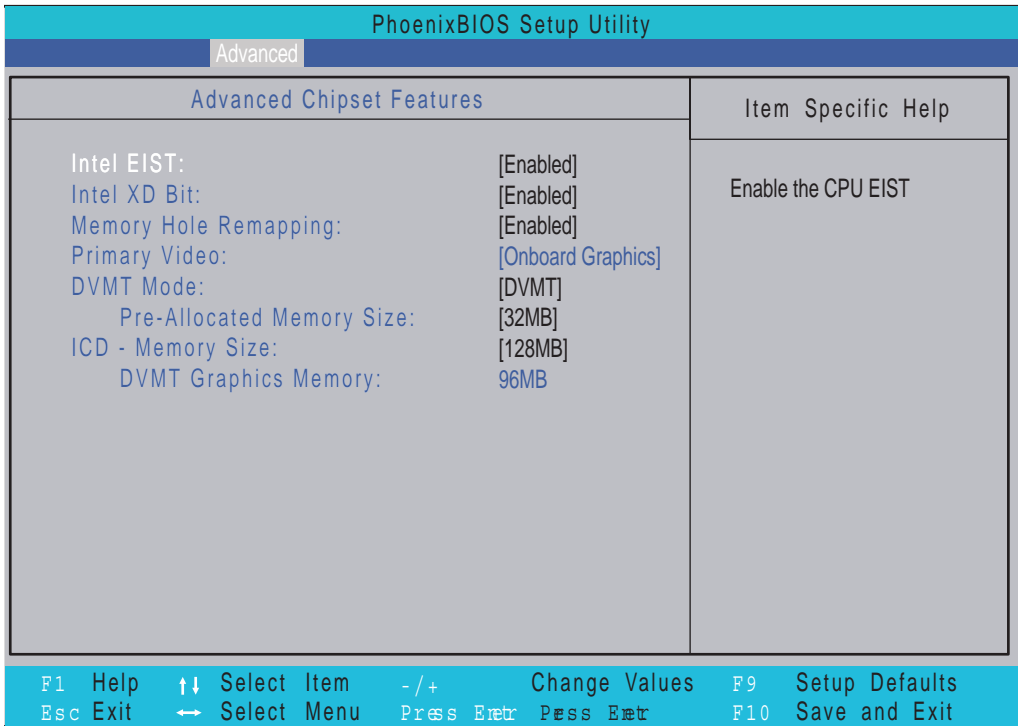

NOTE: The screen above is for your reference only. Actual values may differ.

The table below describes the parameters in this screen. Settings in **boldface** are the default parameter settings

Parameter	Description	Format/Option
Intel EIST	Turns on/off Enhanced Intel SpeedStep® Technology (EIST).	Option: Disabled or Enabled
Intel XD Bit:	Allows the system to distinguish between bits of code that may pose a threat to the system.	Option: Disabled or Enabled
Memory Hole Remapping:	Allows the system to use 4GB of RAM instead of 3GB on a 64-bit OS and processor.	Option: Disabled or Enabled
Primary Video:	This field displays the primary video source.	N/A
DVMT Mode:	Dynamically allocates system memory for use as video memory to ensure the most efficient use of available resources for maximum 2D/3D graphics performance.	N/A
Pre-Allocated Memory Size:	This field allows the user to pre-allocate DVMT memory size.	Option: 32MB /64MB/128MB
ICD - Memory Size:	This field allows the user to allocate ICD memory size.	Option: 128MB /256MB/MaxDVMT
DVMT Graphics Memory	This field displays the size of DVMT Graphics Memory.	N/A

Integrated Peripherals

The Integrated Peripherals screen allows the user to configure various display settings.

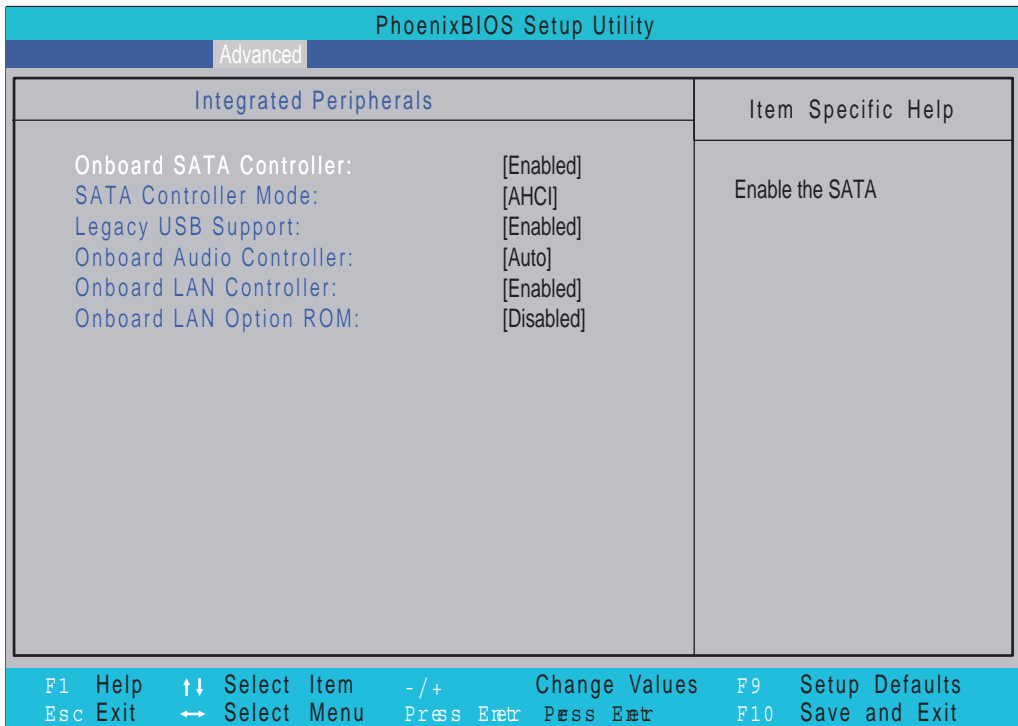

NOTE: The screen above is for your reference only. Actual values may differ.

The table below describes the parameters in this screen. Settings in **boldface** are the default parameter settings

Parameter	Description	Format/Option
Onboard SATA Controller	This field allows the user to enable or disable the Onboard SATA Controller.	Option: Disabled or Enabled
SATA Controller Mode	This field allows the user to select the SATA operation mode.	Option: Enhanced or AHCI
Legacy USB Support	This field allows the user to enable or disable BIOS iteration with a USB keyboard.	Option: Disabled or Enabled
Onboard Audio Controller	This field allows the user to enable or disable the Onboard Audio Controller.	Option: Disabled or Auto
Onboard LAN Controller	This field allows the user to enable or disable the Onboard LAN Controller.	Option: Disabled or Enabled
Onboard LAN Option ROM	This field allows the user to enable or disable the Onboard LAN Option ROM.	Option: Disabled or Enabled

Security

The Security screen contains parameters that help safeguard and protect your computer from unauthorized use.

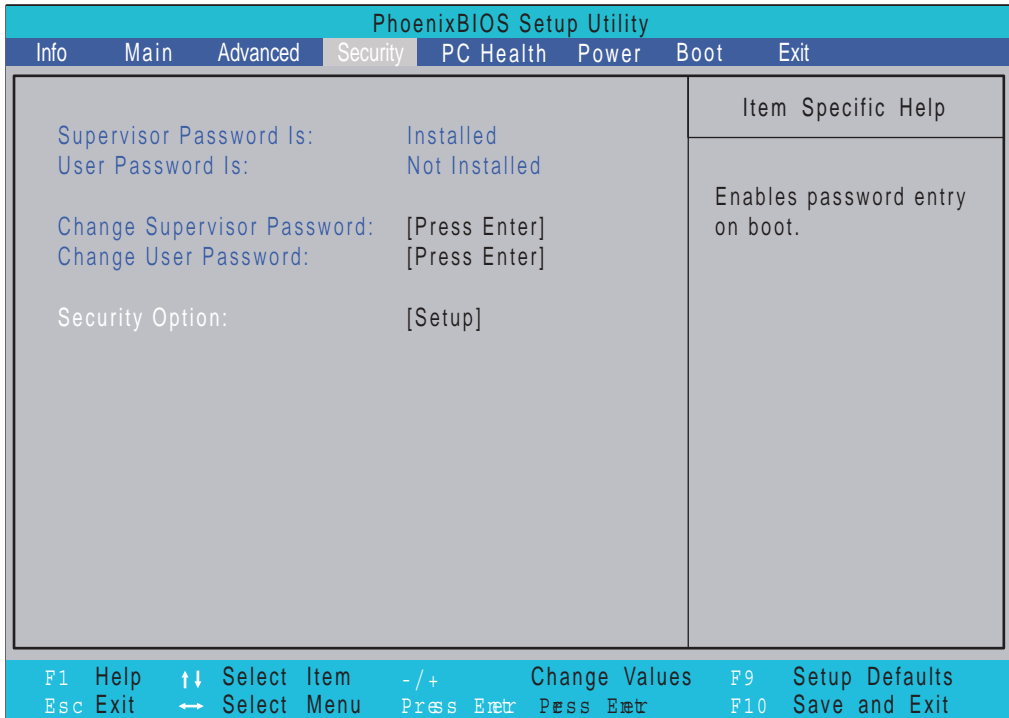

The table below describes the parameters in this screen. Settings in **boldface** are the default and suggested parameter settings.

Parameter	Description	Format/Option
Supervisor Password Is	Shows the setting of the Supervisor password	Option: Not Installed or Installed
User Password Is	Shows the setting of the User password	Option: Not Installed or Installed
Change Supervisor Password	Press Enter to set the supervisor password. When set, this password protects the BIOS Setup Utility from unauthorized access. The user can not either enter the Setup menu nor change the value of parameters.	N/A
Change User Password	Press Enter to set the user password.	N/A
Security Option	Select the desired level of security protection covered by the Supervisor password. Setup enables password security for the BIOS Setup Utility and System enables password security every time the device boots.	Setup or System

NOTE: When you are prompted to enter a password, you have three tries before the system halts. Don't forget your password. If you forget your password, you may have to return your computer to your dealer to reset it.

Setting a Password

Follow these steps as you set the user or the supervisor password:

1. Use the ↑ and ↓ keys to highlight the Set Supervisor Password parameter and press the **Enter** key. The Set Supervisor Password box appears:

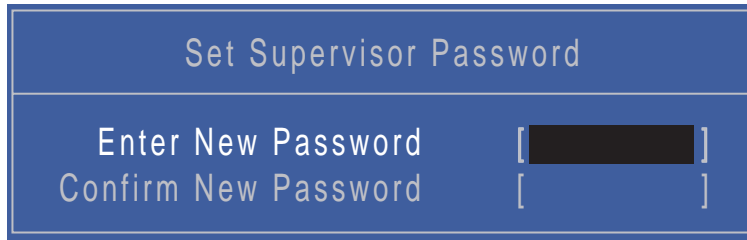

Set Supervisor Password

Enter New Password []

Confirm New Password []

2. Type a password in the “Enter New Password” field. The password length can not exceeds 8 alphanumeric characters (A-Z, a-z, 0-9, not case sensitive). Retype the password in the “Confirm New Password” field.

IMPORTANT: Be very careful when typing your password because the characters do not appear on the screen.

3. Press **Enter**. After setting the password, the computer sets the User Password parameter to “Set”.
4. If desired, you can opt to enable the Password on boot parameter.
5. When you are done, press F10 to save the changes and exit the BIOS Setup Utility.

Removing a Password

Follow these steps:

1. Use the ↑ and ↓ keys to highlight the Set Supervisor Password parameter and press the **Enter** key. The Set Password box appears:



Set Supervisor Password

Enter Current Password []

Enter New Password []

Confirm New Password []

2. Type the current password in the Enter Current Password field and press **Enter**.
3. Press **Enter** twice **without** typing anything in the Enter New Password and Confirm New Password fields. The computer then sets the Supervisor Password parameter to “Clear”.
4. When you have changed the settings, press u to save the changes and exit the BIOS Setup Utility.

Changing a Password

1. Use the ↑ and ↓ keys to highlight the Set Supervisor Password parameter and press the **Enter** key. The Set Password box appears.



The screenshot shows a blue-themed BIOS screen titled "Set Supervisor Password". It contains three input fields, each with a cursor and a pair of square brackets: "Enter Current Password", "Enter New Password", and "Confirm New Password". The first field contains a blacked-out password.

2. Type the current password in the Enter Current Password field and press **Enter**.
3. Type a password in the Enter New Password field. Retype the password in the Confirm New Password field.
4. Press **Enter**. After setting the password, the computer sets the User Password parameter to "Set".
5. If desired, you can enable the Password on boot parameter.
6. When you are done, press F10 to save the changes and exit the BIOS Setup Utility.

If the verification is OK, the screen will display as following.

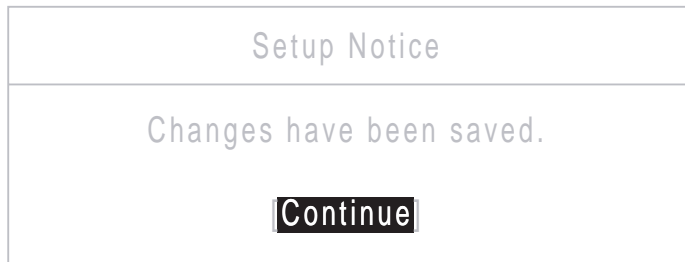

The screenshot shows a white BIOS screen titled "Setup Notice". The text "Changes have been saved." is displayed in the center. Below it, the word "Continue" is highlighted with a black background and white text.

The password setting is complete after the user presses **Enter**.

If the current password entered does not match the actual current password, the screen will show you the Setup Warning.



The screenshot shows a white BIOS screen titled "Setup Warning" in red text. Below the title, the text "Invalid Password." is displayed in red. At the bottom, the word "Continue" is highlighted with a black background and white text.

If the new password and confirm new password strings do not match, the screen will display the following message.



The screenshot shows a white BIOS screen titled "Setup Warning" in red text. Below the title, the text "Passwords do not match. Re-enter password." is displayed in red. At the bottom, the word "Continue" is highlighted with a black background and white text.

PC Health

The PC Health screen displays CPU/Chipset temperature information and contains customizable safety monitors for the CPU.

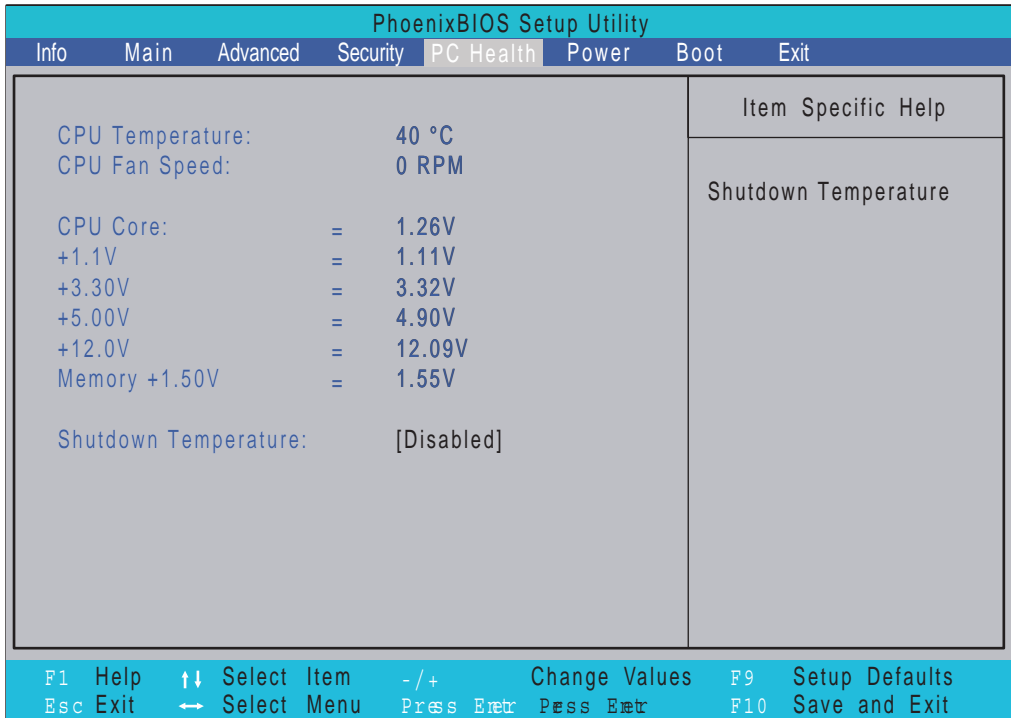

The table below describes the parameters in this screen. Settings in **boldface** are the default and suggested parameter settings.

Parameter	Description	Option
CPU Temperature	This field displays the current CPU temperature (°C).	N/A
CPU Fan Speed	This field displays the current CPU Fan Speed (RPM).	N/A
CPU Core	This field displays the current CPU Core.	N/A
+1.1V	This field displays measured voltage at the nominal 1.1V bus.	N/A
+3.30V	This field displays measured voltage at the nominal 3.30V bus.	N/A
+5.00V	This field displays measured voltage at the nominal 5.00V bus.	N/A
+12.0V	This field displays measured voltage at the nominal 12.0V bus.	N/A
Memory +1.50V	This field displays the memory voltage.	N/A
Shutdown Temperature	This field allows the user to enable or disable CPU shutdown at a certain temperature.	Option: Enabled or Disabled

Power

The Power screen contains parameters used for device power management.

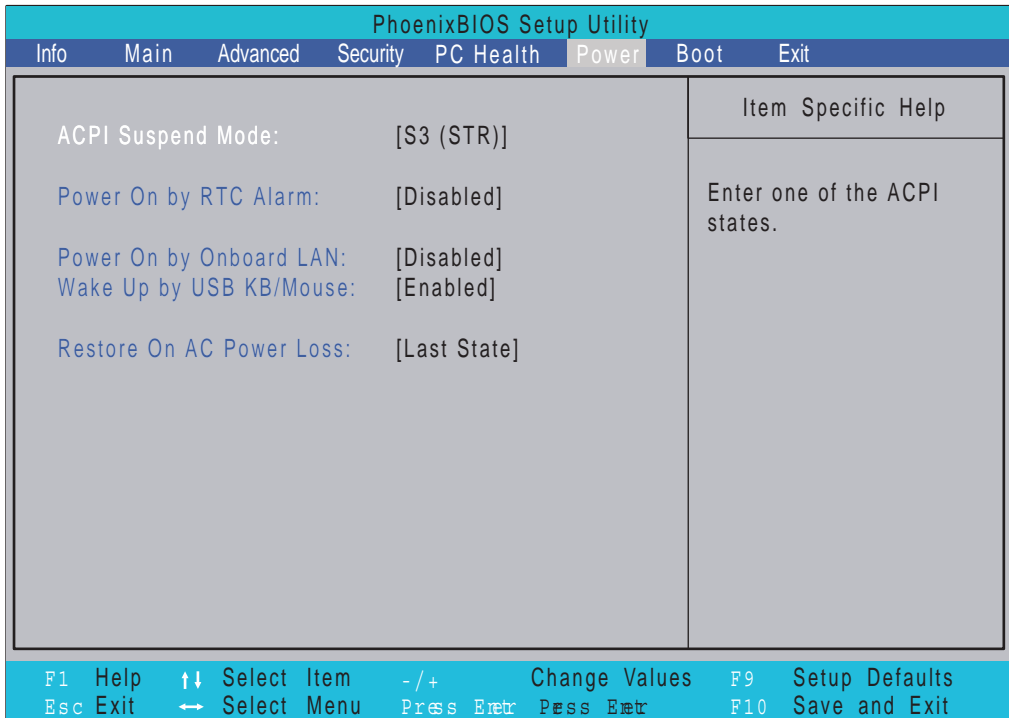

The table below describes the parameters in this screen. Settings in **boldface** are the default and suggested parameter settings.

Parameter	Description	Option
ACPI Suspend Mode	This field allows the user to set the ACPI Suspend Mode.	Option: S1(POS)/ S3 (STR)
Power On by RTC Alarm	This field allows the user to disable or enable auto wake up at a fixed time everyday.	Option: Disabled or Enabled
Power On by Onboard LAN	This field allows the user to disable or enable wake up when the system power is off and a LAN device is activated.	Option: Disabled or Enabled
Wake Up by USB KB/ Mouse	This field allows the user to disable or enable wake up when the system is in standby and a USB device is activated.	Option: Enabled or Disabled
Restore On AC Power Loss	Set the state the device returns to in the event of AC power loss. Off causes the device to remain off in the event of power loss and On restarts the device when AC power resumes.	Option: On/Off/ Last State

Boot

This menu allows the user to decide the order of boot devices to load the operating system. Bootable devices includes the USB diskette drives, the onboard hard disk drive and the DVD drive.

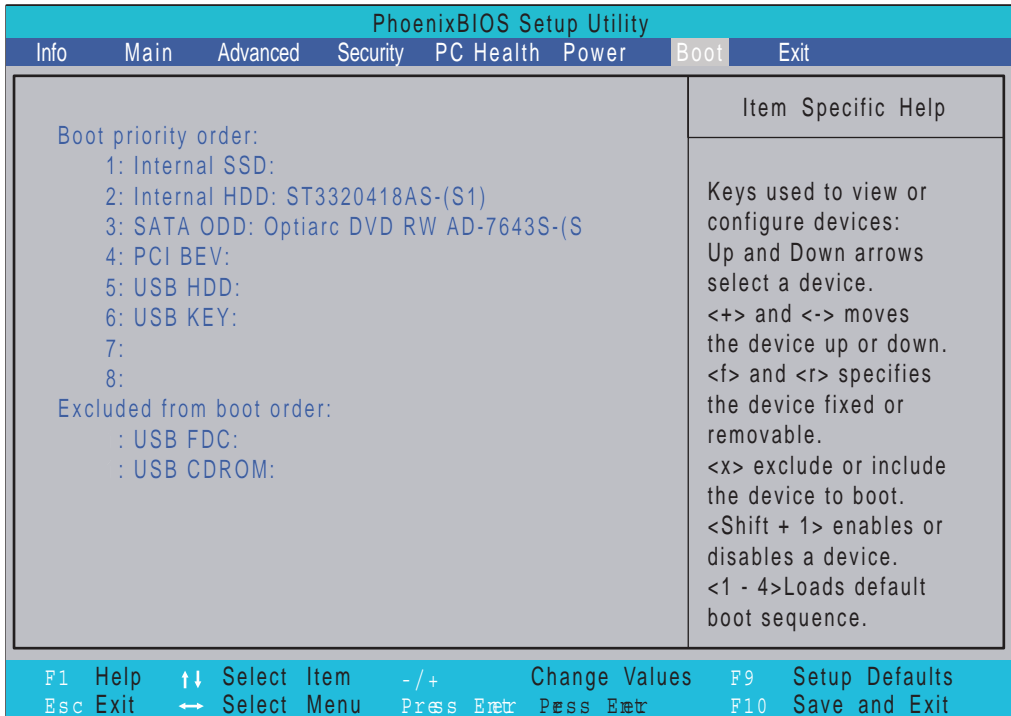

Exit

The Exit screen allows you to save or discard any changes you made and quit the BIOS Utility.

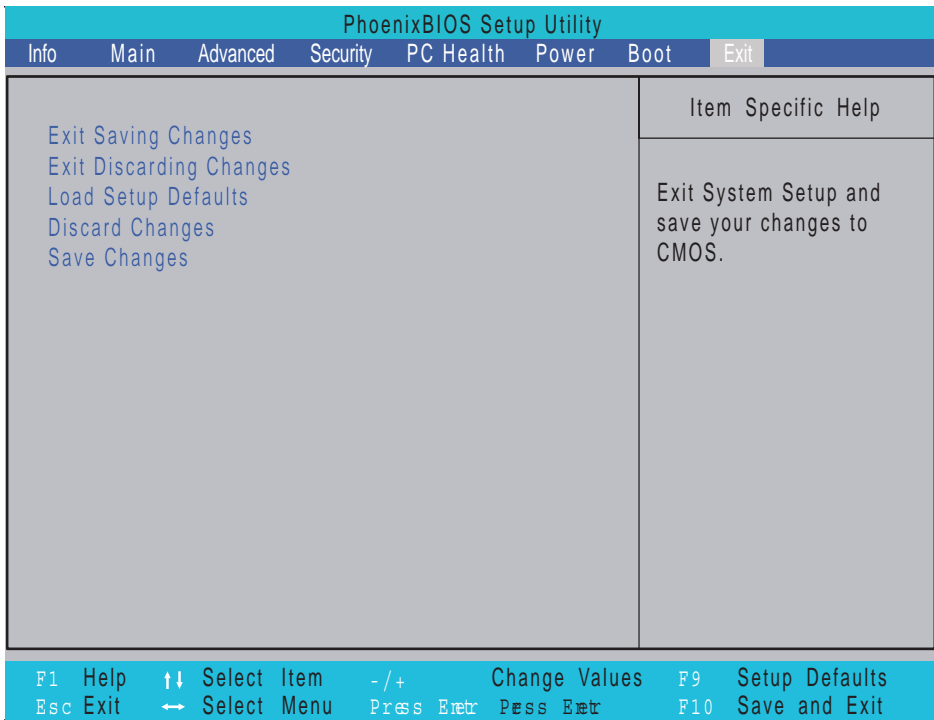

The table below describes the parameters in this screen.

Parameter	Description
Exit Saving Changes	Exit System Setup and save your changes to CMOS.
Exit Discarding Changes	Exit utility without saving setup data to CMOS.
Load Setup Default	Load default values for all SETUP item.
Discard Changes	Load previous values from CMOS for all SETUP items.
Save Changes	Save Setup Data to CMOS.

Machine Disassembly and Replacement

IMPORTANT: The outside housing and color may vary from the mass produced model.

This chapter contains step-by-step procedures on how to disassemble the computer for maintenance and troubleshooting.

Disassembly Requirements

To disassemble the computer, you need the following tools:

- Wrist grounding strap and conductive mat for preventing electrostatic discharge
- Flat screwdriver
- Philips screwdriver

NOTE: The screws for the different components vary in size. During the disassembly process, group the screws with the corresponding components to avoid mismatch when putting back the components.

General Information

Pre-disassembly Instructions

Before proceeding with the disassembly procedure, make sure that you do the following:

1. Turn off the power to the system and all peripherals.
2. Unplug the AC adapter and all power and signal cables from the system.
3. Place the system on a flat, stable surface.

The flowchart provided in the succeeding disassembly section illustrates the entire disassembly sequence. Observe the order of the sequence to avoid damage to any of the hardware components.

Main Screw List

Screw	Quantity	Part Number
M3.0*5.0-B		
M3.0*6.0-C		
M3.0*10-P		
M3.0*15-P		
M2.5*5.0-I		
M2.0*3.0-I		
6-32UNC*5-B		

Disassembly Process

Disassembly Flowchart

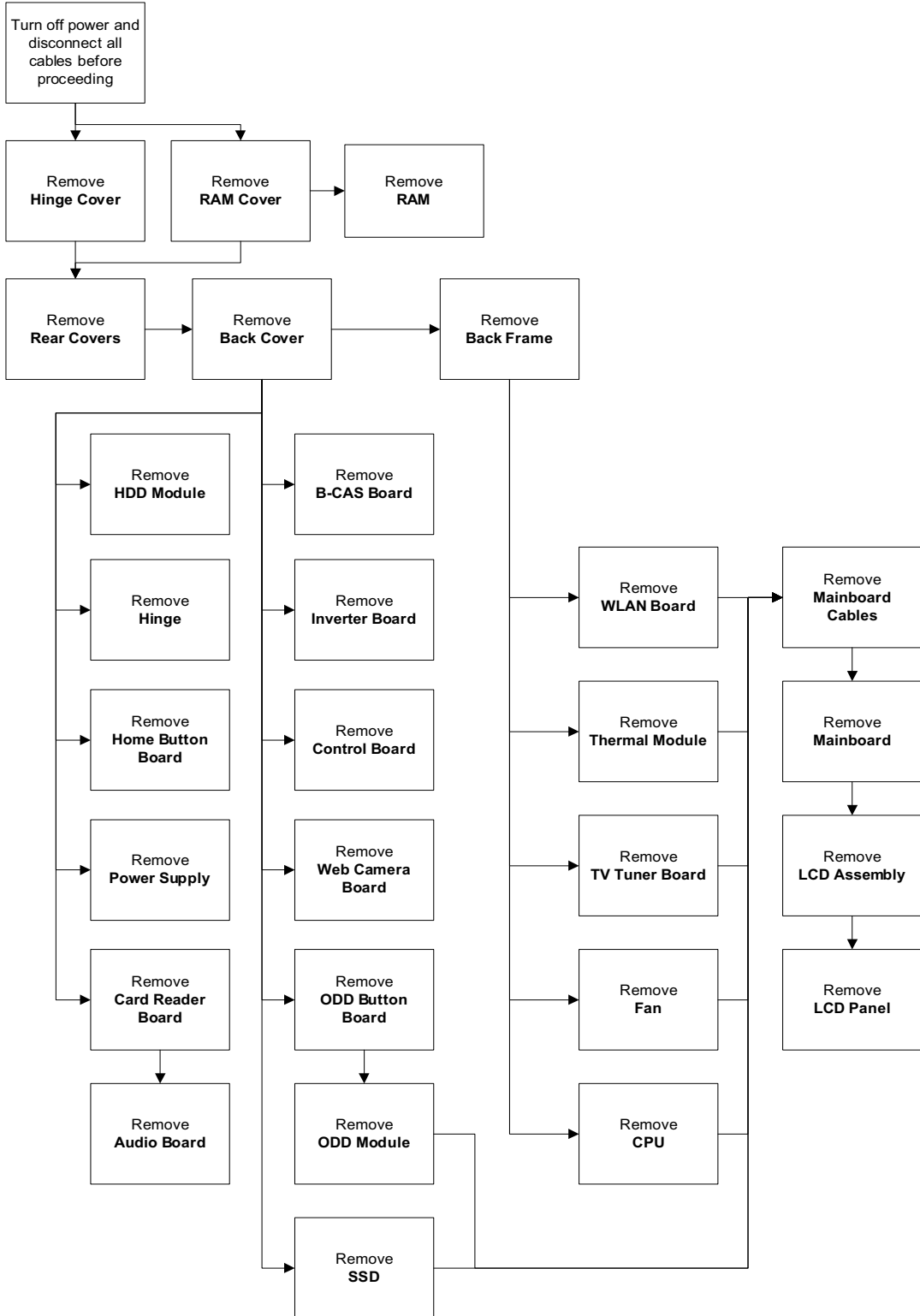

Removing the RAM Cover

1. See "Pre-disassembly Instructions" on page 33.
2. Apply pressure to one end of the RAM Cover, while pulling up with the opposite hand as shown.

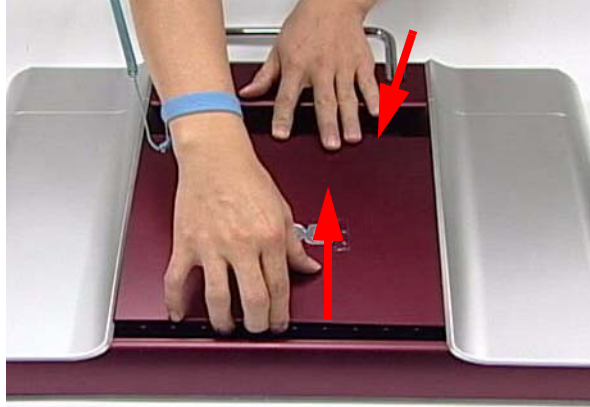

3. Lift the RAM Cover clear of the device.



Removing the Hinge Cover

1. See "Removing the RAM Cover" on page 35.
2. Grasp the Hinge Cover with both hands.

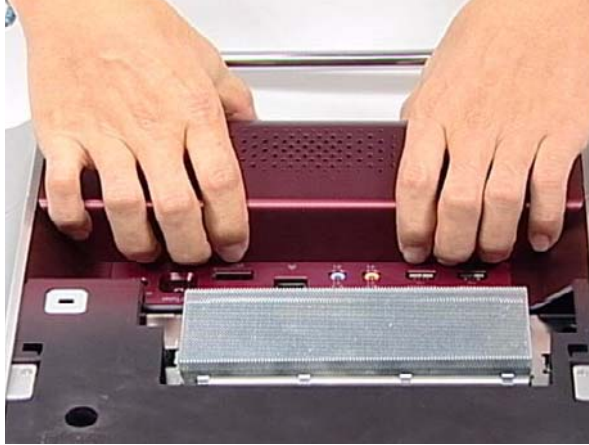

3. Lift the Hinge Cover clear of the device.

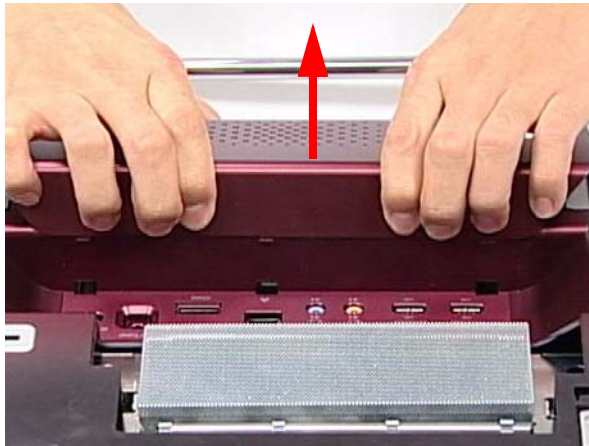

Removing the RAM

1. See “Removing the Hinge Cover” on page 36.
2. Lift the RAM Shielding clear of the device.

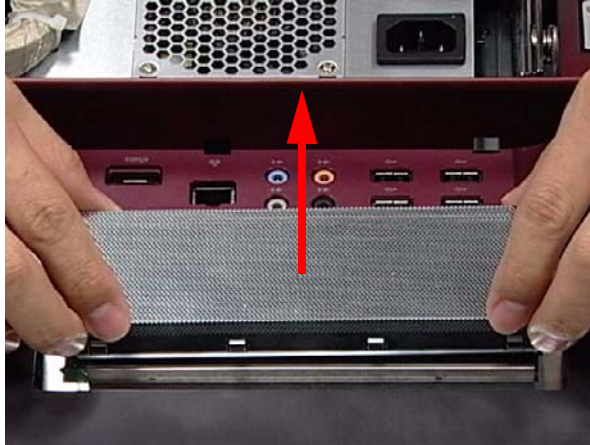

3. Unlock the latches on either side of the RAM by pressing down as shown. There is an audible click when the latch is unlocked.

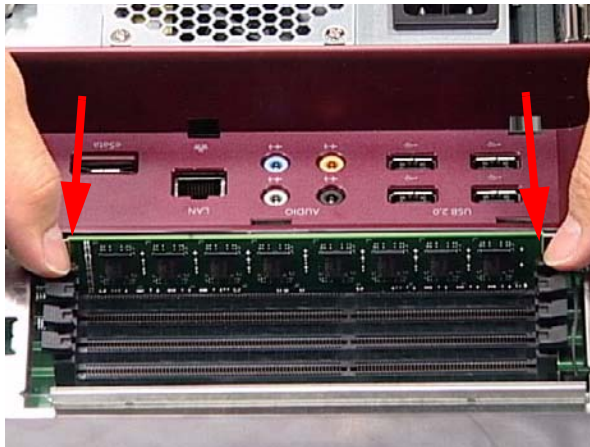

4. Lift each RAM module from its slot.

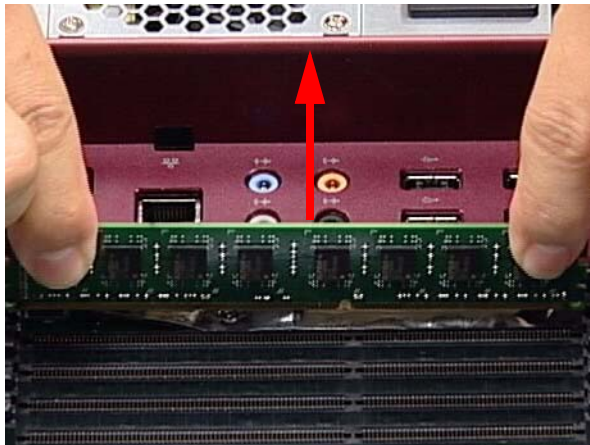

Removing the Rear Covers

1. See "Removing the RAM" on page 37.
2. Remove the six (6) screws that secure the Rear Covers.

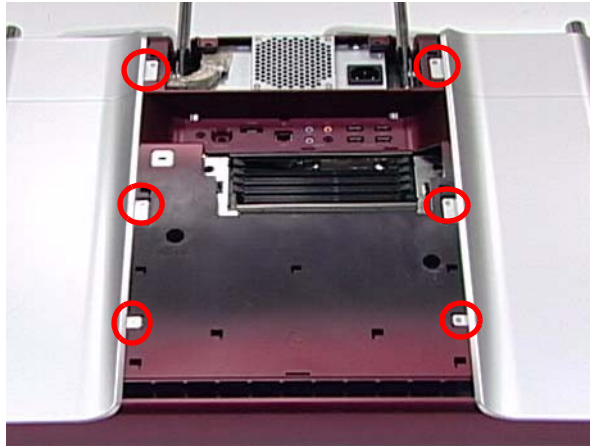

Step	Size	Quantity	Screw Type
Rear Covers		6	

3. Use both hands to gently push the rear cover outward from the device as shown.

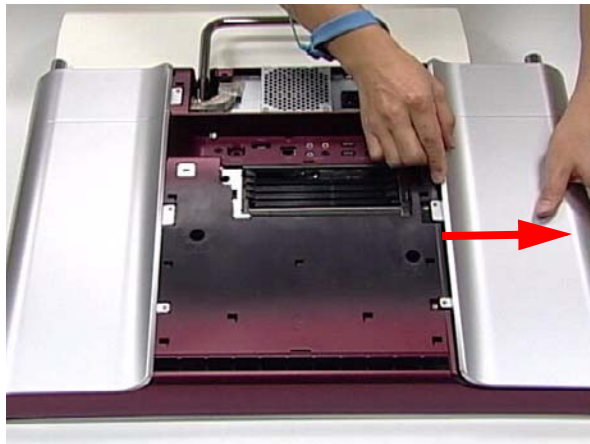

4. Repeat the previous step for the remaining rear cover.

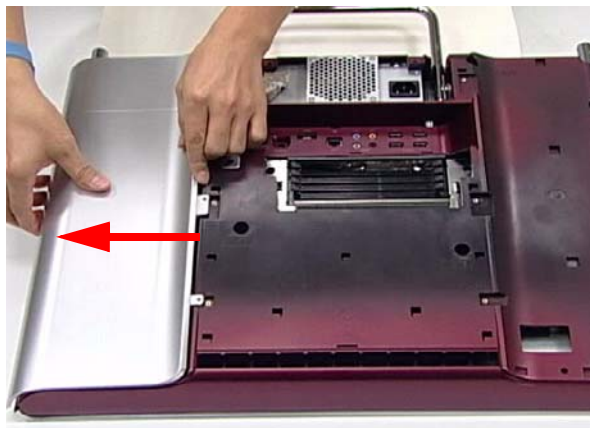

Removing the Back Cover

1. See "Removing the Rear Covers" on page 38.
2. Remove the fourteen (14) screws securing the Back Cover.

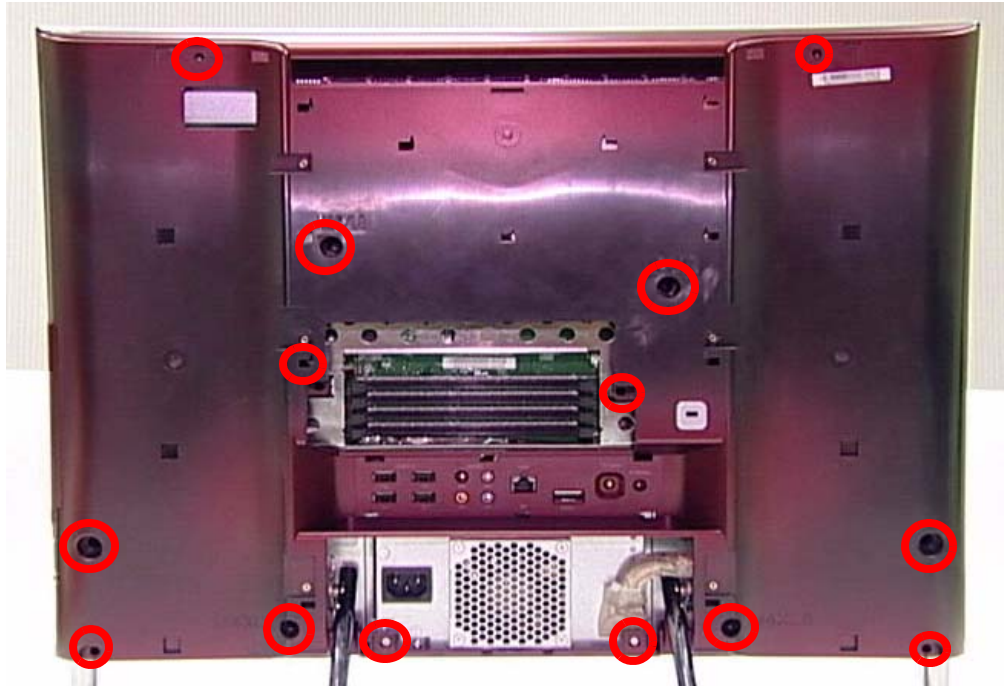

Step	Size	Quantity	Screw Type
Back Cover		14	

3. Use both hands to move the Hinge up into the stand position. There is an audible click when the Hinge is locked in position.

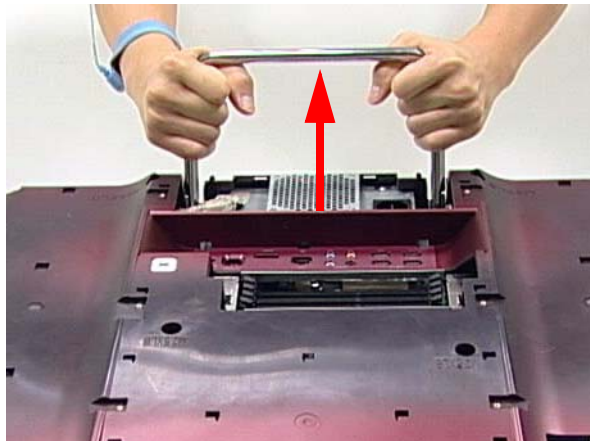

NOTE: In order to lift the Back Cover away, the Hinge must be in the stand position.

4. Place one hand firmly on the Back Cover. Use the opposite hand to pry the Bezel away, working from one corner to the other as shown. Repeat this step until all guides along the bottom of the device are unlocked.



5. Place one hand firmly on the Hinge. Use the opposite hand to pull the top of the Back Cover away from the Bezel, working from one corner to the other as shown. Repeat this step until all guides along the top of the device are unlocked.

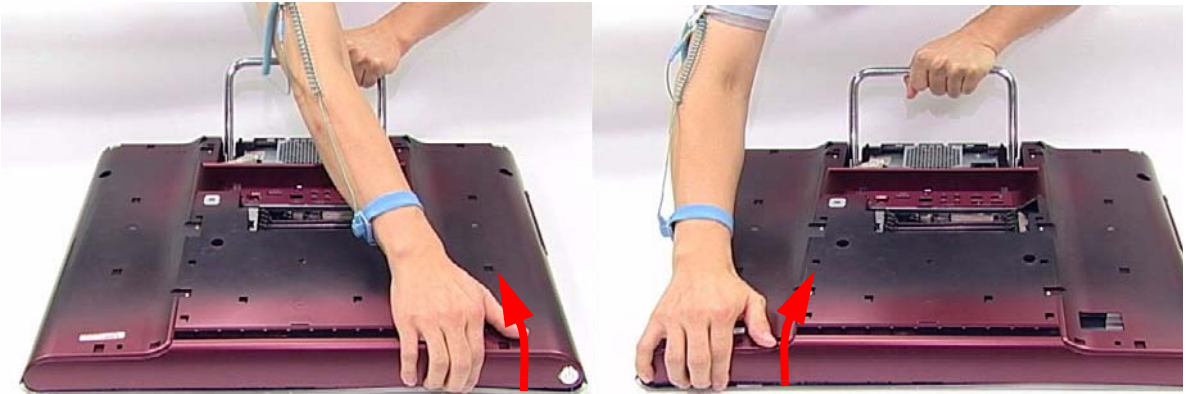

6. Lift the Back Cover clear of the device.

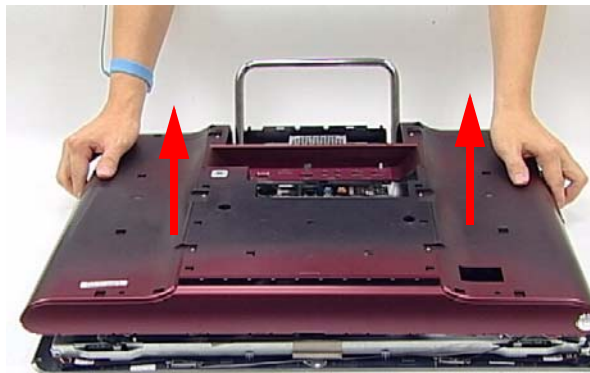

Removing the Hinge

1. See "Removing the Back Cover" on page 39.
2. Replace the Hinge to the carry position.
3. Remove the six (6) screws securing the Hinge.

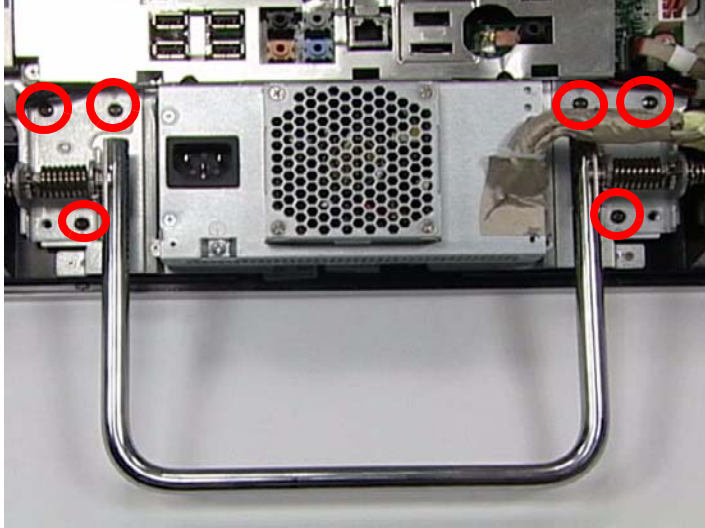

Step	Size	Quantity	Screw Type
Hinge		6	

4. Lift the Hinge clear of the device.

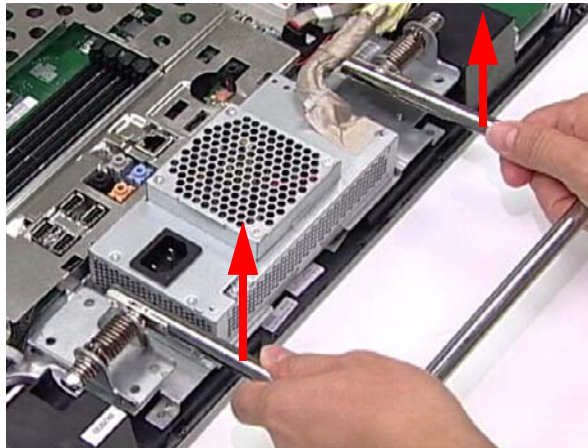

Removing the Back Frame

1. See "Removing the Hinge" on page 41.
2. Unstick the EMI Cable Mylar as shown.

CAUTION: Do not remove the EMI Cable completely; the cable is still attached to the device.

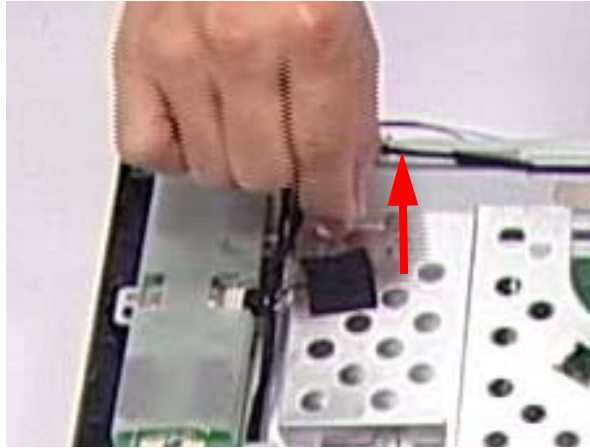

3. Disconnect the CPU Power Cable (A), the SATA Power Cable (B), and the HDD Power Cable (C) as shown:

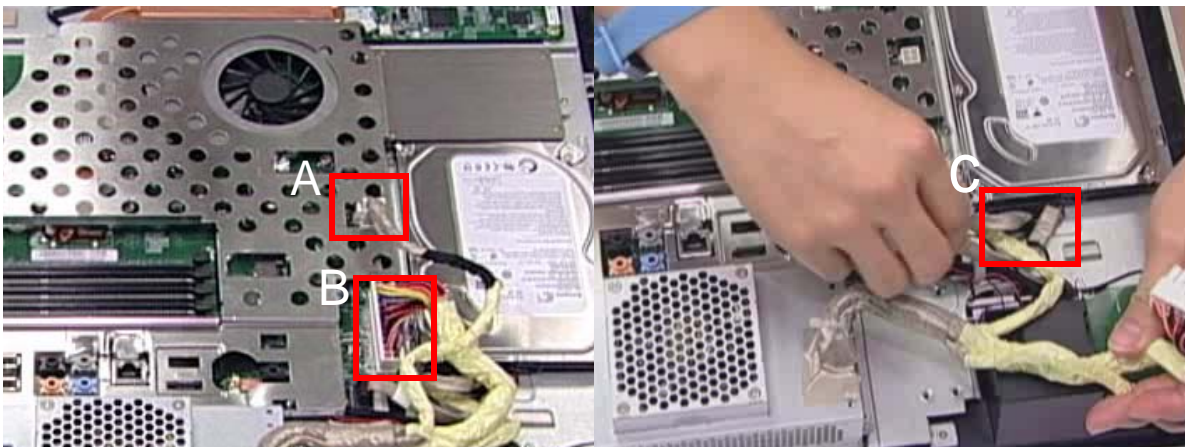

4. Remove the nine (9) screws securing the Back Frame.

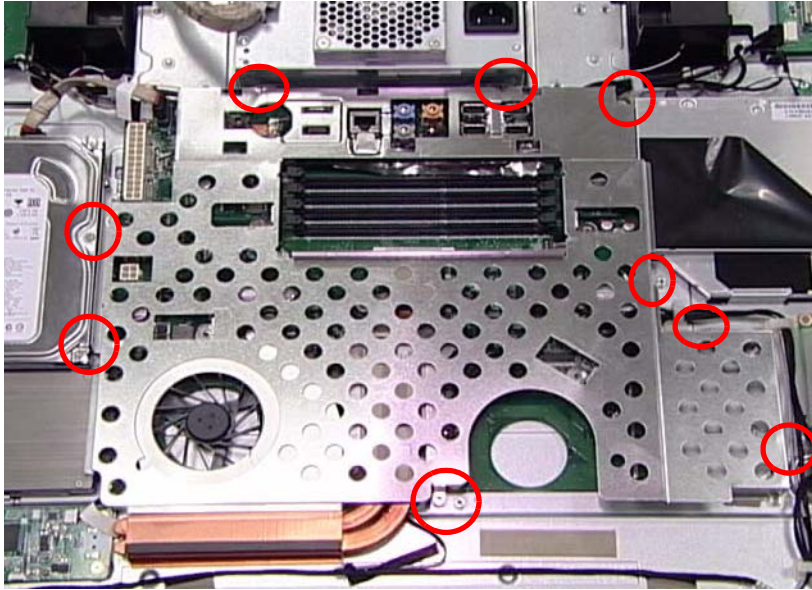

Step	Size	Quantity	Screw Type
Back Frame		9	

5. Lift one end of the Back Frame as shown.

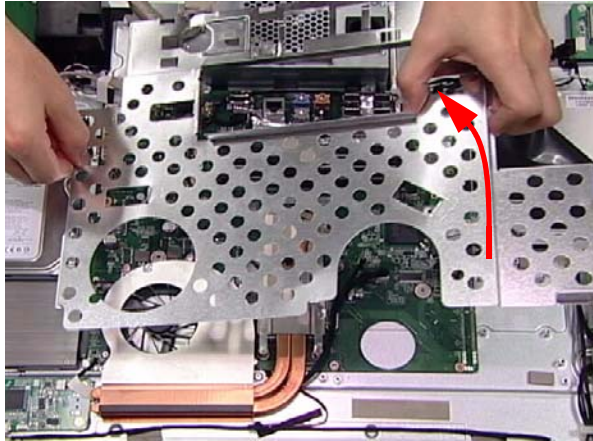

6. Carefully unhook the guide at the opposite end before lifting away completely.

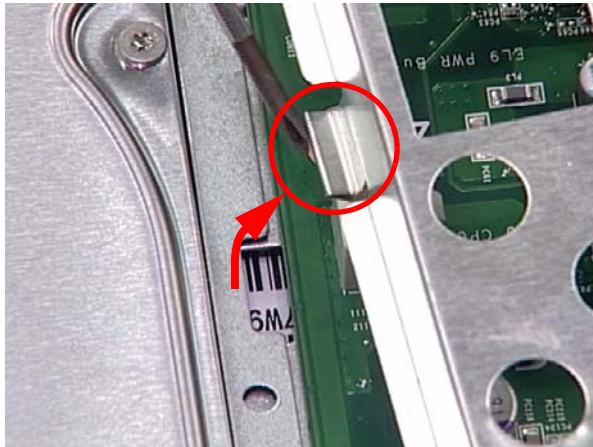

Removing the Power Supply

1. See "Removing the Back Frame" on page 42.
2. Remove two (2) screws securing the Power Supply as shown.

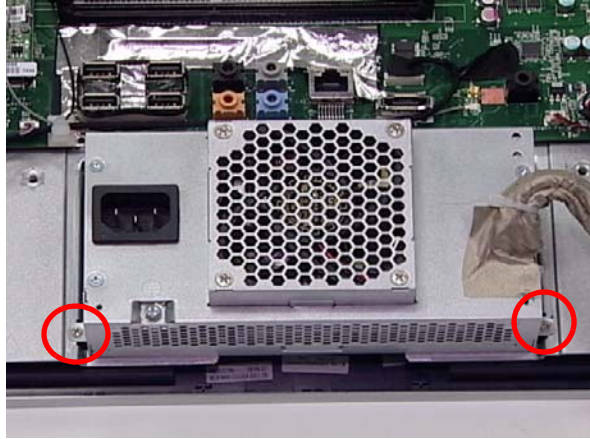

Step	Size	Quantity	Screw Type
Power Supply		2	

3. Lift the Power Supply clear of the device.

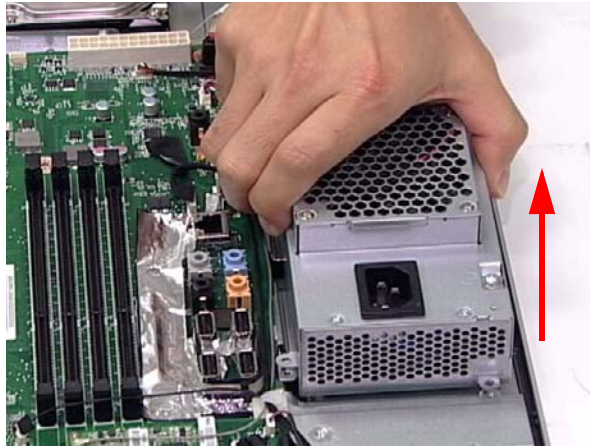

Removing the HDD Module

1. See "Removing the Power Supply" on page 44.
2. Disconnect the HDD Cable as shown.



3. Remove two (2) screws securing the HDD Module.



Step	Size	Quantity	Screw Type
HDD Module		2	

4. Slide the HDD Module out of the flanges.

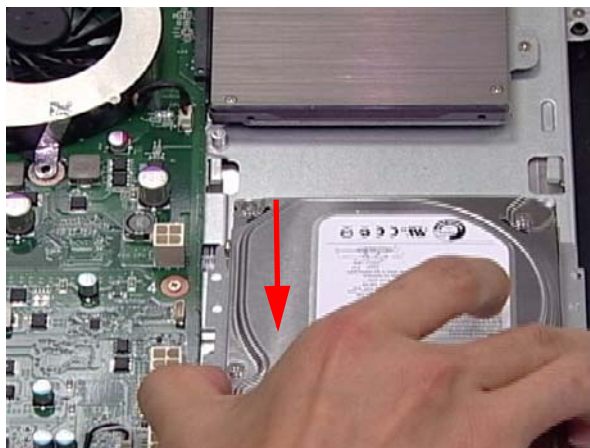

Removing the B-CAS Board

1. See "Removing the HDD Module" on page 45.
2. Remove the three (3) screws securing the B-CAS Board.

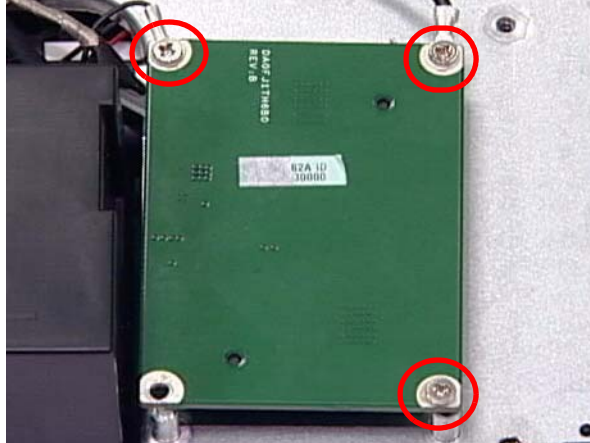

Step	Size	Quantity	Screw Type
B-CAS		3	

3. Lift out the B-CAS Board and turn it over. Disconnect the B-CAS Board Cable underneath.

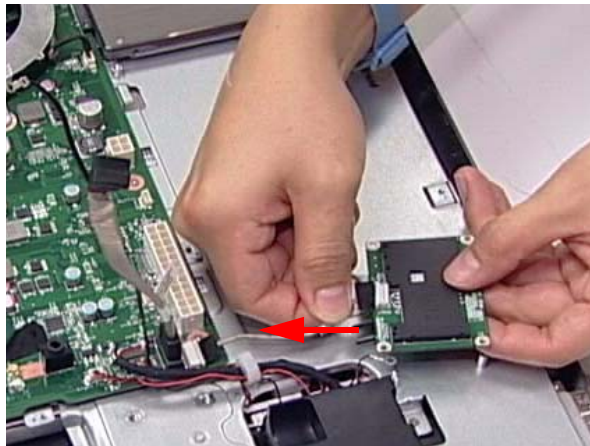

Removing the SSD Module

1. See “Removing the B-CAS Board” on page 46.
2. Remove one (1) screw securing the SSD Module as shown.



Step	Size	Quantity	Screw Type
SSD Module		1	

3. Slide the SSD out of the flange.



Removing the Control Board

1. See "Removing the SSD Module" on page 47.
2. Disconnect three (3) cables on the Control Board as shown

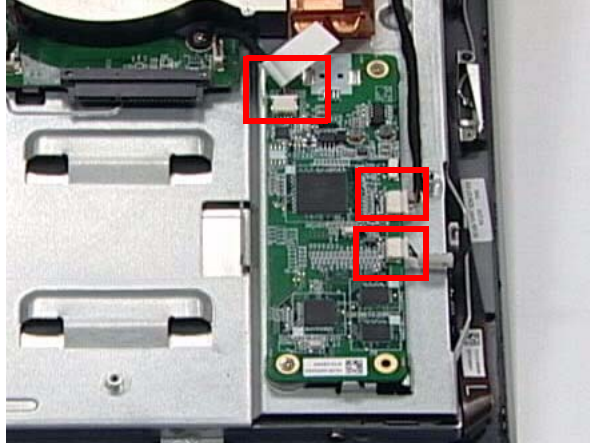

3. Remove the two (2) screws securing the Control Board as shown.

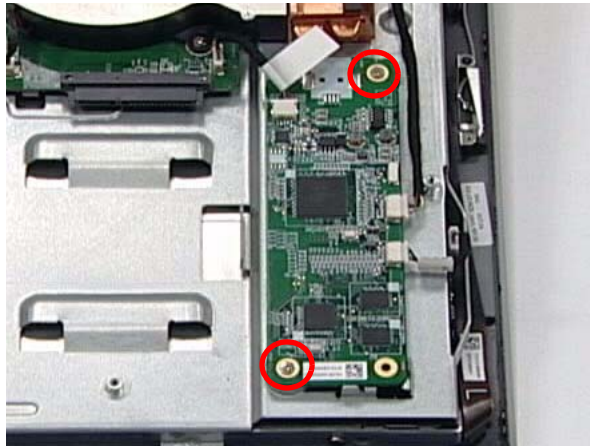

Step	Size	Quantity	Screw Type
Control Board		2	

4. Lift the Control Board clear of the device.

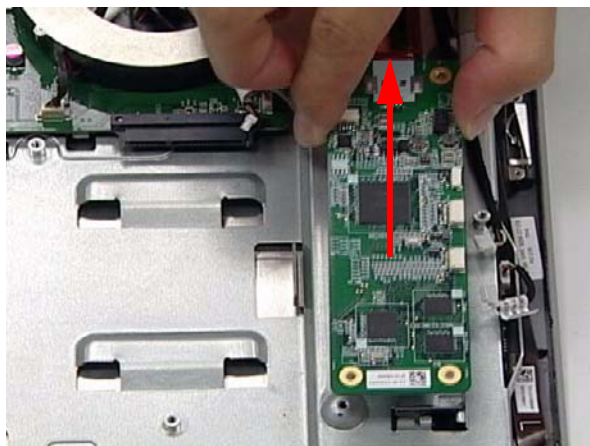

Removing the Card Reader Board

1. See "Removing the Control Board" on page 48.
2. Disconnect the Card Reader Board Cable.

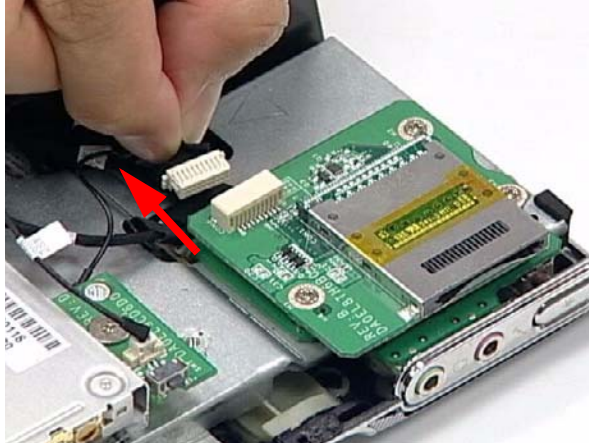

3. Remove three (3) securing screws from the Card Reader Board.

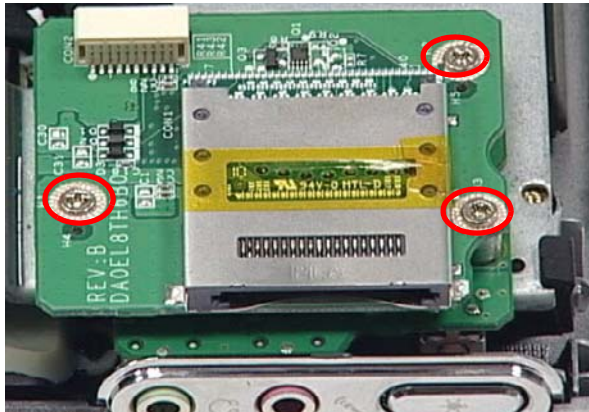

Step	Size	Quantity	Screw Type
Card Reader Board		3	

4. Lift the Card Reader Board clear of the device.

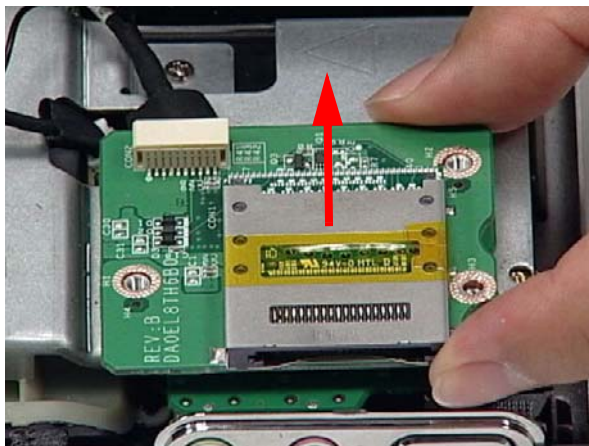

Removing the Audio Board

1. See “Removing the Card Reader Board” on page 49.
2. Disconnect the Audio Board Cable.

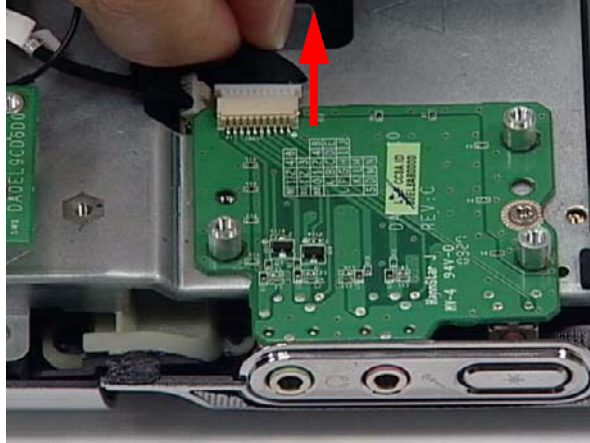

3. Remove one (1) screw from the Audio Board.

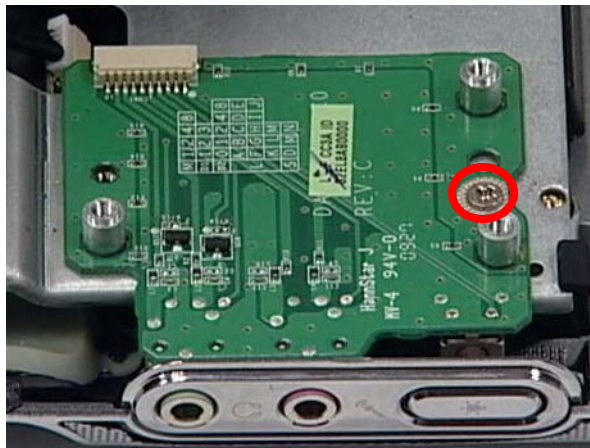

Step	Size	Quantity	Screw Type
Audio Board		1	

4. Carefully remove the Audio Board by separating it from the bracket and three guide pins as shown.

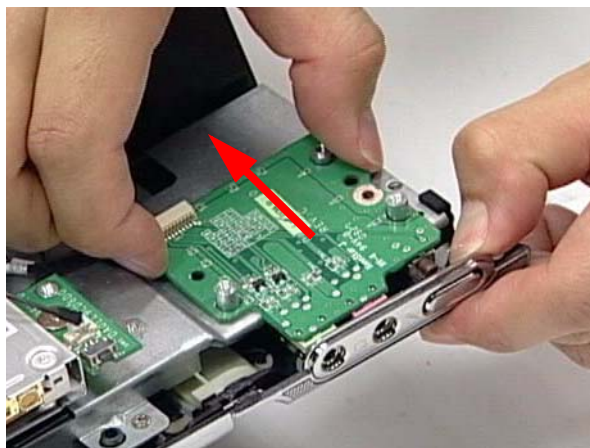

Removing the ODD Button Board

1. See "Removing the Audio Board" on page 50.
2. Remove one (1) securing screw from the ODD Button Board.



Step	Size	Quantity	Screw Type
ODD Button Board		1	

3. Disconnect one (1) cable from the ODD Button Board.



4. Lift the ODD Button Board clear of the device.



Removing the ODD Module

1. See "Removing the ODD Button Board" on page 51.
2. Remove two (2) securing screws from the ODD Module.



Step	Size	Quantity	Screw Type
ODD Module		2	

3. Slide the ODD Module out of the flange.

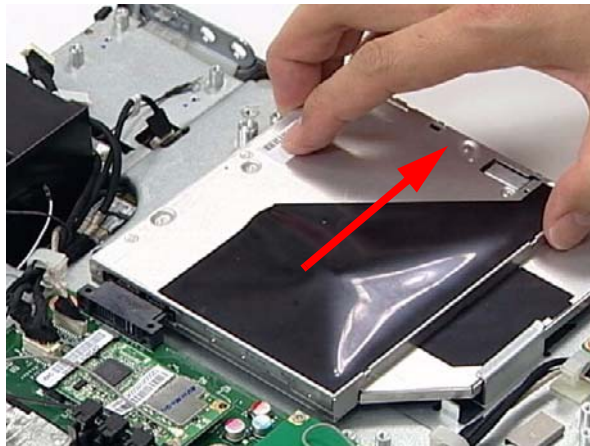

Removing the Inverter Board

1. See "Removing the ODD Module" on page 52.
2. Carefully disconnect both Inverter Cables from either side of the Inverter Board.

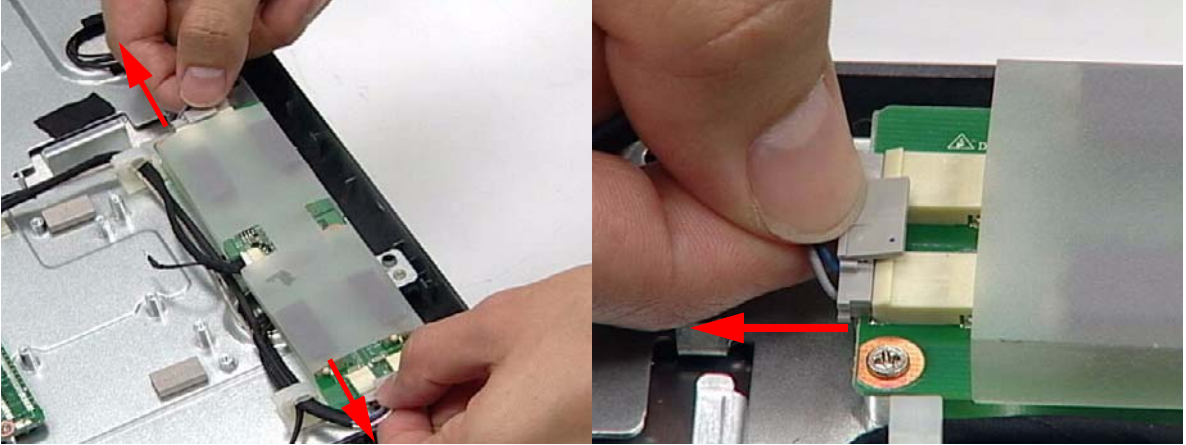

3. Disconnect the Mainboard Cable as shown.

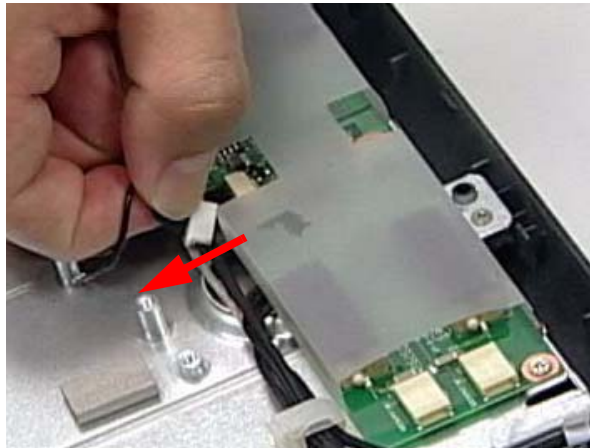

4. Remove three (3) securing screws from the Inverter Board.

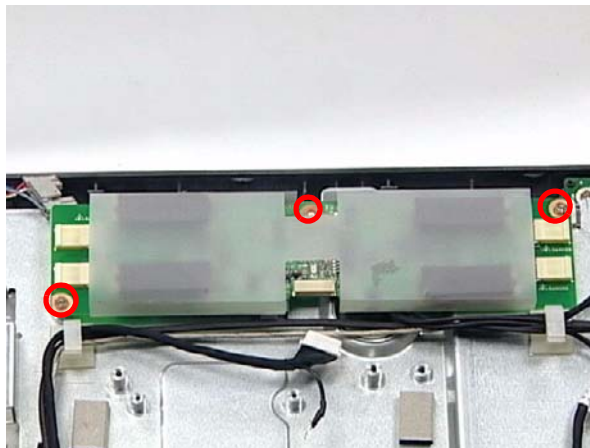

Step	Size	Quantity	Screw Type
Inverter Board		3	

5. Lift the Inverter Board clear of the device.

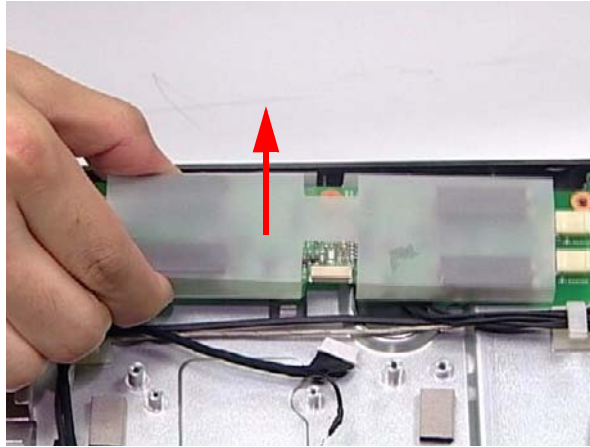

Removing the Home Button Board

1. See "Removing the Inverter Board" on page 53.
2. Remove one (1) securing screw from the Home Button Board.

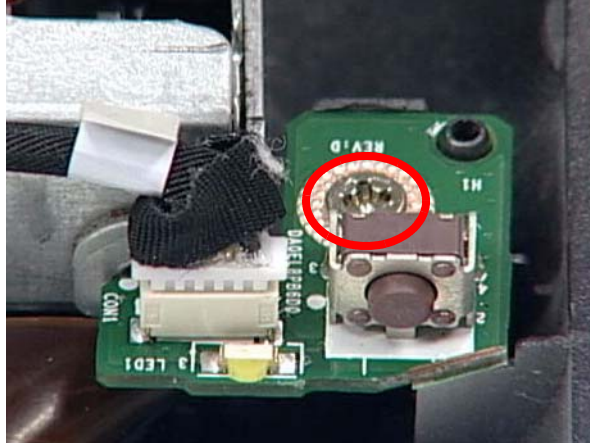

Step	Size	Quantity	Screw Type
Home Button Board		1	

3. Disconnect one (1) cable from the Home Button Board.

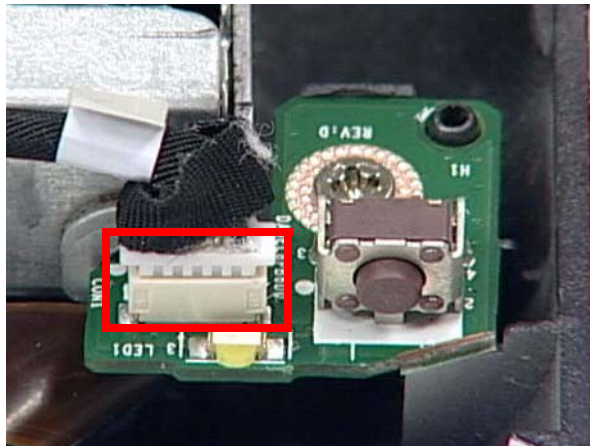

4. Lift the Home Button Board away as shown.

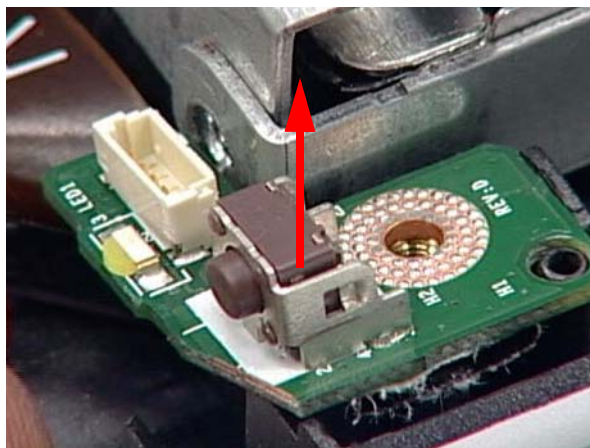

Removing the Web Camera Board

1. See "Removing the Home Button Board" on page 55.
2. Remove two (2) screws securing the Web Camera Board as shown.

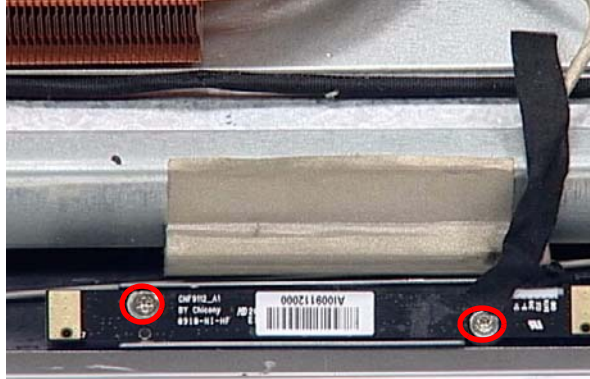

Step	Size	Quantity	Screw Type
Web Camera Board	SCREW M2.0*4	2	

3. Gently lift out the Web Camera Board and turn it over.

CAUTION: Do not use excessive force when removing the Web Camera Board.

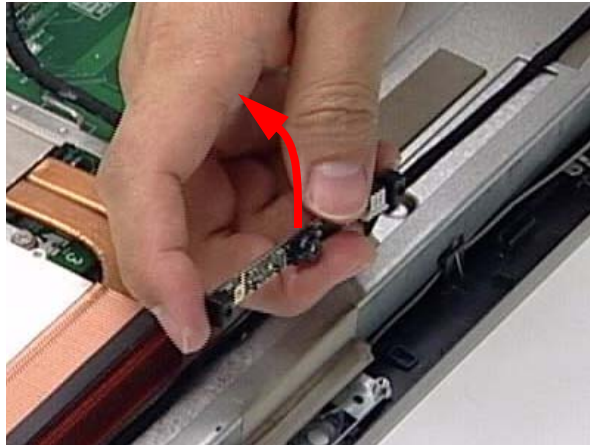

4. Disconnect the cable underneath.

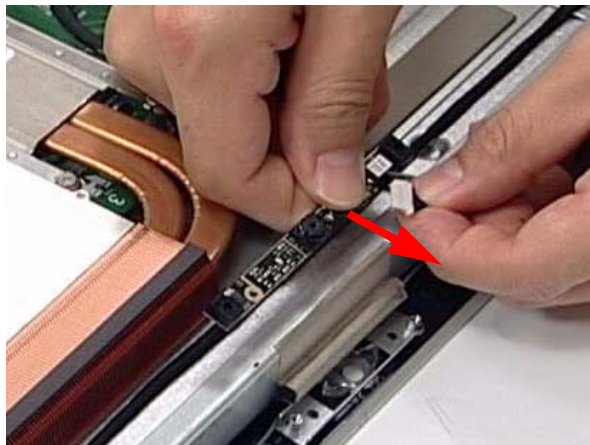

Removing the TV Tuner Board

1. See “Removing the Web Camera Board” on page 56.
2. Disconnect one (1) cable from the TV Tuner Board.



3. Remove one (1) securing screw from the TV Tuner Board.

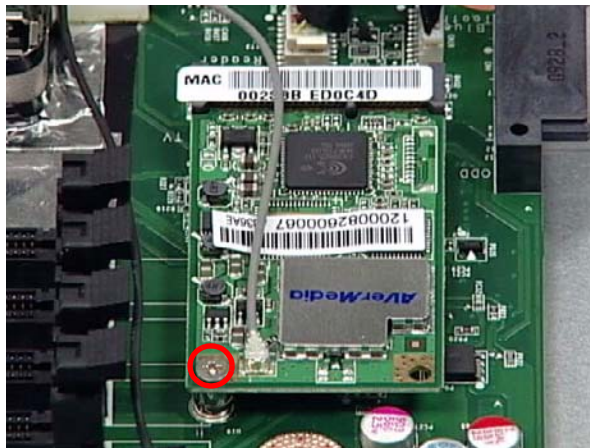

Step	Size	Quantity	Screw Type
TV Tuner Board		1	

4. Lift the TV Tuner Board away as shown.

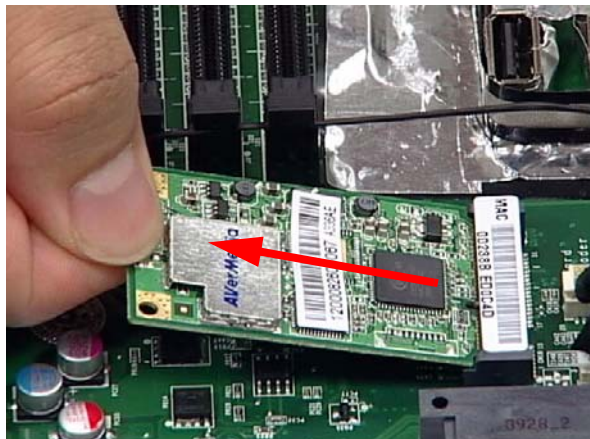

Removing the WLAN Board

1. See "Removing the TV Tuner Board" on page 57.
2. Disconnect two (2) cables from the WLAN Board as shown.

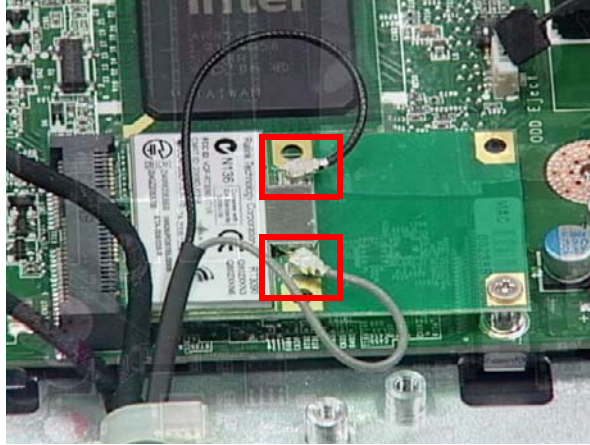

3. Remove one (1) securing screw from the WLAN Board.

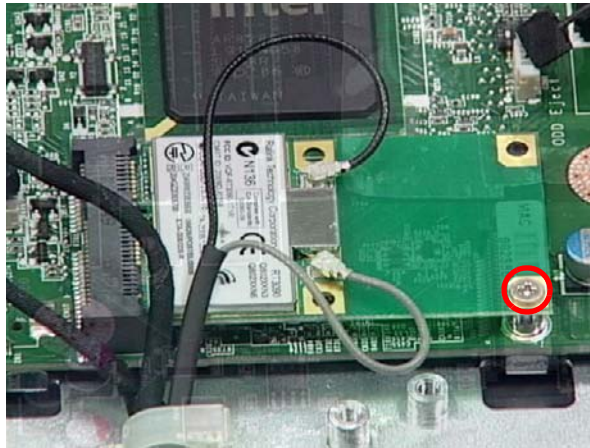

Step	Size	Quantity	Screw Type
WLAN Board		1	

4. Lift the WLAN Board clear of the device.

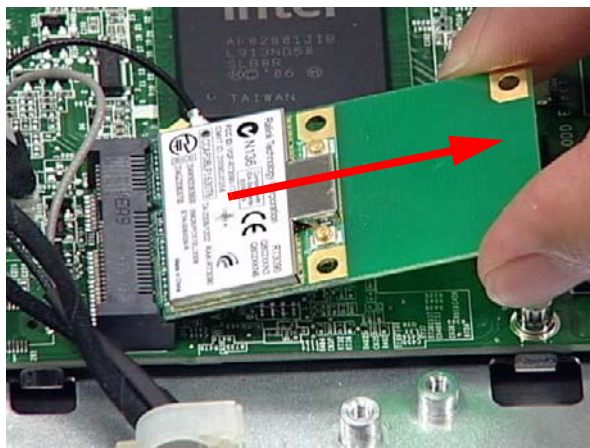

Removing the CPU Fan

1. See "Removing the WLAN Board" on page 58.
2. Disconnect the CPU fan cable from the Mainboard.

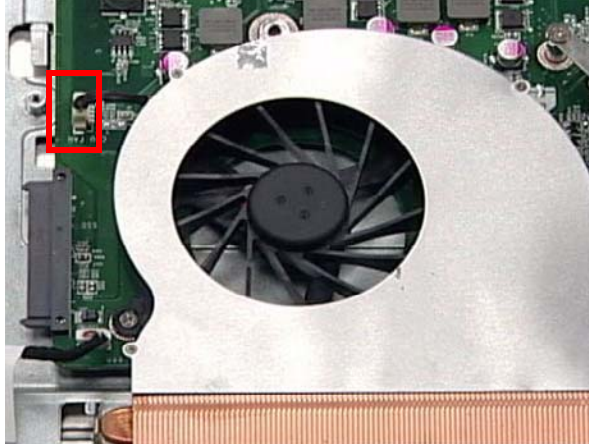

3. Remove two (2) securing screws from the Fan.

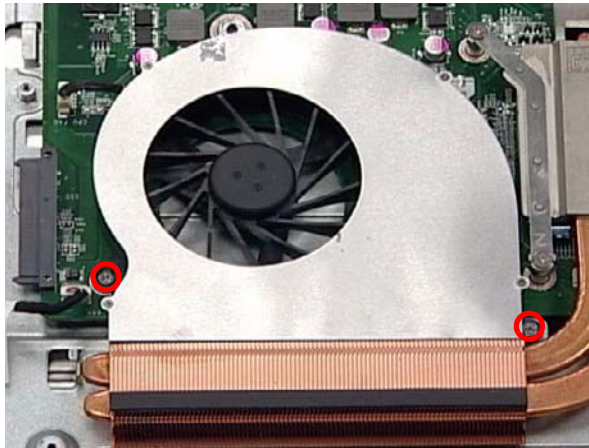

Step	Size	Quantity	Screw Type
CPU Fan	SCREW M2.5*6	2	

4. Lift the CPU Fan clear of the device.

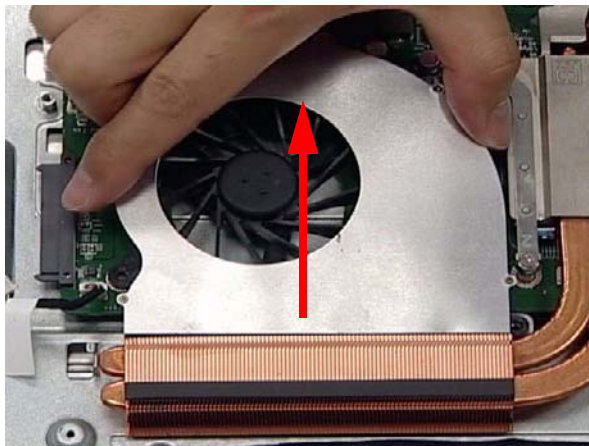

Removing the Thermal Module

1. See "Removing the CPU Fan" on page 59.
2. Remove six (6) captive screws from the Thermal Module in ascending order from 1 to 6.

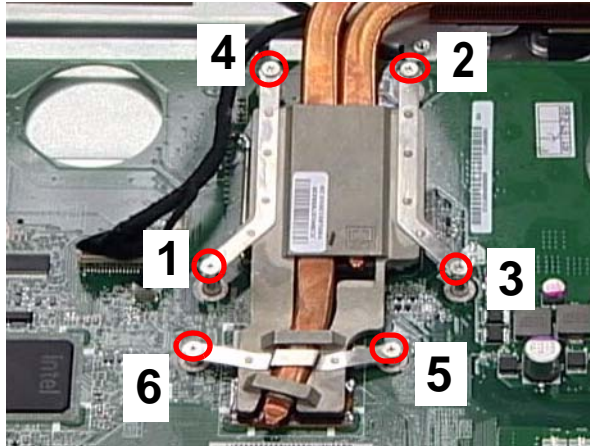

Step	Size	Quantity	Screw Type
Thermal Module		6	

3. Lift the Thermal Module clear of the device.

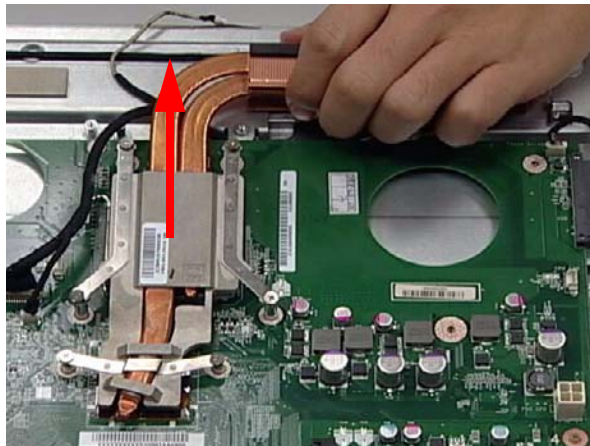

Removing the CPU

1. See “Removing the Thermal Module” on page 60.
2. Push the CPU latch down (1) and out (2) to unlock the processor housing.

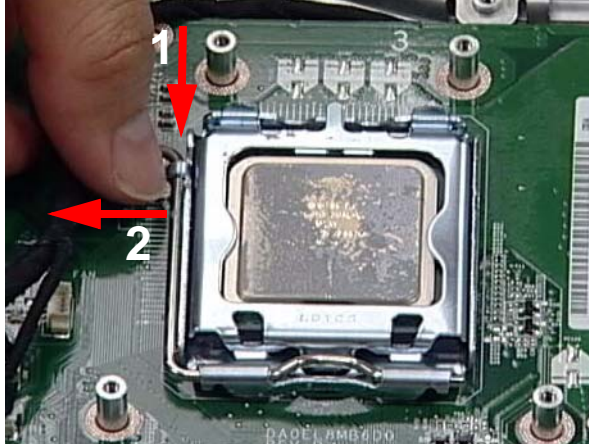

3. Lift the cover of the housing.

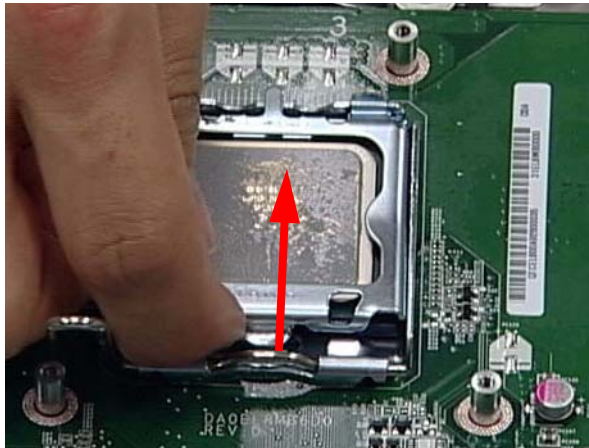

4. Remove the CPU.

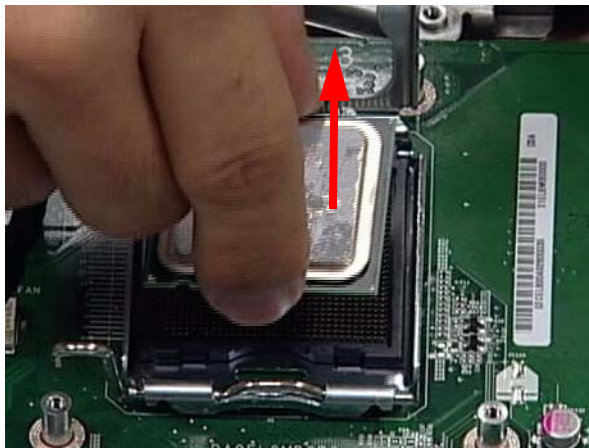

Removing the Mainboard Cables

1. See "Removing the CPU" on page 61.
2. Remove seventeen (17) cables from the Mainboard as shown.

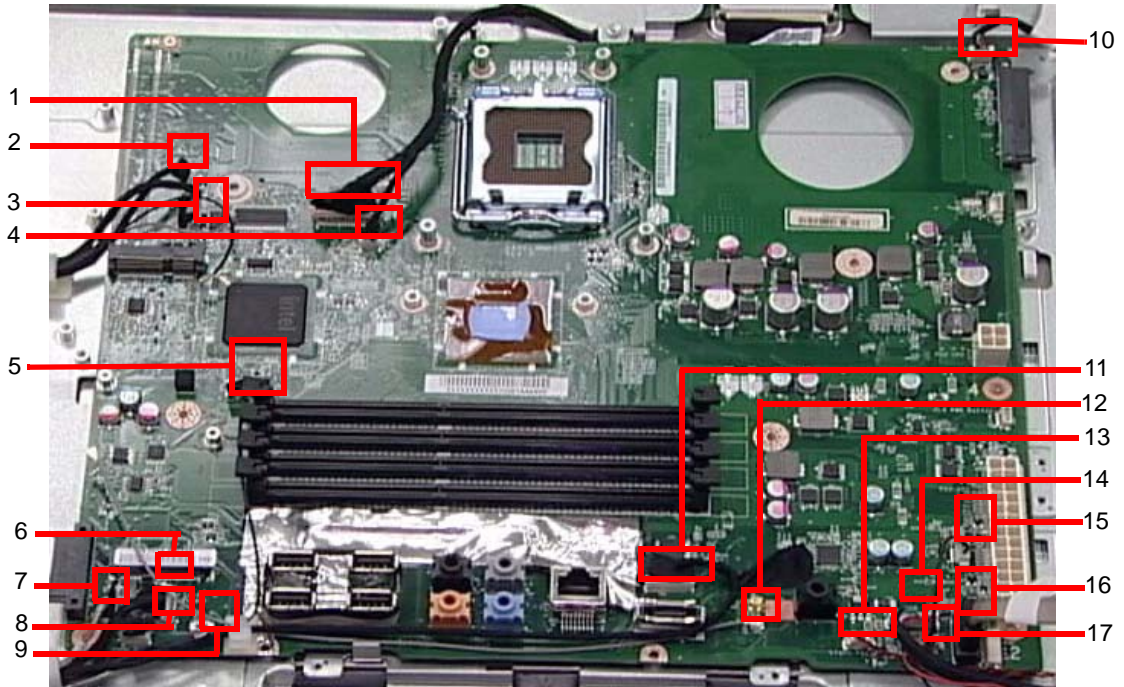

Item	Description
1	LVDS Cable
2	CCD Cable
3	Inverter Cable
4	MIC Cable
5	ODD Button Cable
6	
7	Home Button Cable
8	Card Reader Cable
9	IR Cable
10	Touch Screen
11	Audio Cable
12	TV Tuner Cable
13	
14	USB Cable
15	Speaker Cable
16	SATA Cable
17	LED Light

Removing the Mainboard

1. See "Removing the Mainboard Cables" on page 62.
2. Remove five (5) securing screws from the Mainboard as shown.

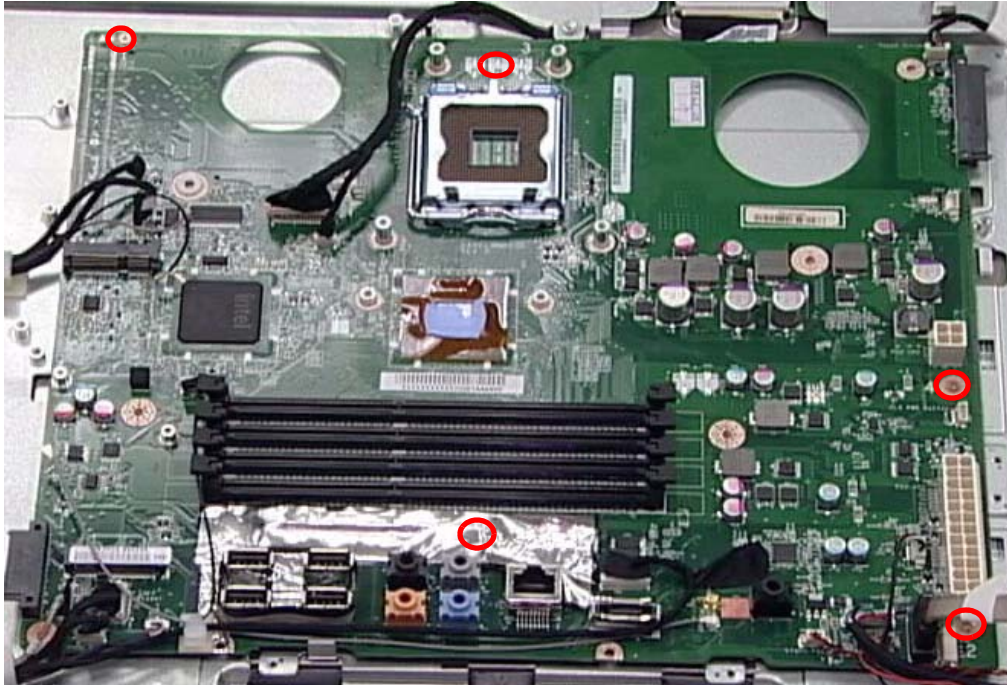

Step	Size	Quantity	Screw Type
Mainboard	SCREW M 2.5*4MM	5	

3. Carefully lift the Mainboard clear of the device.

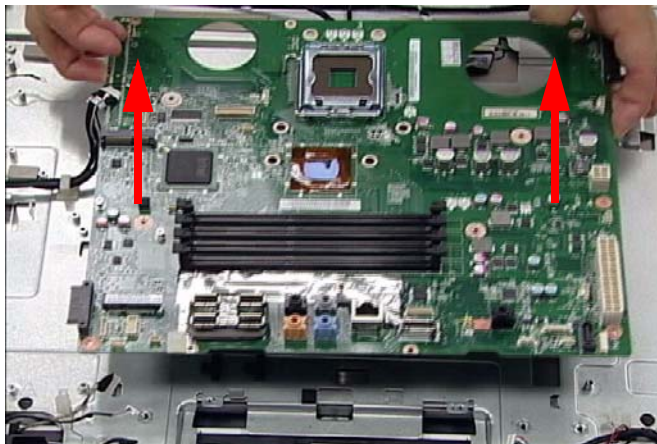

Removing the LCD Assembly

1. See "Removing the Mainboard" on page 63.
2. Release five (5) cable locks as shown.

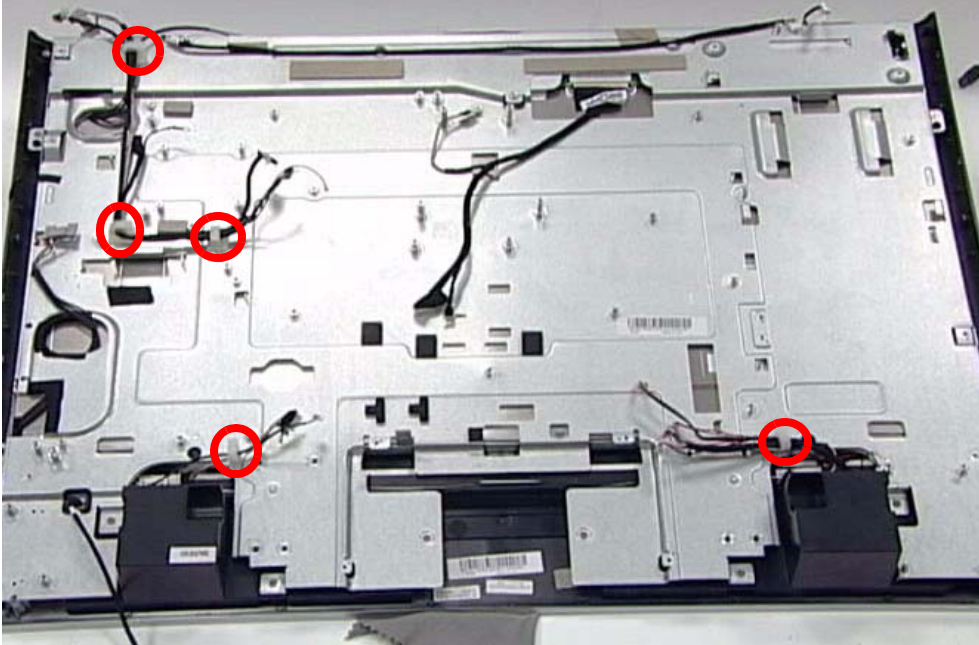

3. Disconnect the Home Button Cable.

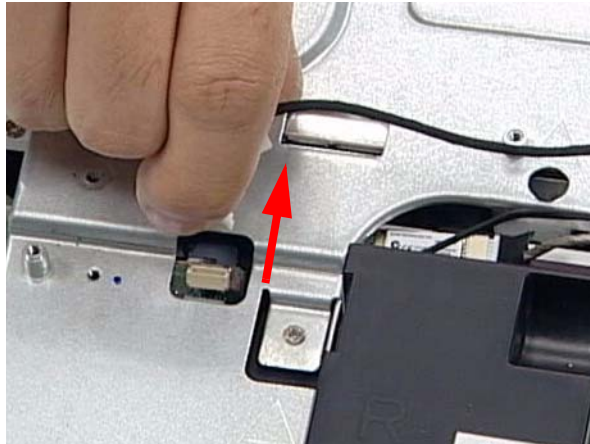

4. Remove the LVDS Mylar (1) and disconnect the cable (2) as shown.

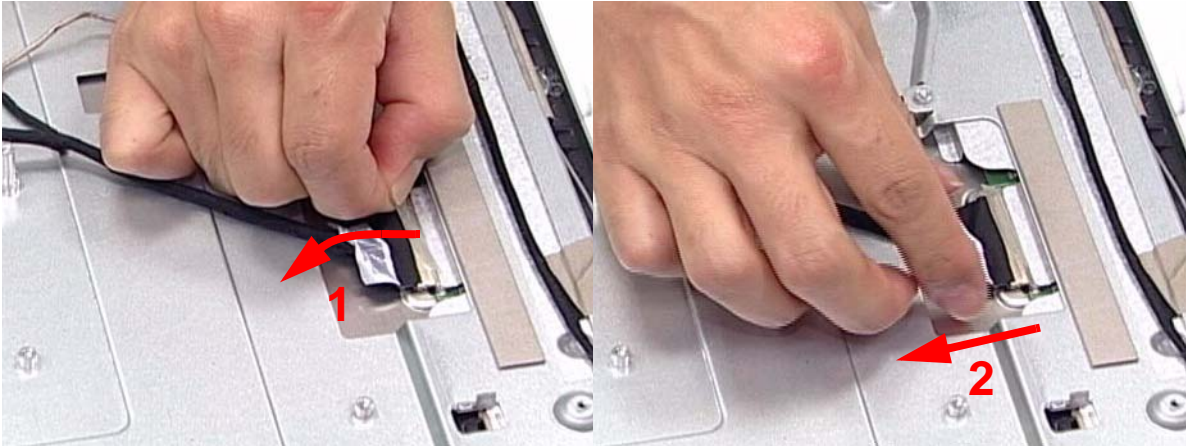

5. Disconnect the left and right Control board Cables.

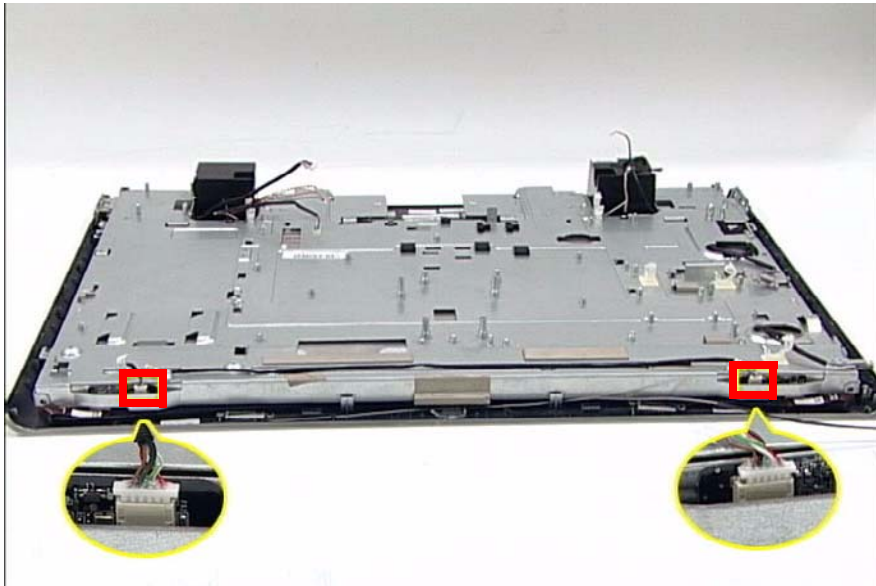

6. Remove four (4) securing screws from the LCD Bracket.

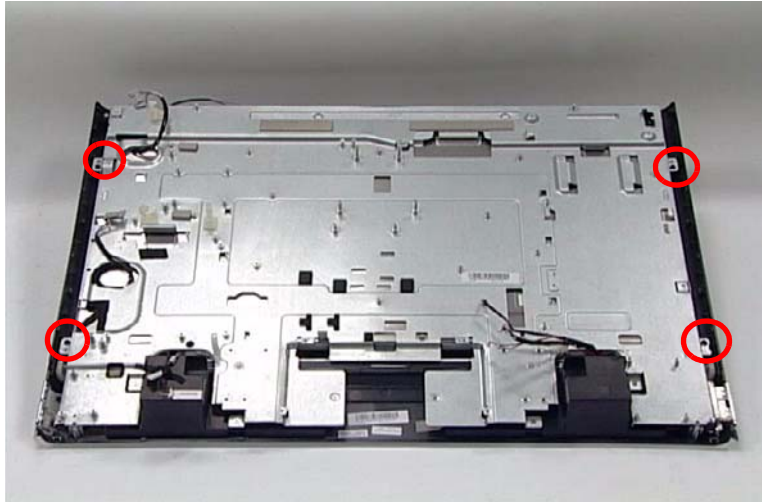

Step	Size	Quantity	Screw Type
LCD Bracket	SCREW M2.5*4	4	

7. Remove nine (9) securing screws from the LCD Bezel.

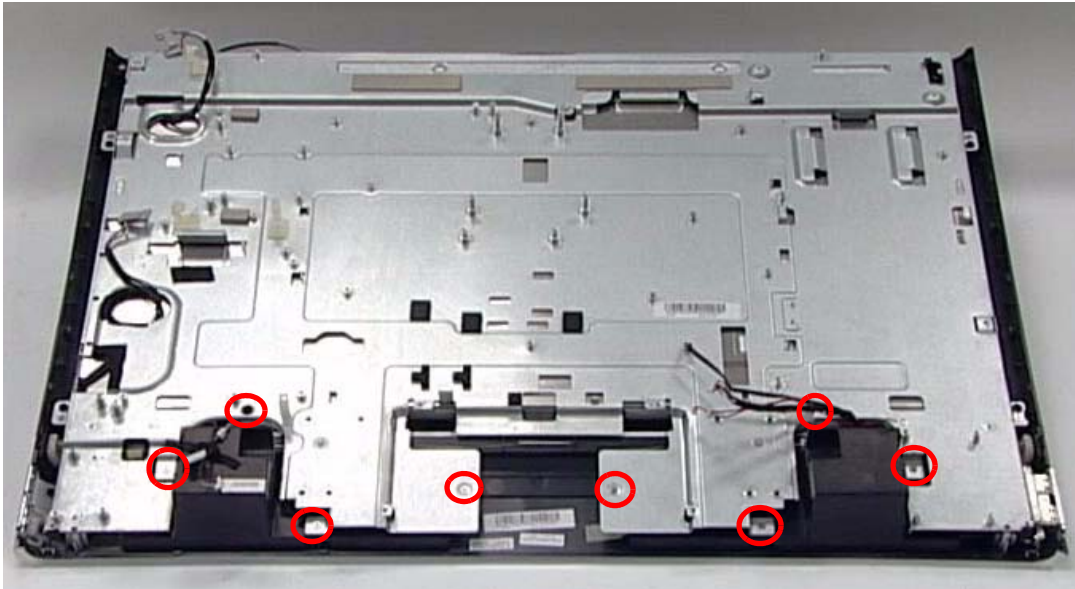

Step	Size	Quantity	Screw Type
LCD Bezel	SCREW M2.5*4	9	

8. Lift the LCD Assembly clear of the device.

WARNING:When lifting the LCD Assembly, do not touch the Camera Modules located at the top left and top right corners of the device. Doing so will damage the touch screen function.

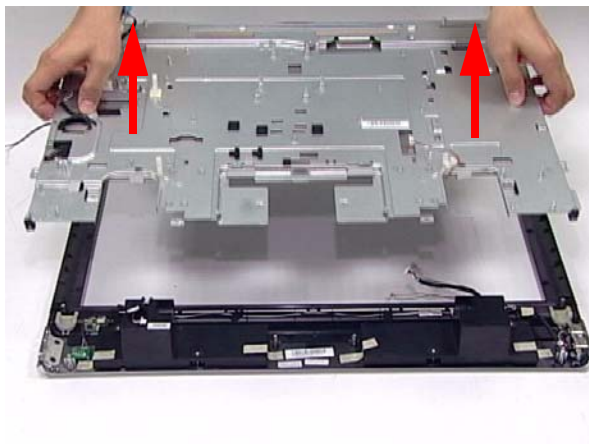

Removing the LCD Bracket

1. See "Removing the LCD Assembly" on page 64.
2. Place the LCD Assembly on an anti-static mat so the touch sensors are elevated above the work surface.
WARNING: Do not place the LCD Panel face down without an anti-static mat underneath. The touch sensors located at the top left and top right corners will be damaged if the LCD Panel is placed face down.
3. Remove four (4) securing screws from the LCD Panel as shown.

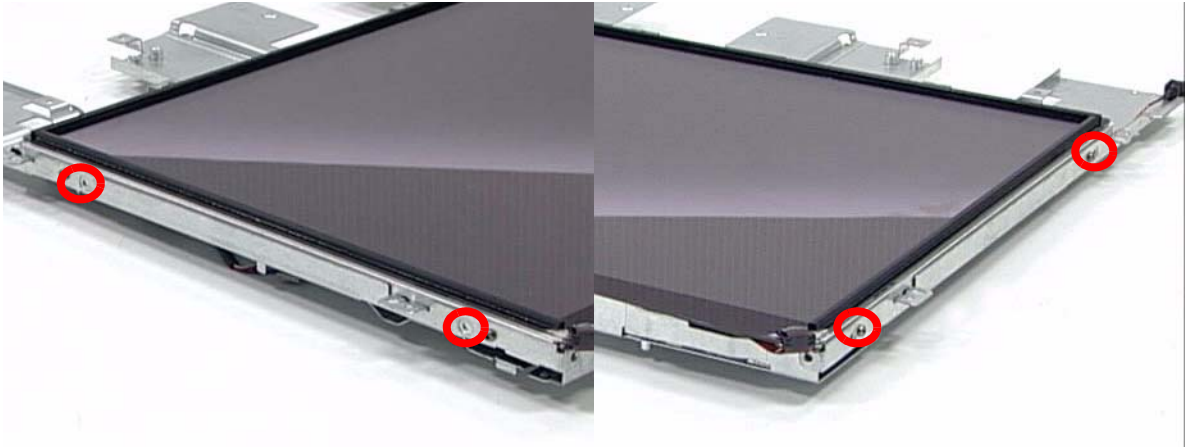

Step	Size	Quantity	Screw Type
LCD Bracket		4	

4. Separate the LCD Bracket from the LCD Panel, while guiding the cables through the frame.

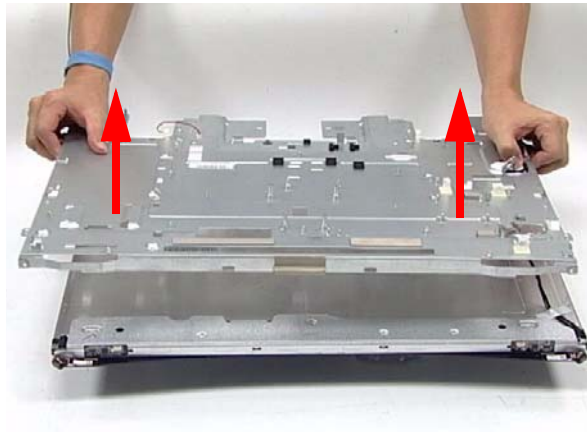

Reassembly Procedure

Replacing the LCD Bracket

1. Replace one side of the LCD Bracket (1), while using the opposite hand to pull the cables through the frame (2). Make sure the frame is fitted securely on top of the panel.

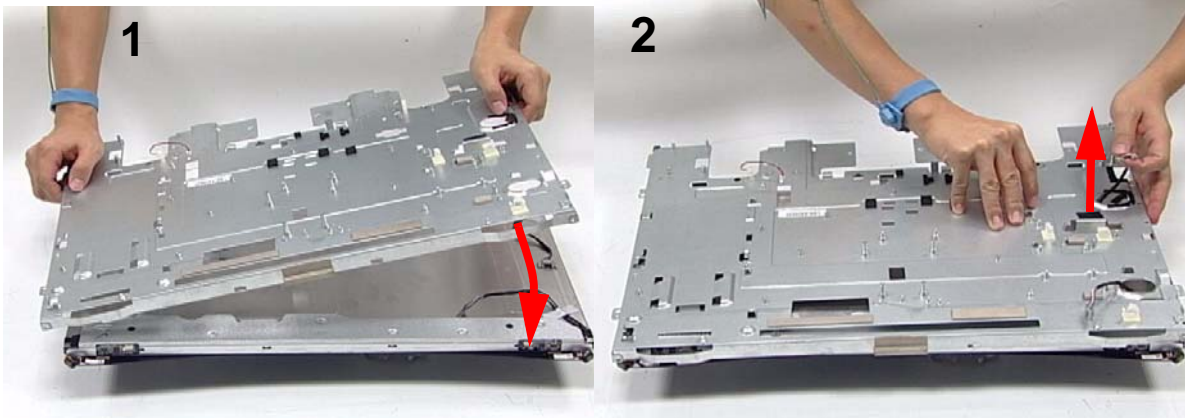

2. Secure the LCD Panel to the frame using four (4) screws.



Replacing the LCD Assembly

1. Carefully place the LCD Assembly in the LCD Bezel.

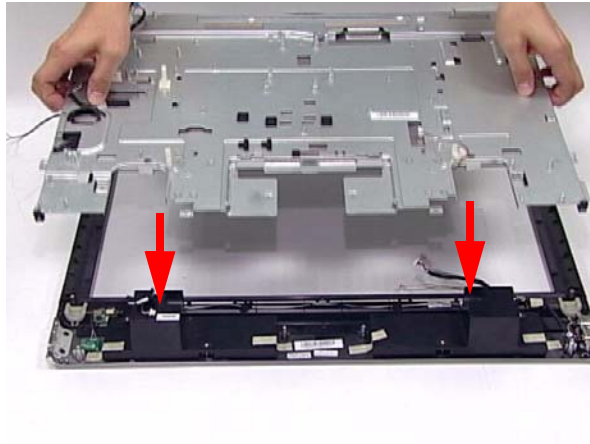

2. Secure the LCD Bezel using nine (9) screws.

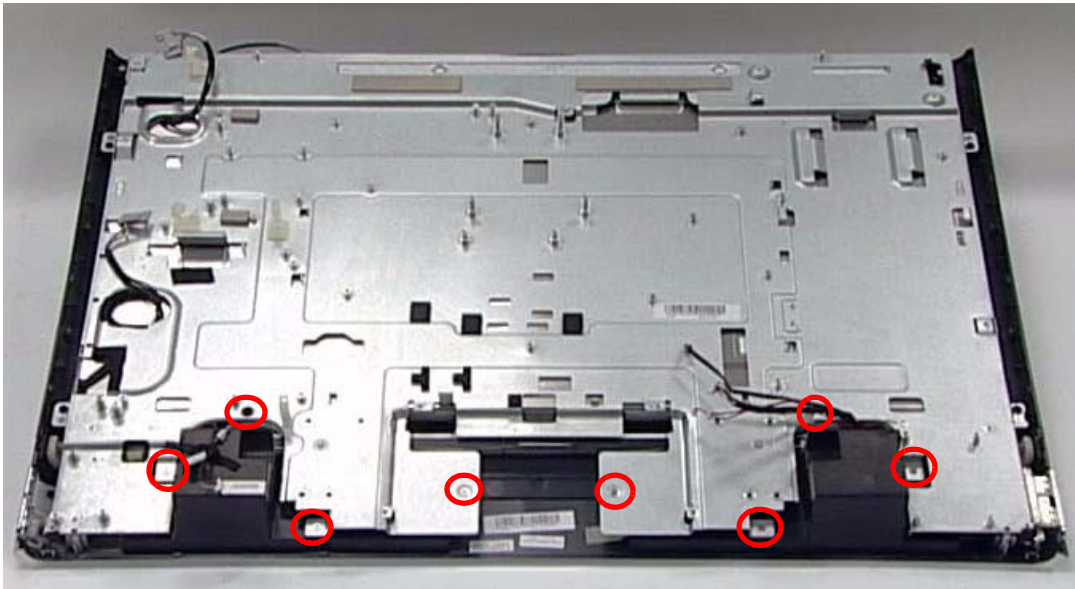

3. Secure the LCD Bracket using four (4) screws.

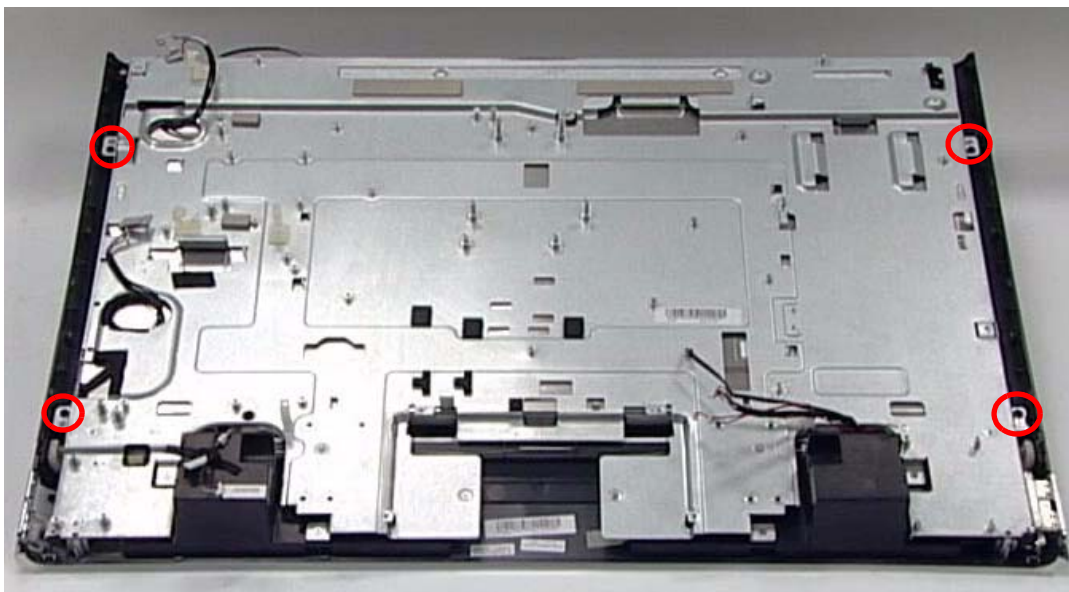

4. Connect the left and right Control Board Cables.

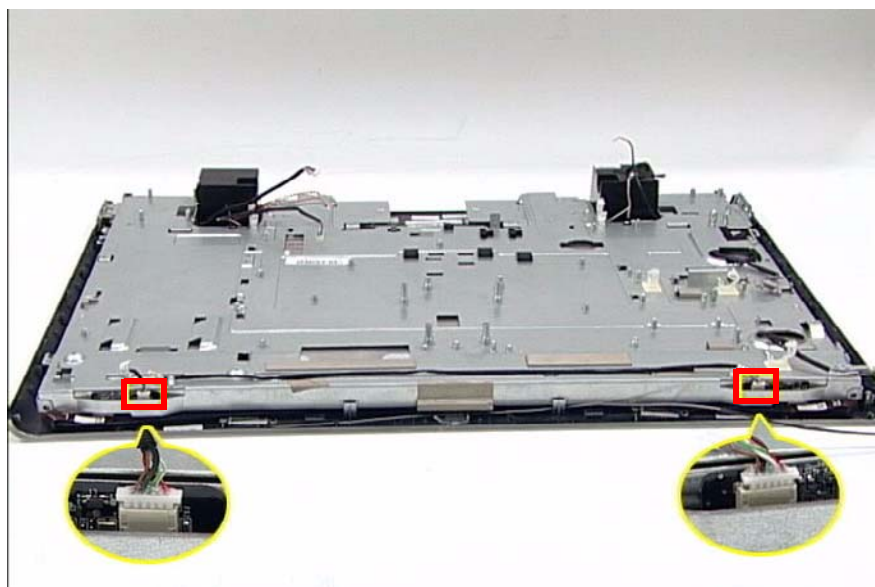

5. Replace the LVDS Mylar (1) and connect the cable (2).

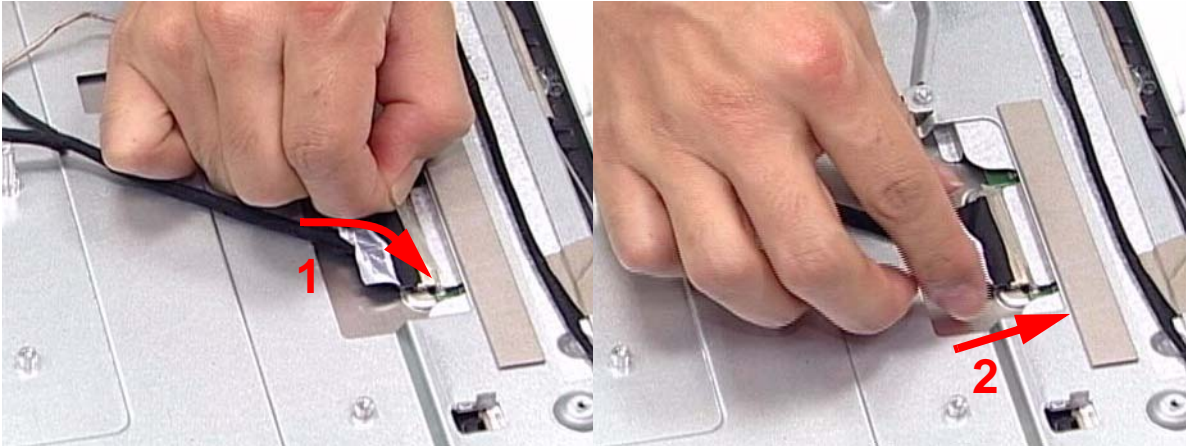

6. Connect the Home Button Cable

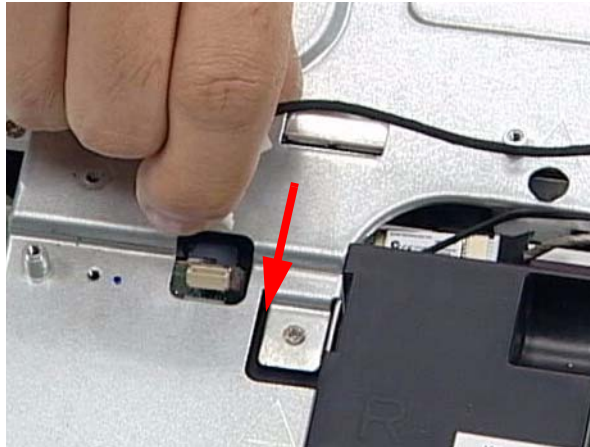

7. Lock the five (5) cable locks as shown.

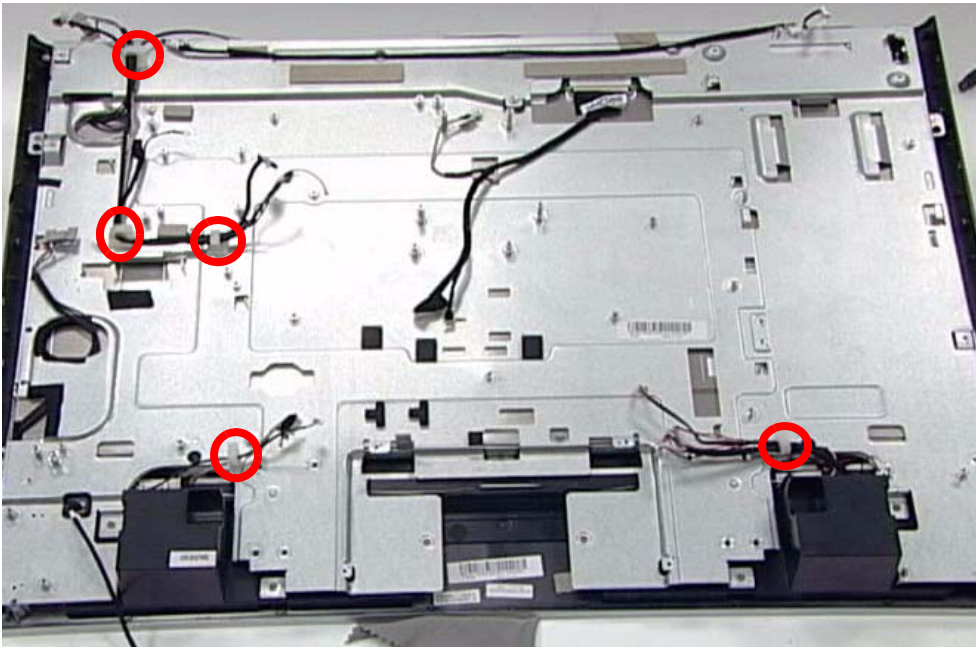

Replacing the Mainboard

1. Carefully replace the Mainboard, while lining up the six (6) guide pins underneath.

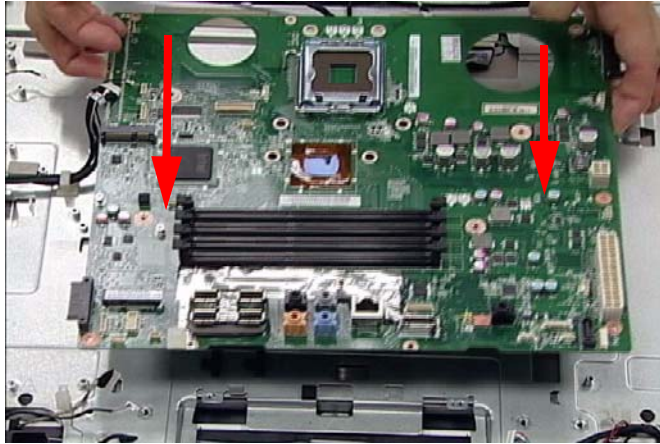

2. Secure the Mainboard in place using five (5) screws as shown.

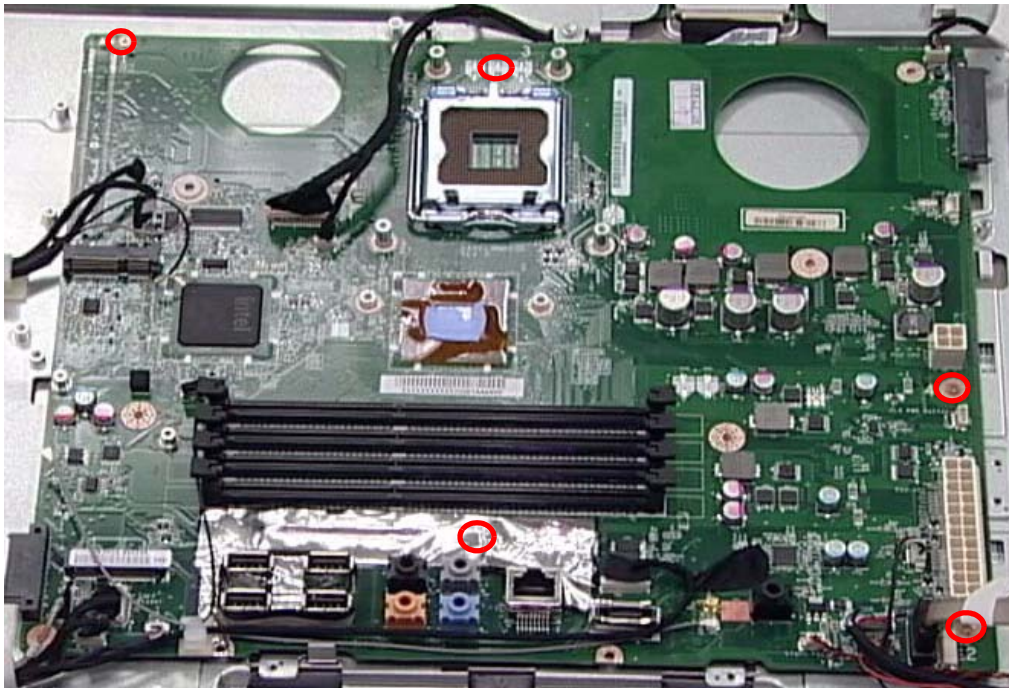

Replacing the Mainboard Cables

1. Secure the Mainboard by connecting seventeen (17) cables.

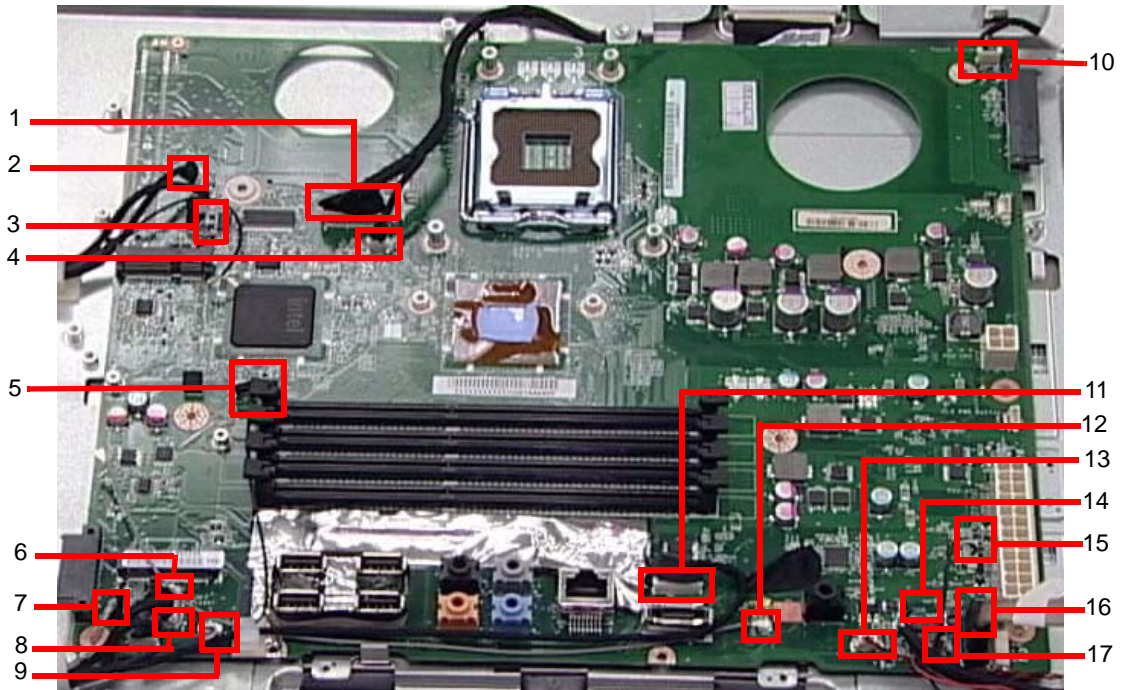

Item	Description
1	LVDS Cable
2	CCD Cable
3	Inverter Cable
4	MIC Cable
5	ODD Button Cable
6	
7	Home Button Cable
8	Card Reader Cable
9	IR Cable
10	Touch Screen
11	Audio Cable
12	TV Tuner Cable
13	
14	USB Cable
15	Speaker Cable
16	SATA Cable
17	LED Light

Replacing the CPU

1. Place the CPU in the CPU housing.

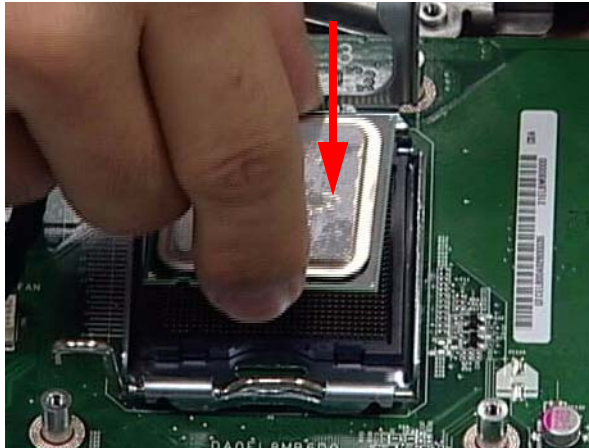

2. Close the cover of the housing.

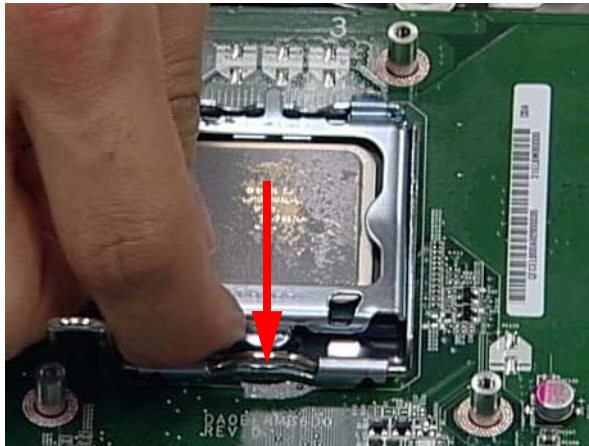

3. Push the CPU latch down (1) and in (2) to lock the processor housing.

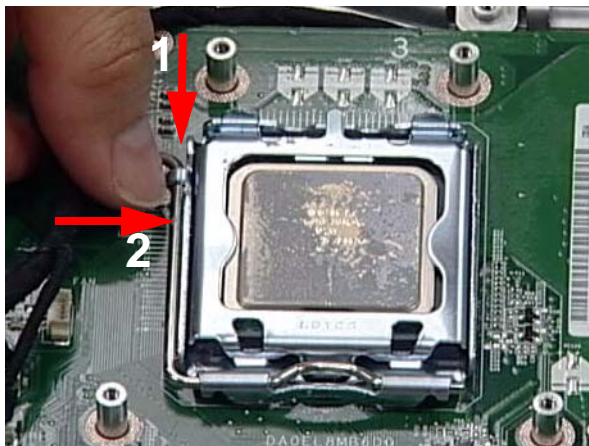

Replacing the Thermal Module

IMPORTANT: Ensure a heat pad is in place before replacing the Thermal Module.

1. Replace the Thermal Module as shown.

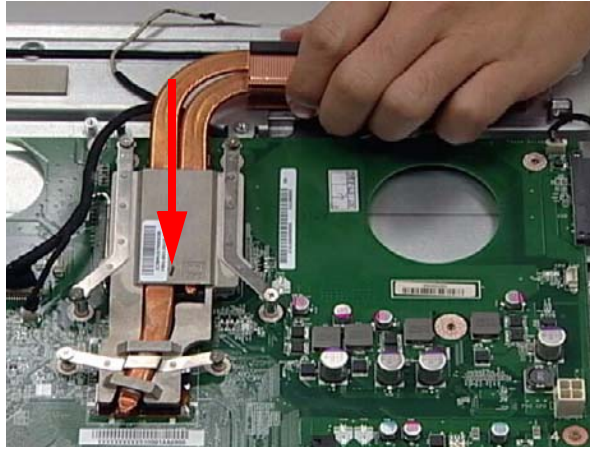

2. Secure the module by tightening six (6) captive screws in ascending order from 1 to 6.

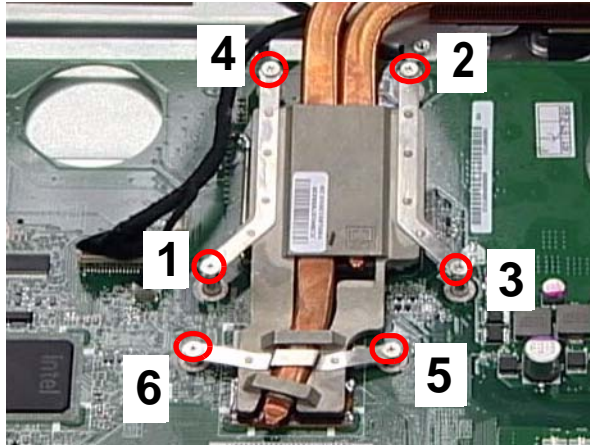

Replacing the CPU Fan

1. Using both hands, align the screw holes on the fan and LCD Module and place the fan on the Thermal Module.

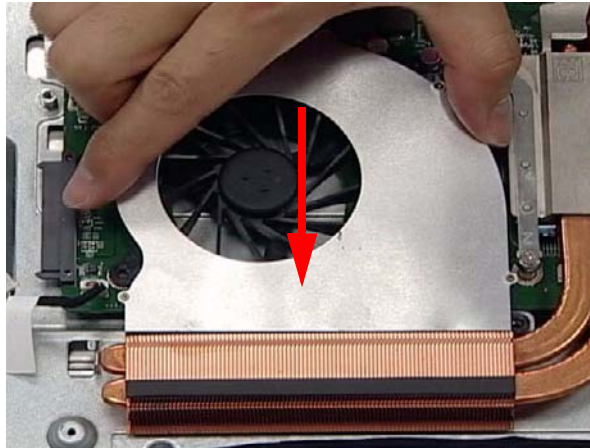

2. Connect the CPU Fan cable to the Mainboard connector.

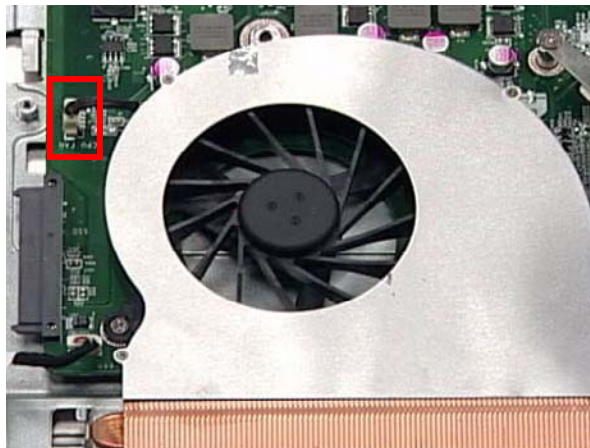

3. Secure the Fan using two (2) screws as shown.

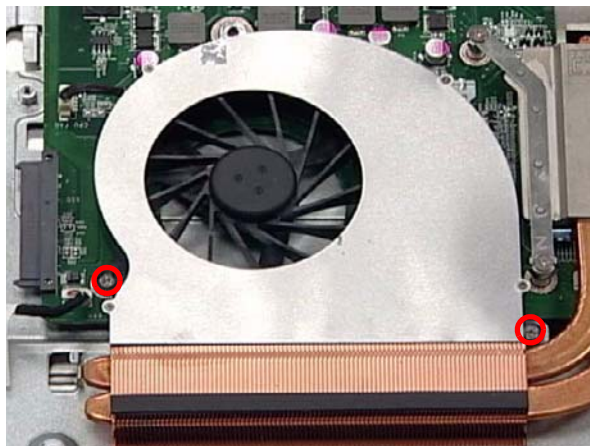

Replacing the WLAN Board

1. Push the WLAN Board into the slot.

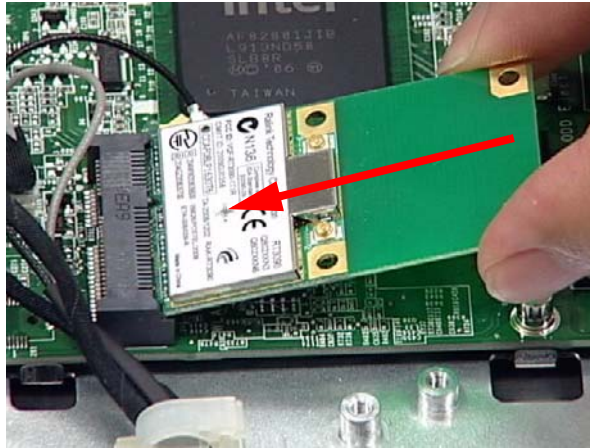

2. Secure the WLAN Board using one (1) screw as shown.

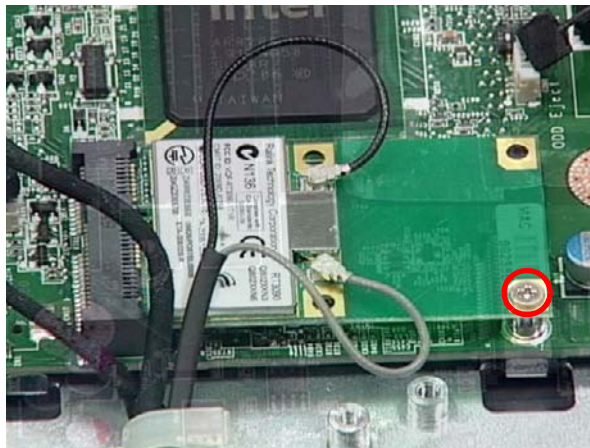

3. Connect two (2) cables to secure the WLAN Board.

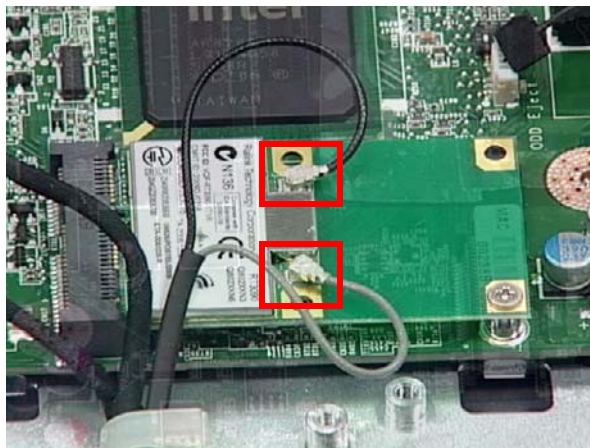

NOTE: The gray and black cables must be attached to the proper connector to function properly.

Replacing the TV Tuner Board

1. Push the TV Tuner Board into the slot.

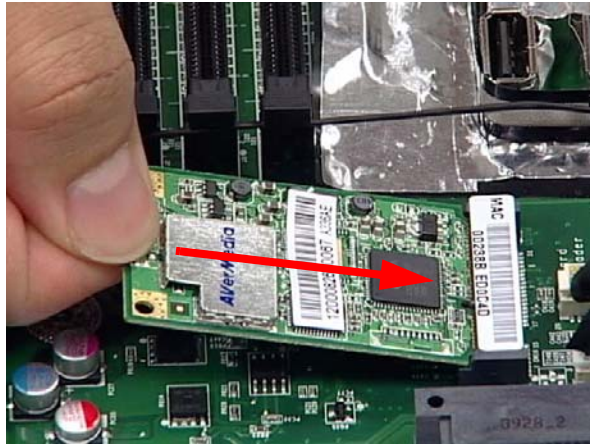

2. Secure the TV Tuner Board using one (1) screw as shown.

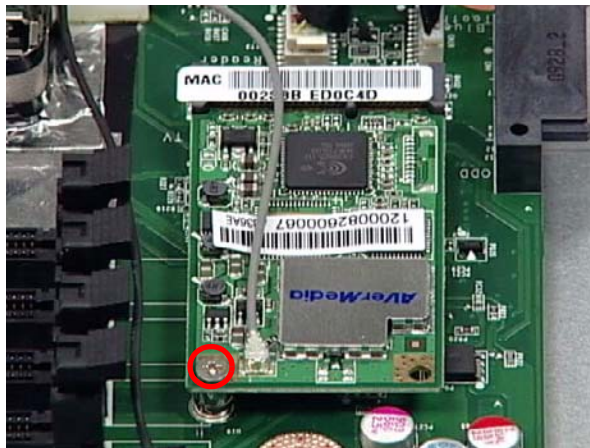

3. Connect one (1) cable to secure the TV Tuner Board.



Replacing the Web Camera Board

1. Connect the cable underneath the Web Camera board.

CAUTION: Do not use excessive force when handling the Web Camera Board.

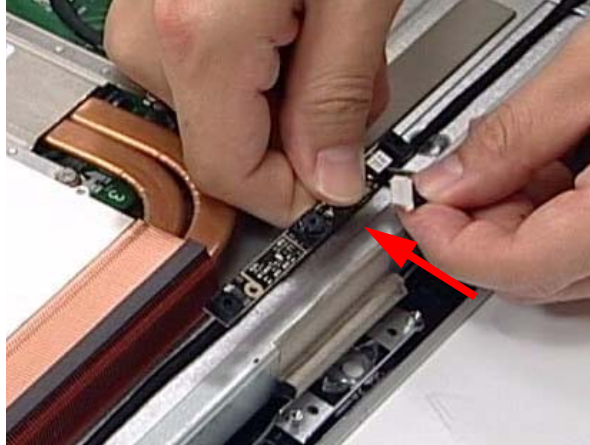

2. Turn the Board over and place it in the device.

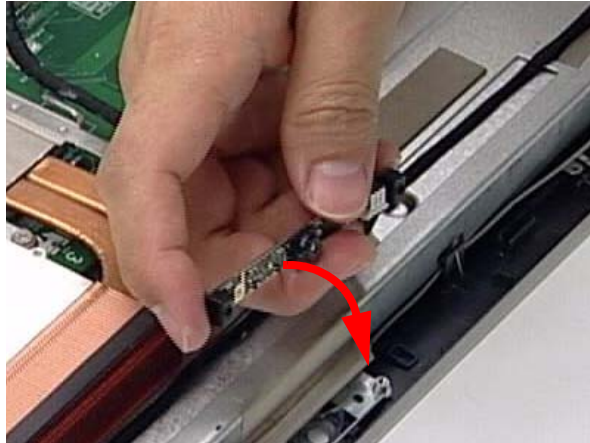

3. Secure the Web Camera Board using two (2) screws as shown.

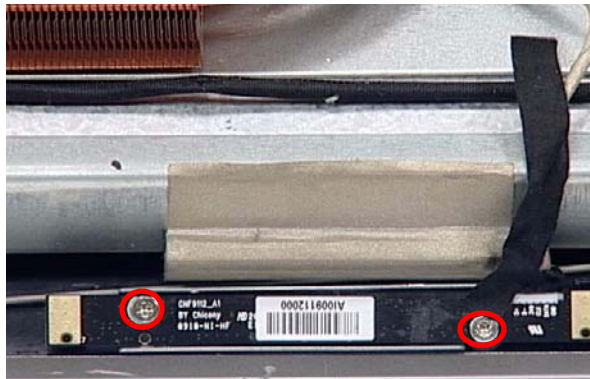

Replacing the Home Button Board

1. Replace the Home Button Board, while lining up the guide pin underneath.

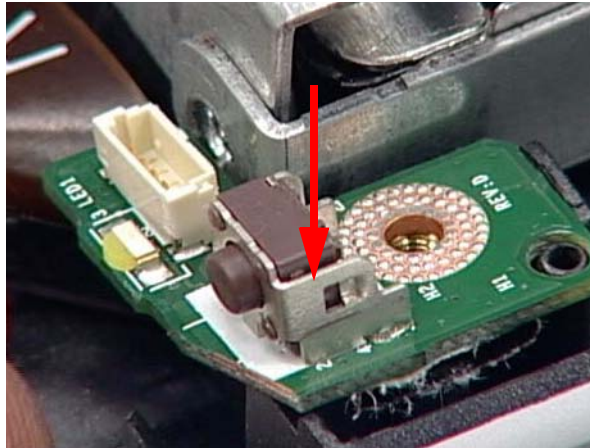

2. Secure the Home Button Board using one screw.

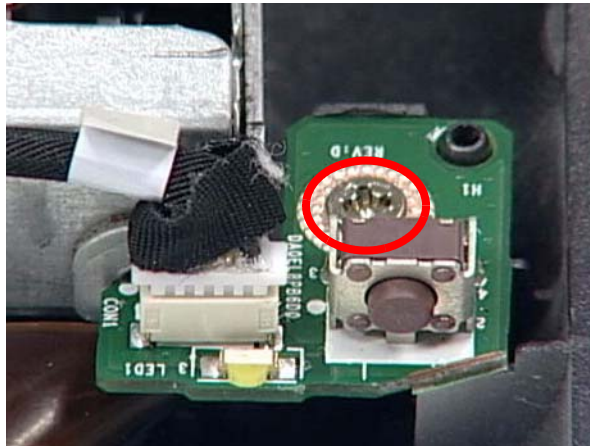

3. Connect one cable to secure the Home Button Board.

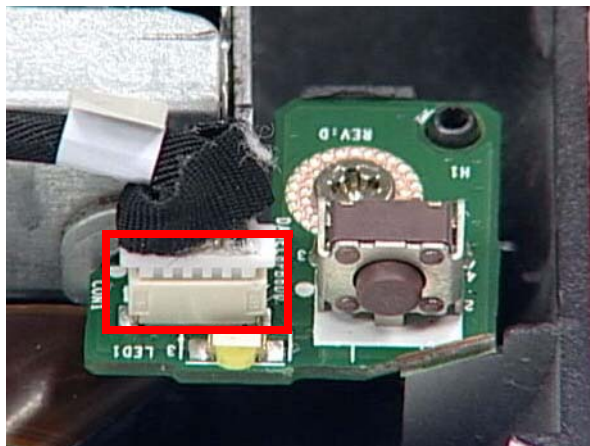

Replacing the Inverter Board

1. Replace the Inverter Board as shown.

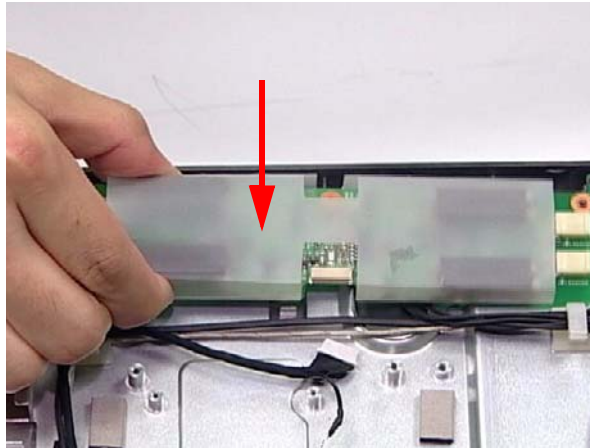

2. Secure the Inverter Board using three (3) screws.

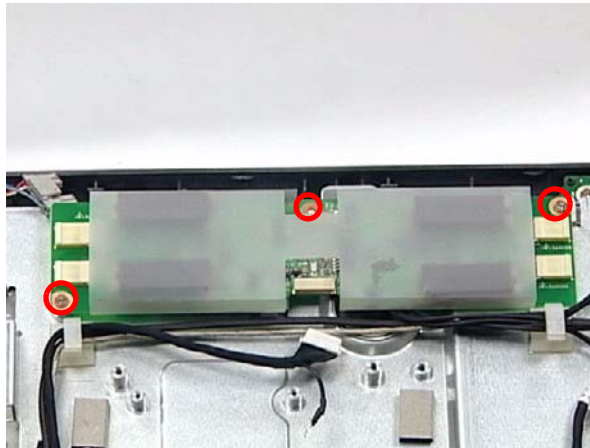

3. Connect the Mainboard cable to the Inverter Board as shown.

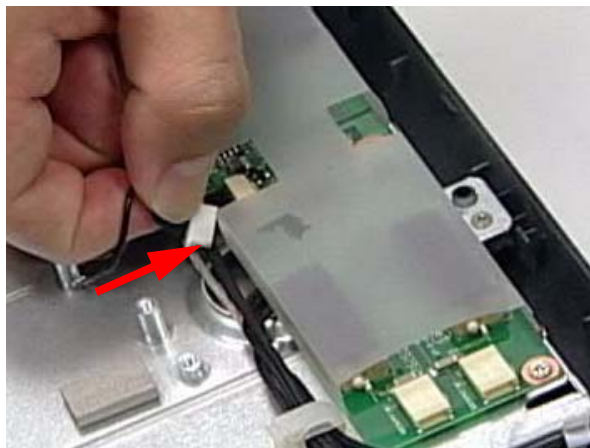

4. Connect the cables on either side of the Inverter Board.

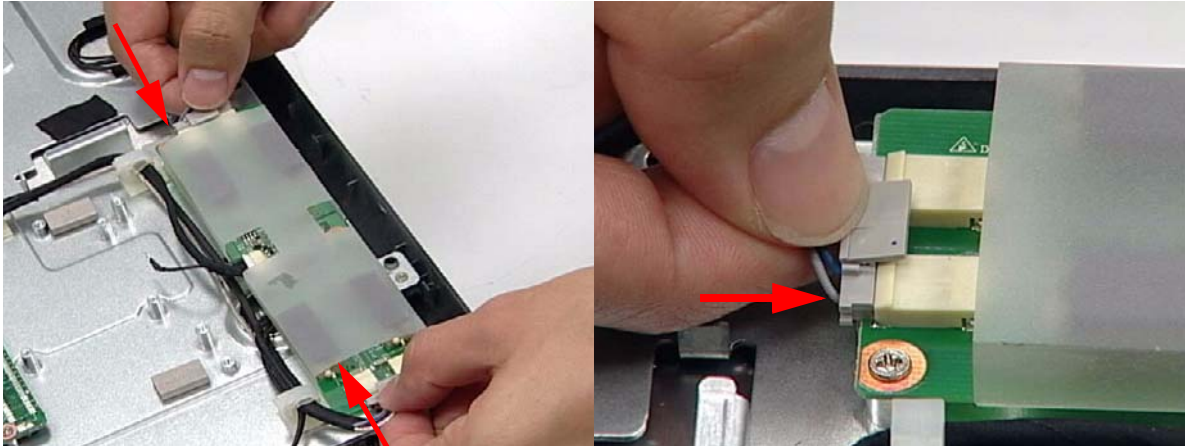

Replacing the ODD Module

1. Slide the ODD Module into the flange.

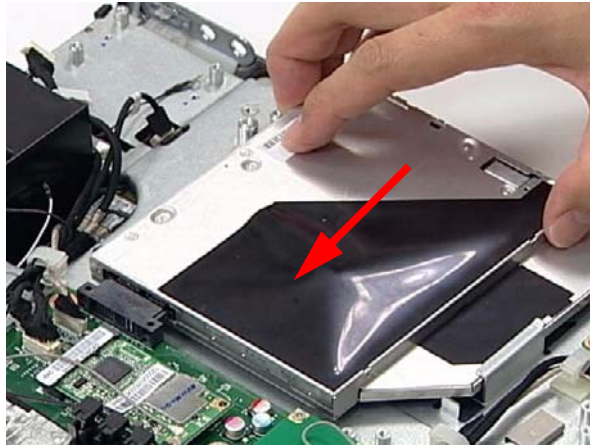

2. Secure the ODD Module using two (2) screws.



Replacing the ODD Button Board

1. Replace the ODD Button Board while lining up the guide pin underneath.



2. Secure the ODD Button Board using one (1) screw.



3. Connect one (1) cable to secure the ODD Button Board as shown.



Replacing the Audio Board

1. Replace the Audio Board by lining up the ports with the bracket and three (3) guide pins as shown.

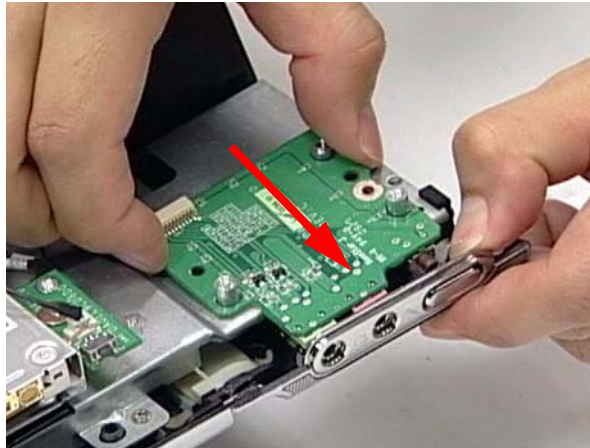

2. Secure the Audio Board using one (1) screw.

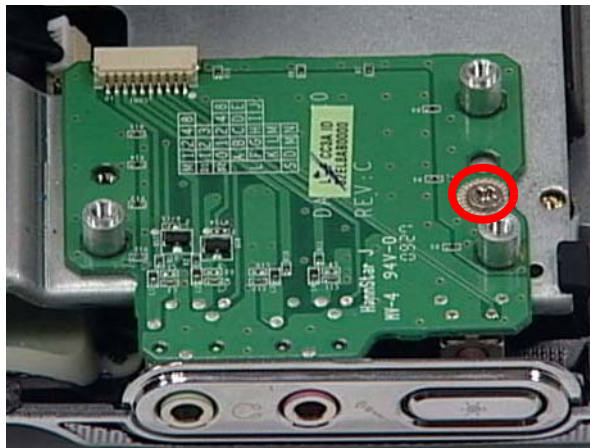

3. Connect the Audio Board Cable.

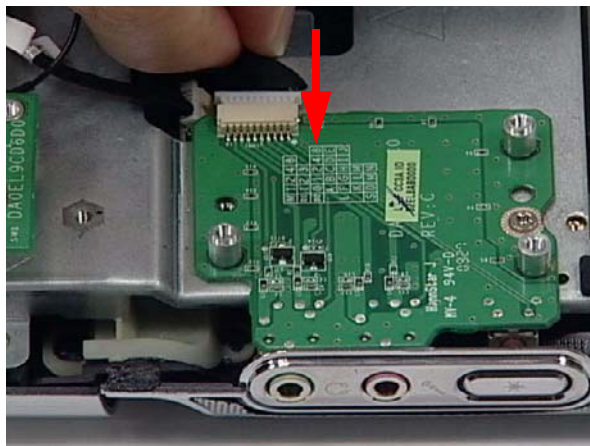

Replacing the Card Reader Board

1. Replace the Card Reader Board.

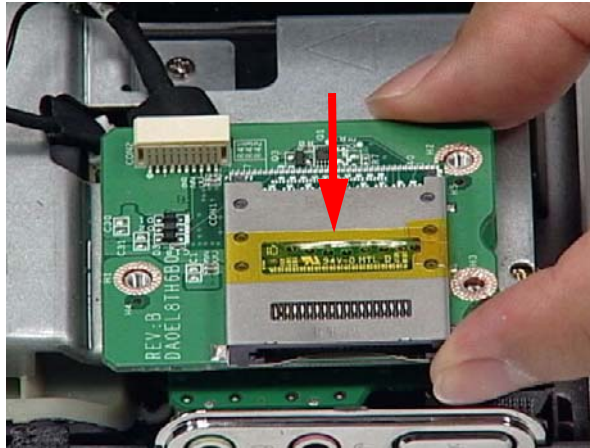

2. Secure the Card Reader Board using three (3) screws.

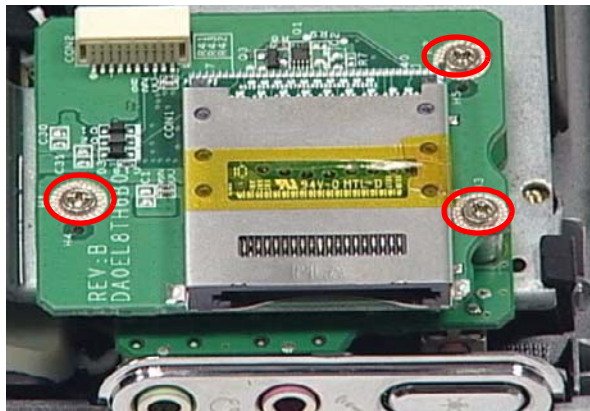

3. Connect the Card Reader Board Cable.

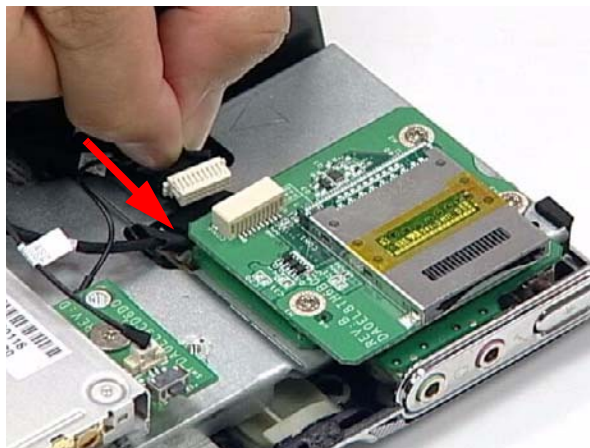

Replacing the Control Board

1. Replace the Control Board.

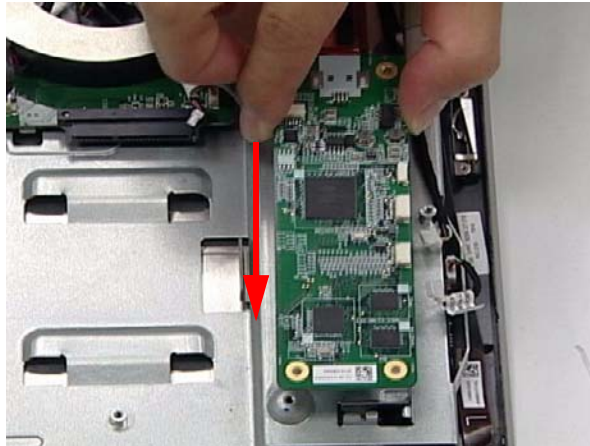

2. Secure the Control Board using two (2) screws.

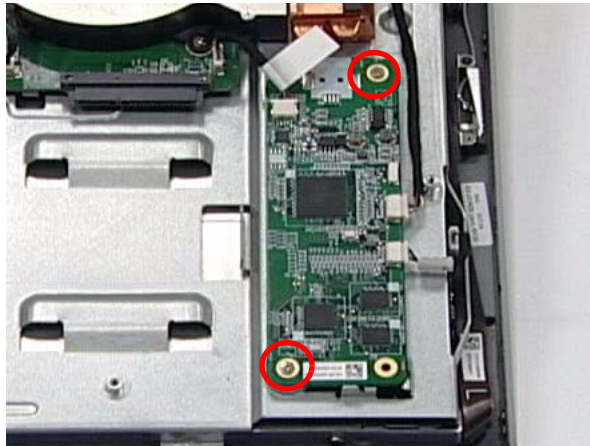

3. Connect three (3) cables to secure the Control Board as shown.

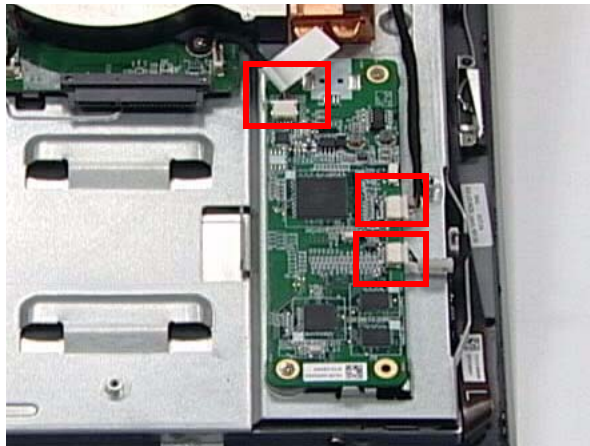

Replacing the SSD

1. Slide the SSD into the flange.



2. Secure the SSD using one (1) screw as shown.



Replacing the B-CAS Board

1. Connect the cable underneath the B-CAS Board.

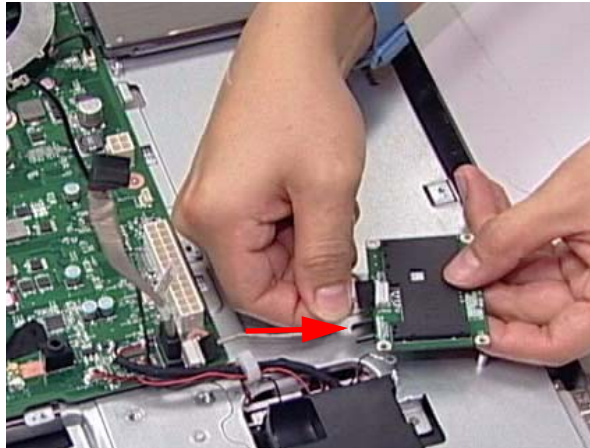

2. Turn the B-CAS Board over and replace it.

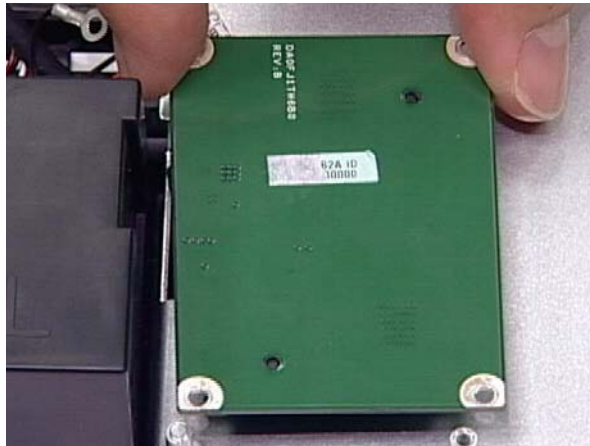

3. Install the USB and HDD grounding cables as shown.

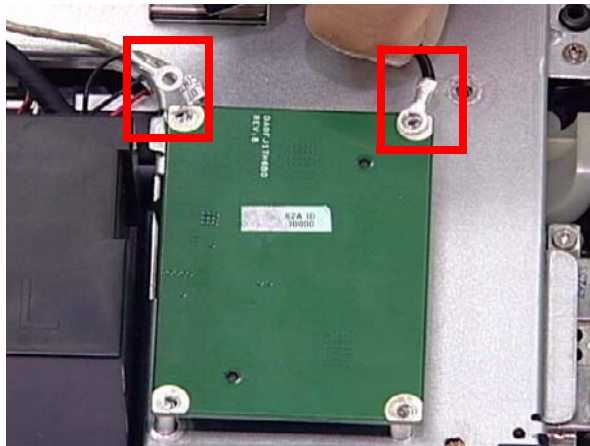

4. Secure the B-CAS Board with three (3) screws.

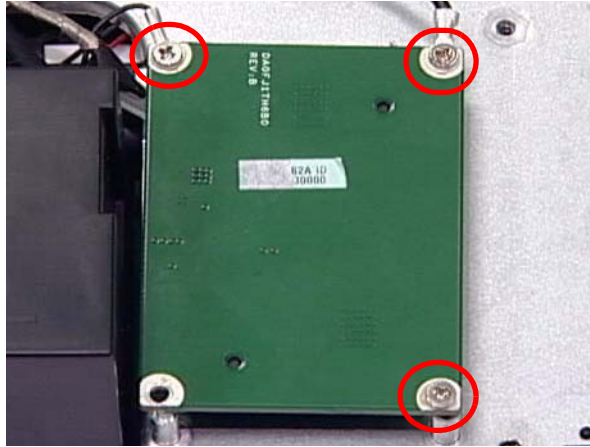

Replacing the HDD Module

1. Slide the HDD Module into the flanges.

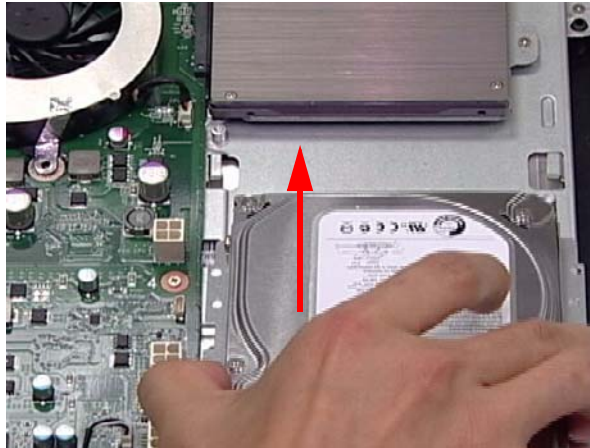

2. Secure the HDD Module using two (2) screws.



3. Connect the HDD Cable as shown.

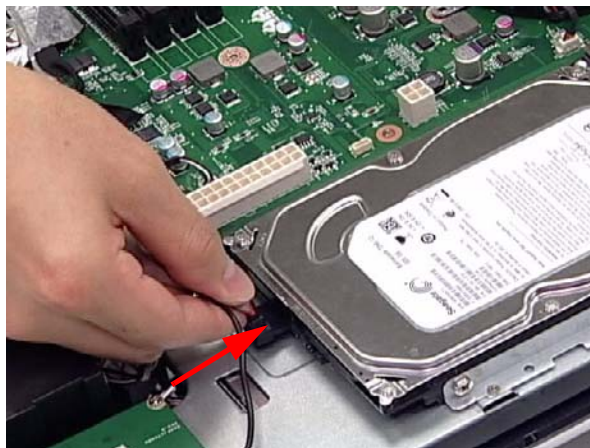

Replacing the Power Supply

1. Replace the Power Supply as shown.

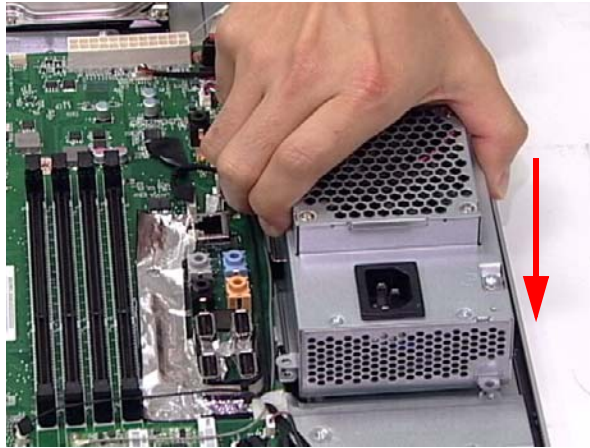

2. Secure the Power Supply using two (2) screws.

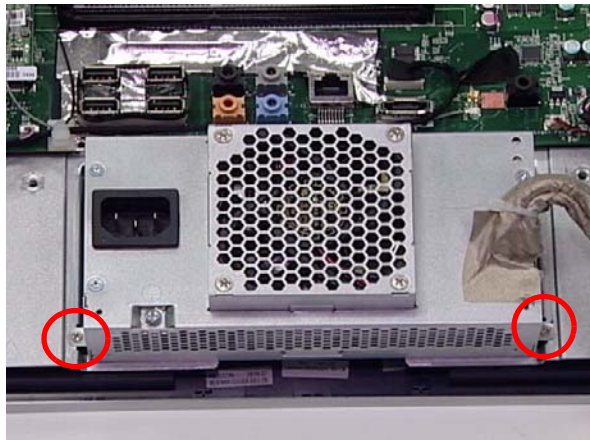

Replacing the Back Frame

1. Place one end of the Back Frame (1) in the device as shown. Line up the guide (2) before replacing completely.

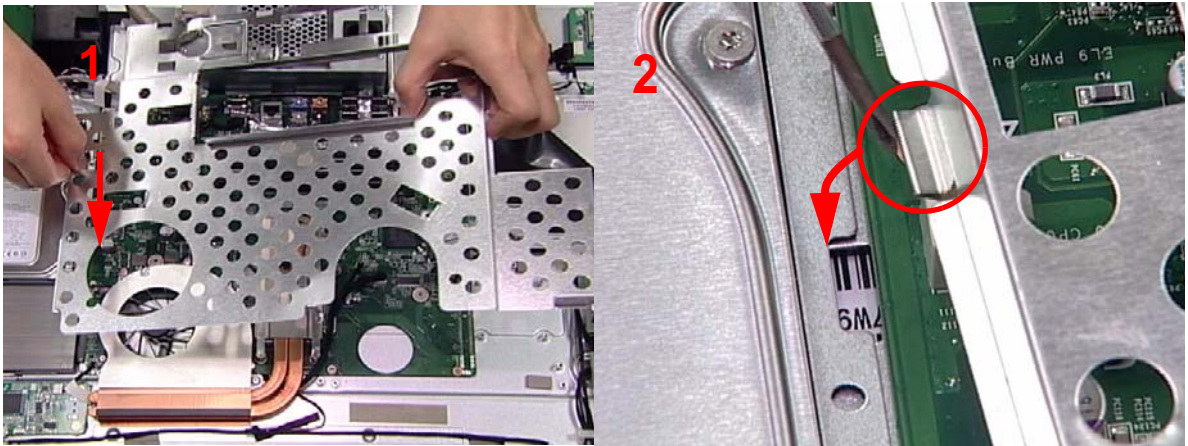

2. Secure the Back Frame using nine (9) screws.

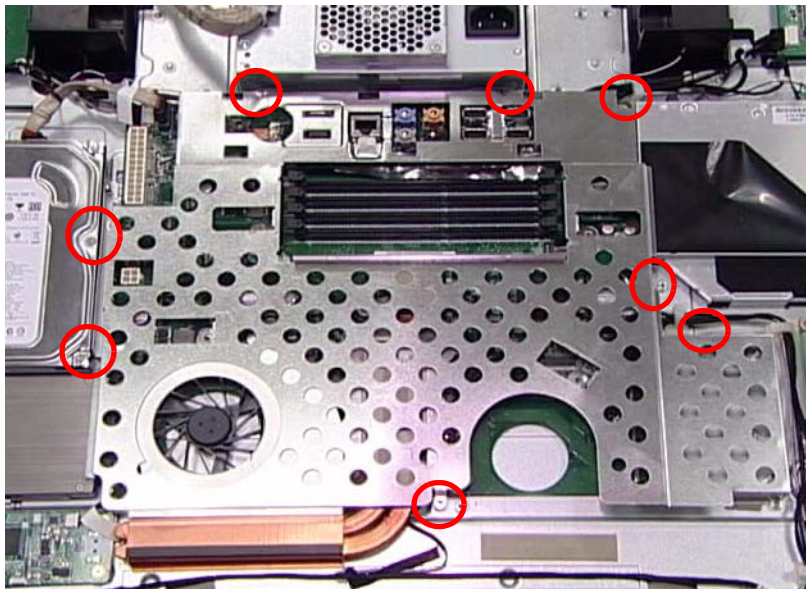

3. Connect the CPU Power Cable (A), the SATA Power Cable(B), and the HDD Power Cable (C)

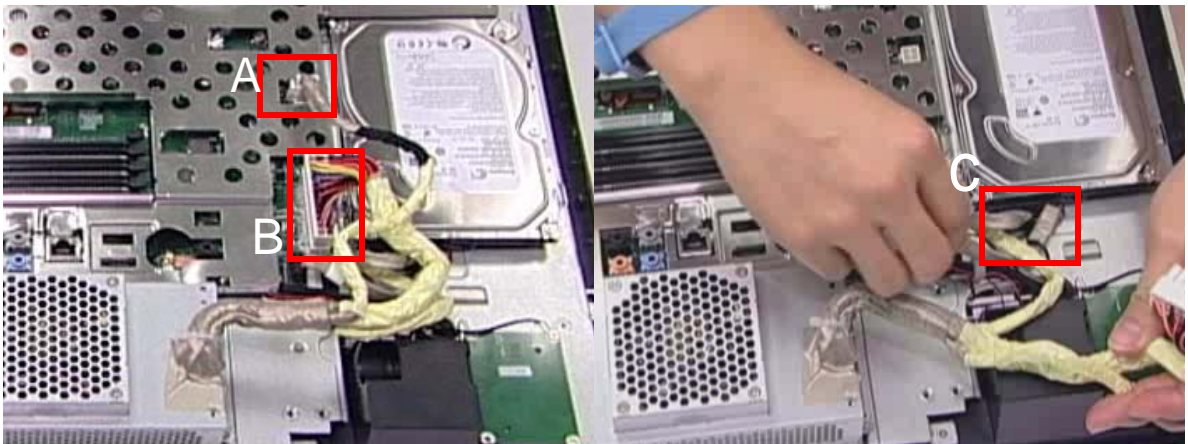

4. Attach the EMI Cable Mylar to the Back Frame as shown.

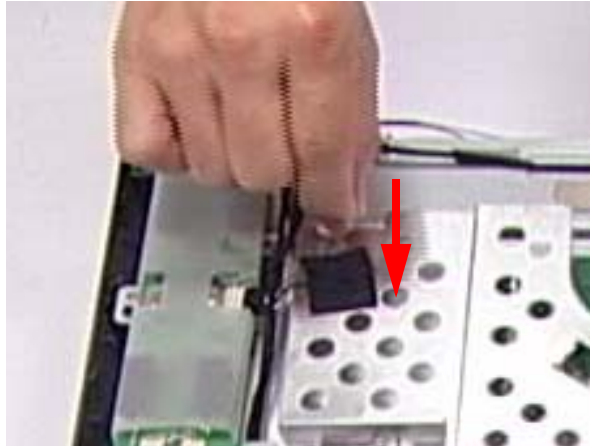

Replacing the Hinge

1. Replace the Hinge, noting the guide pin that must be lined up.

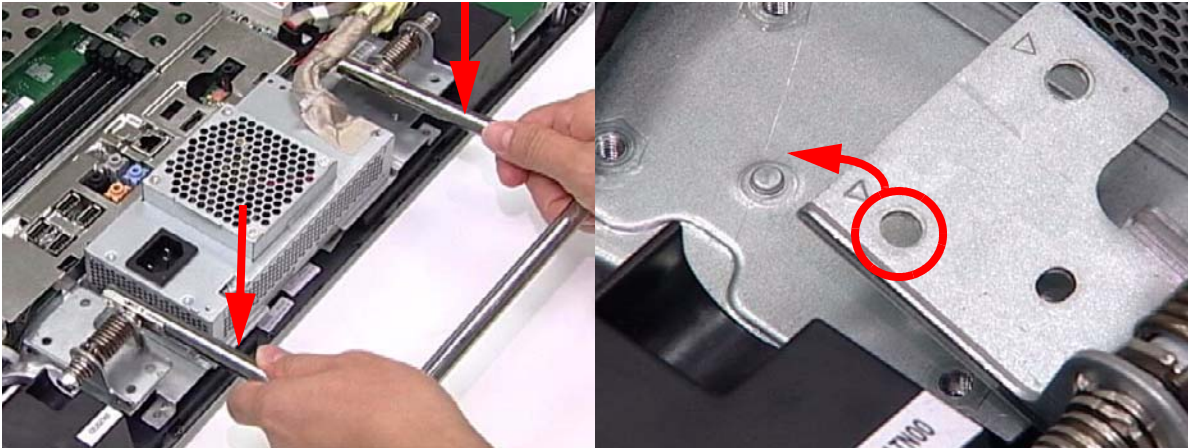

2. Secure the Hinge using six (6) screws.



Replacing the Back Cover

1. Snap the Back Cover into place using both hands. Make sure that all the guides have been securely locked.

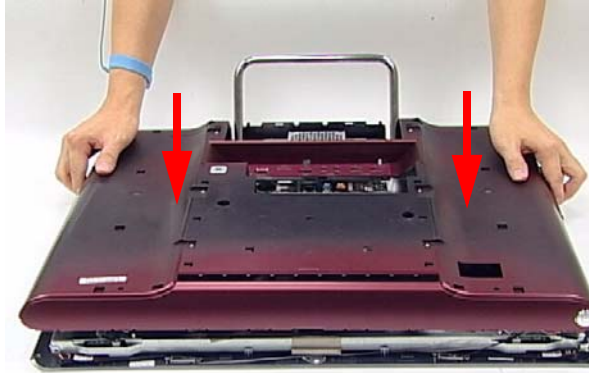

2. Move the Hinge down into the carry position. There is an audible click when the Hinge is locked in position.

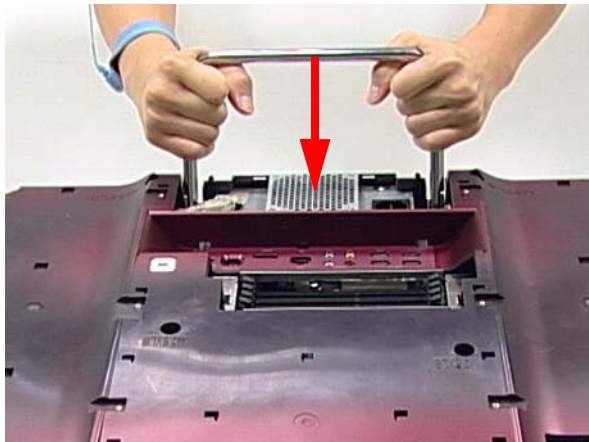

3. Secure the Back Cover using fourteen (14) screws.

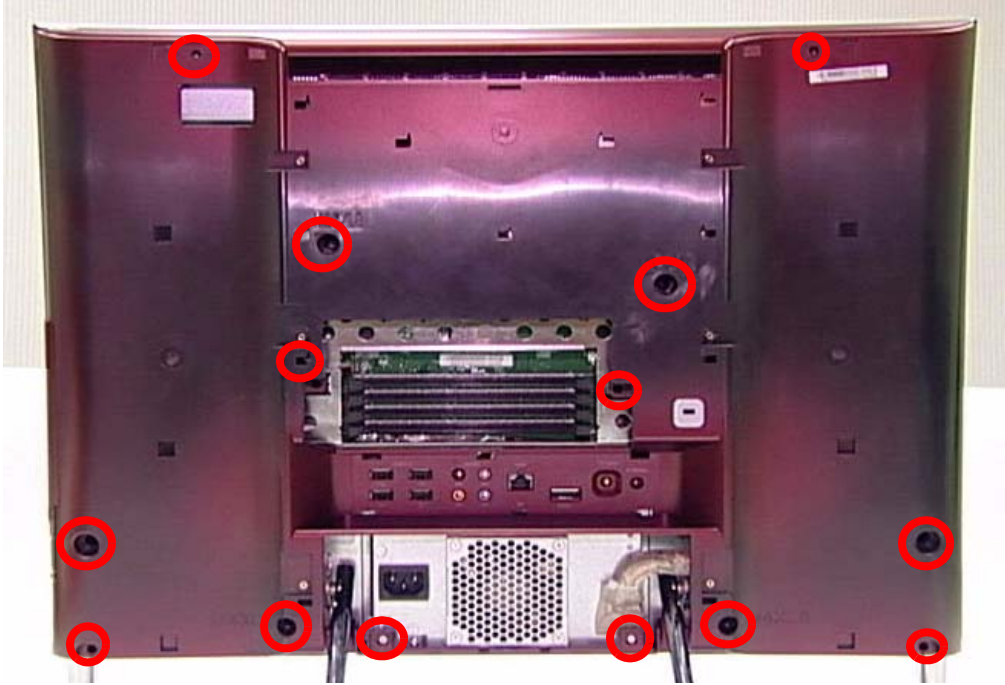

Replacing the Rear Covers

1. Replace the Rear Cover by pushing inward as shown

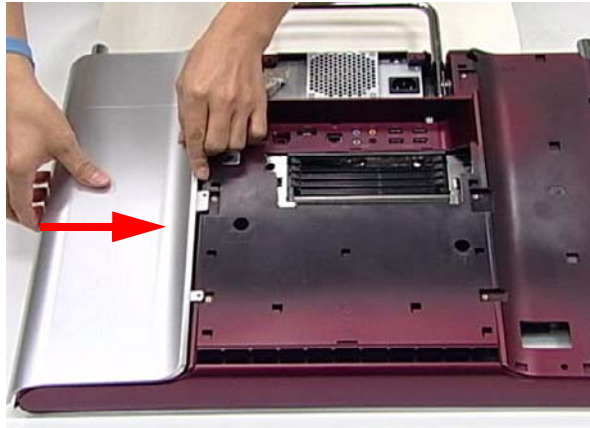

2. Repeat the previous step for the remaining Rear Cover.

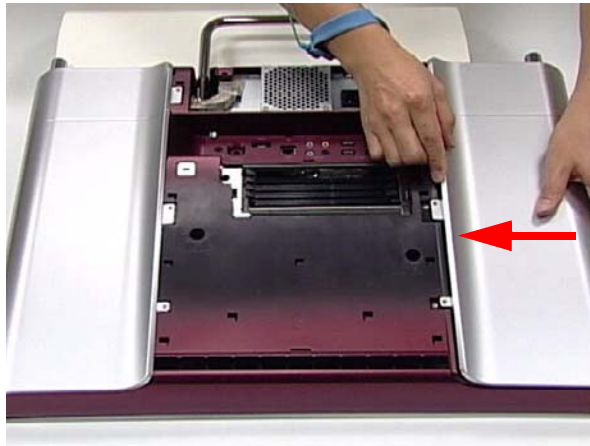

3. Secure the Rear Covers using six (6) screws.

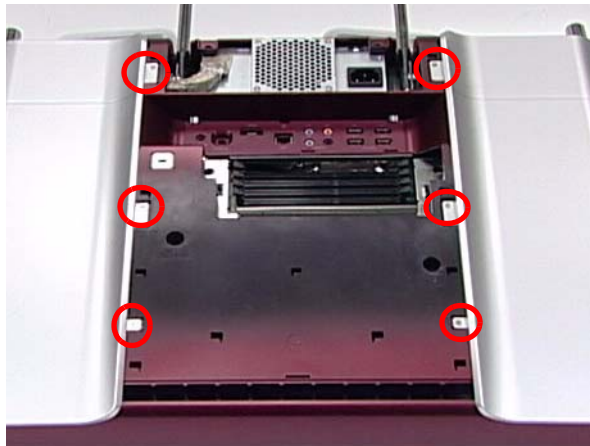

Replacing the RAM

1. Firmly place each Ram into its slot until a click is heard. Make sure the latches are in the lock position.

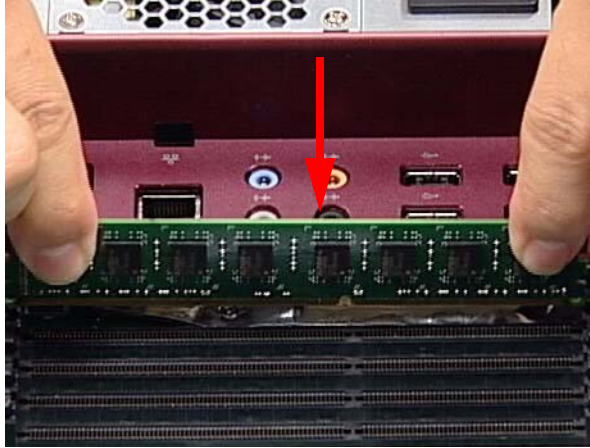

2. Replace the Ram Shielding.

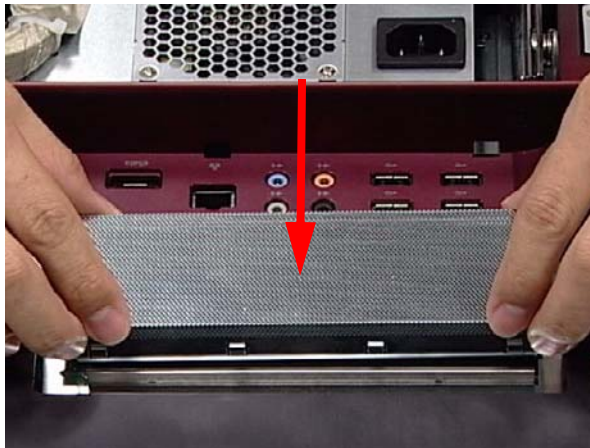

Replacing the Hinge Cover

1. Grasp the Hinge Cover with both hands.

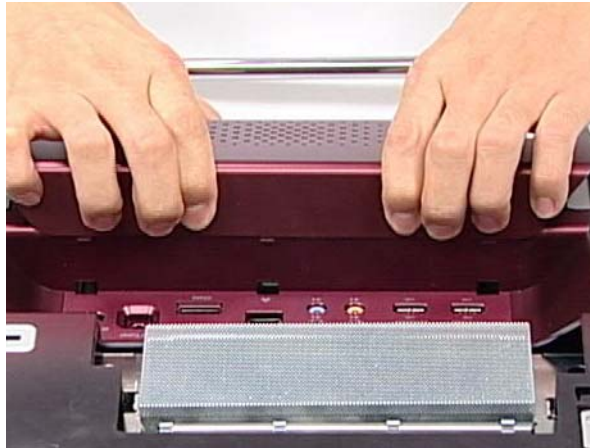

2. Gently push the Hinge Cover down until it snaps into place.

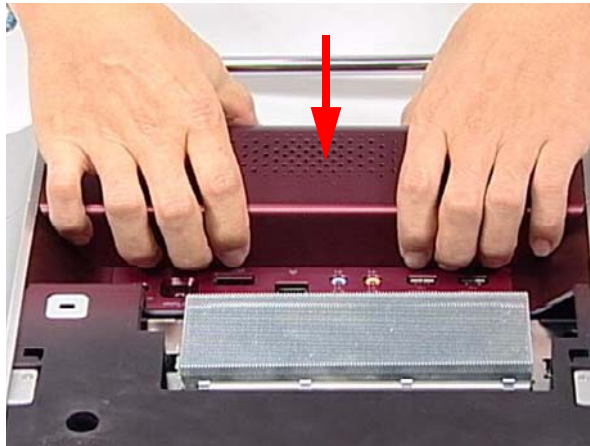

Replacing the RAM Cover

1. Line up one end of the RAM Cover with the device as shown.



2. Push down with both hands until the cover snaps into place.



Troubleshooting

Common Problems

Use the following procedure as a guide for computer problems.

NOTE: The diagnostic tests are intended to test only Acer products. Non-Acer products, prototype cards, or modified options can give false errors and invalid system responses.

1. Obtain the failing symptoms in as much detail as possible.
2. Verify the symptoms by attempting to re-create the failure by running the diagnostic test or by repeating the same operation.
3. Use the troubleshooting sections to try and resolve the issue.

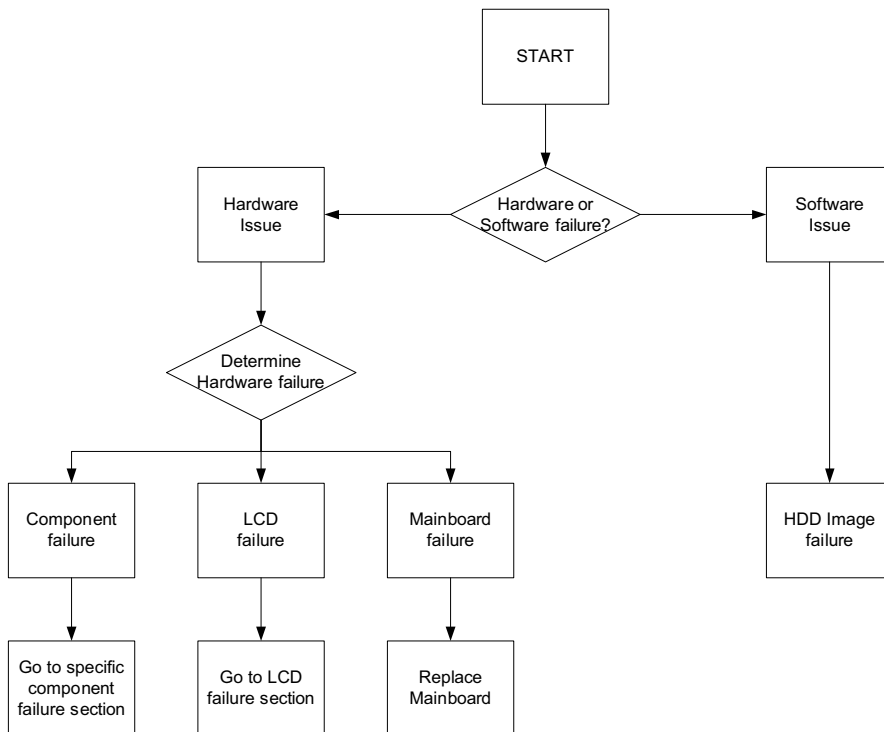

4. If the Issue is still not resolved, see "Online Support Information" on page 197.

ODD Failure

If an Optical Disk Drive failure is determined, use the following flowchart to determine the required action:

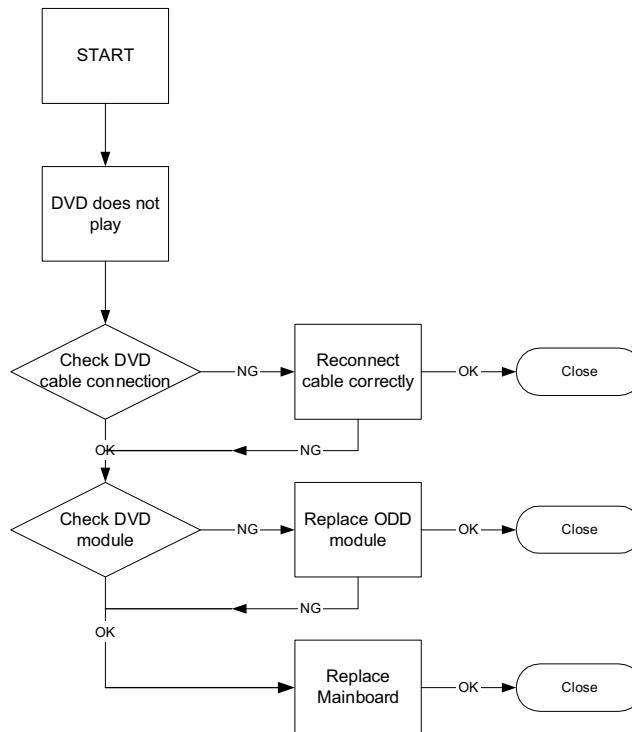

ODD Not Operating Correctly

If the **ODD** exhibits any of the following symptoms it may be faulty:

- Audio CDs do not play when loaded
- DVDs do not play when loaded
- Blank discs do not burn correctly
- DVD or CD play breaks up or jumps
- Optical drive not found or not active:
 - Not shown in My Computer or the BIOS setup
 - LED does not flash when the computer starts up
 - The tray does not eject
- Access failure screen displays
- The ODD is noisy

Perform the following general solutions one at a time to correct the problem.

1. Reboot the computer and retry the operation.
2. Try an alternate disc.
3. Navigate to **Start** → **Computer**. Check that the ODD device is displayed in the **Devices with Removable Storage** panel.
4. Navigate to **Start** → **Control Panel** → **System and Maintenance** → **System** → **Device Manager**.
 - a. Double-click **IDE ATA/ATAPI controllers**. If a device displays a down arrow, right-click on the device and click **Enable**.

-
- b. Double-click **DVD/CD-ROM drives**. If the device displays a down arrow, right-click on the device and click **Enable**.
 - c. Check that there are no yellow exclamation marks against the items in **IDE ATA/ATAPI controllers**. If a device has an exclamation mark, right-click on the device and uninstall and reinstall the driver.
 - d. Check that there are no yellow exclamation marks against the items in **DVD/CD-ROM drives**. If a device has an exclamation mark, right-click on the device and uninstall and reinstall the driver.
 - e. If the exclamation marker is not removed from the item in the lists, try removing any recently installed software and retrying the operation.

Discs Do Not Play

If discs do not play when inserted in the drive, perform the following actions one at a time to correct the problem.

1. Check that the disc is correctly seated in the drive tray and that the label on the disc is visible.
2. Check that the media is clean and scratch free.
3. Try an alternate disc in the drive.
4. Ensure that **AutoPlay** is enabled:
 - a. Navigate to **Start**→ **Control Panel**→ **Hardware and Sound**→ **AutoPlay**.
 - b. Select **Use AutoPlay for all media and devices**.
 - c. In the Audio CD and DVD Movie fields, select the desired player from the drop down menu.
5. Check that the Regional Code is correct for the selected media:

IMPORTANT:Region can only be changed a limited number of times. After Changes remaining reaches zero, the region cannot be changed even Windows is reinstalled or the drive is moved to another computer.

- a. Navigate to **Start**→ **Control Panel**→ **System and Maintenance**→ **System**→ **Device Manager**.
- b. Double-click **DVD/CD-ROM drives**.
- c. Right-click **DVD drive** and click **Properties**, then click the **DVD Region** tab.
- d. Select the region suitable for the media inserted in the drive.

Discs Do Not Burn Properly

If discs can not be burned, perform the following actions one at a time to correct the problem.

1. Ensure that the default drive is record enabled:
 - a. Navigate to **Start**→ **Computer** and right-click the writable ODD icon. Click **Properties**.
 - b. Select the **Recording** tab. In the **Desktop disc recording** panel, select the writable ODD from the drop down list.
 - c. Click **OK**.
2. Ensure that the software used for burning discs is the factory default. If using different software, refer to the software's user manual.

Playback is Choppy

If playback is choppy or jumps, perform the following actions one at a time to correct the problem.

1. Check that system resources are not running low:
 - a. Try closing some applications.
 - b. Reboot and try the operation again.
2. Check that the ODD controller transfer mode is set to DMA:
 - a. Navigate to **Start**→ **Control Panel**→ **System and Maintenance**→ **System**→ **Device Manager**.
 - b. Double-click **IDE ATA/ATAPI controllers**, then right-click ATA Device 0.

-
- c. Click **Properties** and select the **Advanced Settings** tab. Ensure that the **Enable DMA** box is checked and click **OK**.
 - d. Repeat for the other ATA Devices shown if applicable.

Drive Not Detected

If Windows cannot detect the drive, perform the following actions one at a time to correct the problem.

1. Restart the computer and press F2 to enter the BIOS Utility.
2. Check that the drive is detected in the **ATAPI Model Name** field on the Information page.
NOTE: Check that the entry is identical to one of the ODDs specified in “Hardware Specifications and Configurations” on page 17.
3. Turn off the power and remove the cover to inspect the connections to the ODD. See “Disassembly Process” on page 42.
 - a. Check for broken connectors on the drive, motherboard, and cables.
 - b. Check for bent or broken pins on the drive, motherboard, and cable connections.
 - c. Try an alternate cable, if available. If the drive works with the new cable, the original cable should be replaced.
4. Reseat the drive ensuring and all cables are connected correctly.
5. Replace the ODD. See “Disassembly Process” on page 42.

Drive Read Failure

If discs cannot be read when inserted in the drive, perform the following actions one at a time to correct the problem.

1. Remove and clean the failed disc.
2. Retry reading the CD or DVD.
 - d. Test the drive using other discs.
 - e. Play a DVD movie
 - f. Listen to a music CD

If the ODD works properly with alternate discs, the original disc is probably defective and should be replaced.

3. Turn off the power and remove the cover to inspect the connections to the ODD. See “Disassembly Process” on page 42.
 - a. Check for broken connectors on the drive, motherboard, and cables.
 - b. Check for bent or broken pins on the drive, motherboard, and cable connections.
 - c. Try an alternate cable, if available. If the drive works with the new cable, the original cable should be replaced.
4. Replace the ODD. See “Disassembly Process” on page 42.

Wireless Failure

If the wireless functionality fails, use the following flowchart to determine the required action:

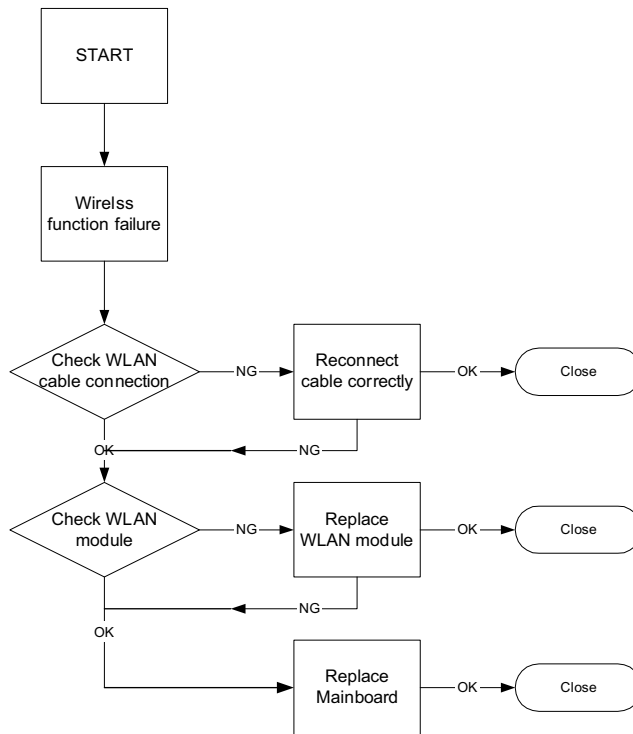

Camera Failure

If the camera functionality fails, use the following flowchart to determine the required action:

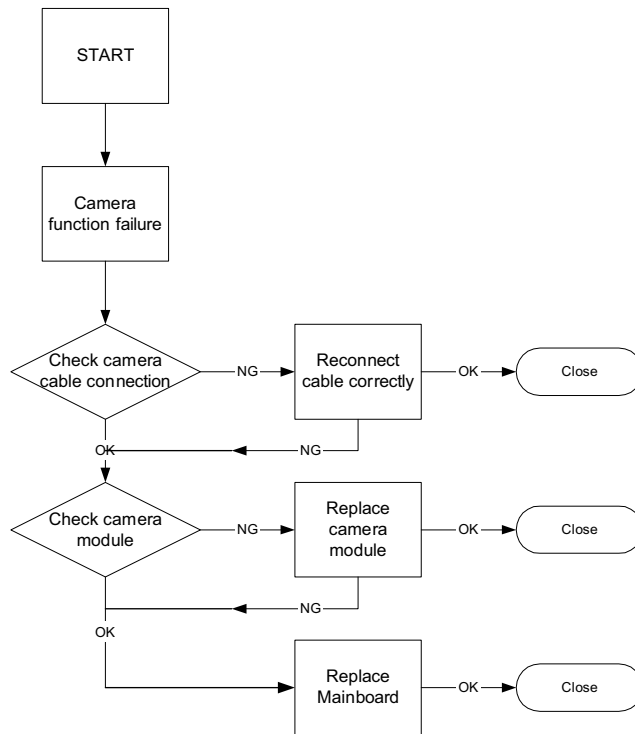

Speaker Failure

If the internal speaker fails, use the following flowchart to determine the required action:

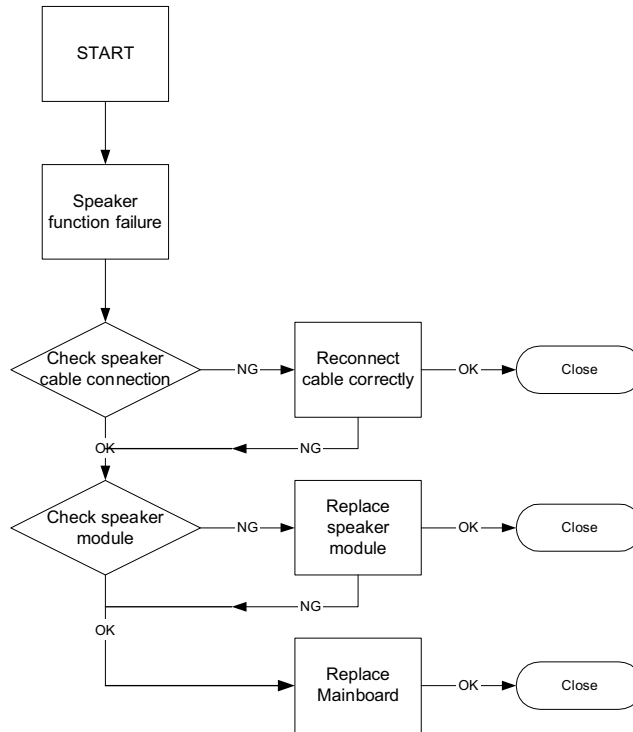

Sound Problems

If sound problems are experienced, perform the following actions one at a time to correct the problem.

1. Reboot the computer.
2. Navigate to **Start** → **Control Panel** → **System and Maintenance** → **System** → **Device Manager**. Check the Device Manager to determine that:
 - The device is properly installed.
 - There are no red Xs or yellow exclamation marks.
 - There are no device conflicts.
 - No hardware is listed under Other Devices.
3. Roll back the audio driver to the previous version, if updated recently.
4. Remove and reinstall the audio driver.
5. Ensure that all volume controls are set mid range:
 - a. Click the volume icon on the taskbar and drag the slider to 50. Ensure that the volume is not muted.
 - b. Click Mixer to verify that other audio applications are set to 50 and not muted.
6. Navigate to **Start** → **Control Panel** → **Hardware and Sound** → **Sound**. Ensure that Speakers are selected as the default audio device (green check mark).

NOTE: If Speakers does not show, right-click on the **Playback** tab and select **Show Disabled Devices** (clear by default).
7. Select Speakers and click **Configure** to start **Speaker Setup**. Follow the onscreen prompts to configure the speakers.
8. Remove and recently installed hardware or software.

-
9. Restore system and file settings from a known good date using **System Restore**.
If the issue is not fixed, repeat the preceding steps and select an earlier time and date.
 10. Reinstall the Operating System.
 11. If the Issue is still not resolved, see "Online Support Information" on page 175.

LCD Failure

If the integrated LCD display fails, use the following flowchart to determine the required action:

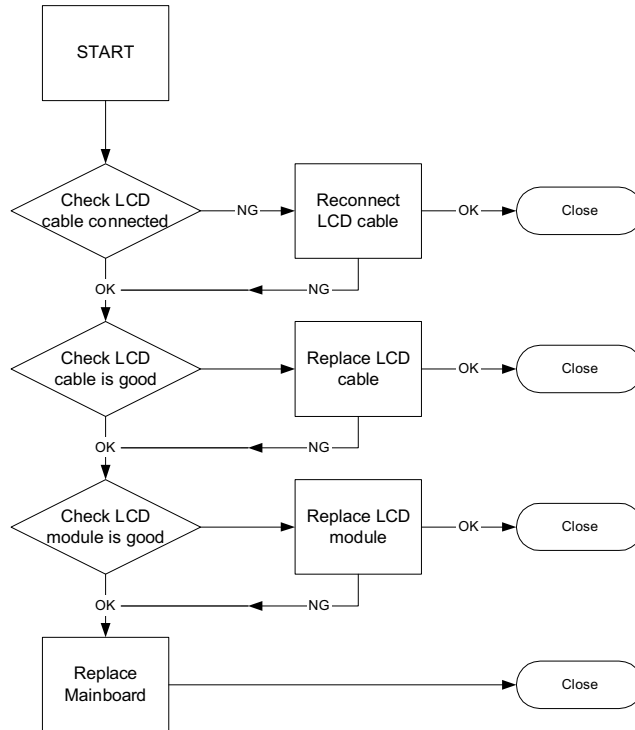

No POST or Video

If the POST or video doesn't display, perform the following actions one at a time to correct the problem.

1. Make sure the computer has power by checking at least one of the following occurs:
 - Fans start up
 - Status LEDs light up
2. Drain any stored power by removing the power cable and battery and holding down the power button for 10 seconds. Reconnect the power and reboot the computer.
3. Disconnect power and all external devices including port replicators or docking stations. Remove any memory cards and CD/DVD discs. Restart the computer.

If the computer boots correctly, add the devices one by one until the failure point is discovered.
4. Reseat the memory modules.
5. Remove the drives (see "Disassembly Process" on page 42).
6. If the Issue is still not resolved, see "Online Support Information" on page 175.

Abnormal Video Display

If video displays abnormally, perform the following actions one at a time to correct the problem.

1. Reboot the computer.
2. If permanent vertical/horizontal lines or dark spots display in the same location, the LCD is faulty and should be replaced. See “Disassembly Process” on page 42.
3. If extensive pixel damage is present (different colored spots in the same locations on the screen), the LCD is faulty and should be replaced. See “Disassembly Process” on page 42.
4. Adjust the brightness to its highest level. See the User Manual for instructions on adjusting settings.
NOTE: Ensure that the computer is not running on battery alone as this may reduce display brightness.
If the display is too dim at the highest brightness setting, the LCD is faulty and should be replaced. See “Disassembly Process” on page 42.
5. Check the display resolution is correctly configured:
 - a. Minimize or close all Windows.
 - b. If display size is only abnormal in an application, check the view settings and control/mouse wheel zoom feature in the application.
 - c. If desktop display resolution is not normal, right-click on the desktop and select **Personalize**→ **Display Settings**.
 - d. Click and drag the Resolution slider to the desired resolution.
 - e. Click **Apply** and check the display. Readjust if necessary.
6. Roll back the video driver to the previous version if updated.
7. Remove and reinstall the video driver.
8. Check the Device Manager to determine that:
 - The device is properly installed. There are no red Xs or yellow exclamation marks.
 - There are no device conflicts.
 - No hardware is listed under Other Devices.
9. If the Issue is still not resolved, see “Online Support Information” on page 175.
10. Run the Windows Memory Diagnostic from the operating system DVD and follow the onscreen prompts.
11. If the Issue is still not resolved, see “Online Support Information” on page 175.

General Troubleshooting Issues

Computer Shutdown Intermittently

If the system powers off at intervals, perform the following actions one at a time to correct the problem.

1. Check the power cable is properly connected to the computer and the electrical outlet.
2. Remove any extension cables between the computer and the outlet.
3. Remove any surge protectors between the computer and the electrical outlet. Plug the computer directly into a known good electrical outlet.
4. Disconnect the power and open the casing to check the Thermal Unit and fan airways are free of obstructions.
5. Remove all external and non-essential hardware connected to the computer that are not necessary to boot the computer to the failure point.
6. Remove any recently installed software.
7. If the Issue is still not resolved, see “Online Support Information” on page 175.

Random Loss of BIOS Settings

If the computer is experiencing intermittent loss of BIOS information, perform the following actions one at a time to correct the problem.

1. If the computer is more than one year old, replace the CMOS battery.
2. Run a complete virus scan using up-to-date software to ensure the computer is virus free.
3. If the computer is experiencing HDD or ODD BIOS information loss, disconnect and reconnect the power and data cables between devices.
If the BIOS settings are still lost, replace the cables.
4. If HDD information is missing from the BIOS, the drive may be defective and should be replaced.
5. Replace the Motherboard.
6. If the Issue is still not resolved, see “Online Support Information” on page 175.

Microphone Problems

If internal or external **Microphones** do not operate correctly, perform the following actions one at a time to correct the problem.

1. Check that the microphone is enabled. Navigate to **Start** → **Control Panel** → **Hardware and Sound** → **Sound** and select the **Recording** tab.
2. Right-click on the **Recording** tab and select **Show Disabled Devices** (clear by default).
3. The microphone appears on the **Recording** tab.
4. Right-click on the microphone and select **Enable**.
5. Select the microphone then click **Properties**. Select the **Levels** tab.
6. Increase the volume to the maximum setting and click **OK**.
7. Test the microphone hardware:
 - a. Select the microphone and click **Configure**.
 - b. Select **Set up microphone**.
 - c. Select the microphone type from the list and click **Next**.
 - d. Follow the onscreen prompts to complete the test.
8. If the Issue is still not resolved, see “Online Support Information” on page 175.

HDD Not Operating Correctly

If the **HDD** does not operate correctly, perform the following actions one at a time to correct the problem.

1. Disconnect all external devices.
2. Run a complete virus scan using up-to-date software to ensure the computer is virus free.
3. Run the Windows 7 Startup Repair Utility:
 - a. insert the Windows 7 Operating System DVD in the ODD and restart the computer.
 - b. When prompted, press any key to start to the operating system DVD.
 - c. The **Install Windows** screen displays. Click **Next**.
 - d. Select **Repair your computer**.
 - e. The **System Recovery Options** screen displays. Click **Next**.
 - f. Select the appropriate operating system, and click **Next**.

NOTE: Click **Load Drivers** if controller drives are required.

- g. Select **Startup Repair**.
- h. Startup Repair attempts to locate and resolve issues with the computer.
- i. When complete, click **Finish**.

If an issue is discovered, follow the onscreen information to resolve the problem.

4. Run the Windows Memory Diagnostic Tool. For more information see Windows Help and Support.
5. Restart the computer and press F2 to enter the BIOS Utility. Check the BIOS settings are correct and that CD/DVD drive is set as the first boot device on the Boot menu.
6. Ensure all cables and jumpers on the HDD and ODD are set correctly.
7. Remove any recently added hardware and associated software.
8. Run the Windows Disk Defragmenter. For more information see Windows Help and Support.
9. Run Windows Check Disk by entering **chkdsk /r** from a command prompt. For more information see Windows Help and Support.
10. Restore system and file settings from a known good date using **System Restore**.
If the issue is not fixed, repeat the preceding steps and select an earlier time and date.
11. Replace the HDD. See "Disassembly Process" on page 42.

External Mouse Failure

If an external **Mouse** fails, perform the following actions one at a time to correct the problem.

1. Try an alternative mouse.
2. If the mouse uses a wireless connection, insert new batteries and confirm there is a good connection. See the mouse user manual.
3. If the mouse uses a USB connection, try an alternate USB port.
4. Try an alternative program to verify mouse operation. Reinstall the program experiencing mouse failure.
5. Restart the computer.
6. Remove any recently added hardware and associated software.
7. Remove any recently added software and reboot.
8. Restore system and file settings from a known good date using **System Restore**.

If the issue is not fixed, repeat the preceding steps and select an earlier time and date.

9. Run the Event Viewer to check the events log for errors. For more information see Windows Help and Support.
10. Roll back the mouse driver to the previous version if updated recently.

-
- 11.** Remove and reinstall the mouse driver.
 - 12.** Check the Device Manager to determine that:
 - The device is properly installed. There are no red Xs or yellow exclamation marks.
 - There are no device conflicts.
 - No hardware is listed under Other Devices.
 - 13.** If the Issue is still not resolved, see “Online Support Information” on page 175.

Intermittent Problems

Intermittent system hang problems can be caused by a variety of reasons that have nothing to do with a hardware defect, such as: cosmic radiation, electrostatic discharge, or software errors. FRU replacement should be considered only when a recurring problem exists.

When analyzing an intermittent problem, do the following:

1. Run the advanced diagnostic test for the system board in loop mode at least 10 times.
2. If no error is detected, do not replace any FRU.
3. If any error is detected, replace the FRU. Rerun the test to verify that there are no more errors.

Undetermined Problems

The diagnostic problems does not identify which adapter or device failed, which installed devices are incorrect, whether a short circuit is suspected, or whether the system is inoperative.

Follow these procedures to isolate the failing FRU (do not isolate non-defective FRU).

NOTE: Verify that all attached devices are supported by the computer.

NOTE: Verify that the power supply being used at the time of the failure is operating correctly.

1. Power-off the computer.
2. Visually check for damage. If any problems are found, replace the FRU.
3. Remove or disconnect all of the following devices:
 - Non-Acer devices
 - Printer, mouse, and other external devices
 - Hard disk drive
 - DIMM
 - CD-ROM/Diskette drive Module
4. Power-on the computer.
5. Determine if the problem has changed.
6. If the problem does not recur, reconnect the removed devices one at a time until you find the failing FRU.
7. If the Issue is still not resolved, see "Online Support Information" on page 175.

Jumper and Connector Locations

Top View

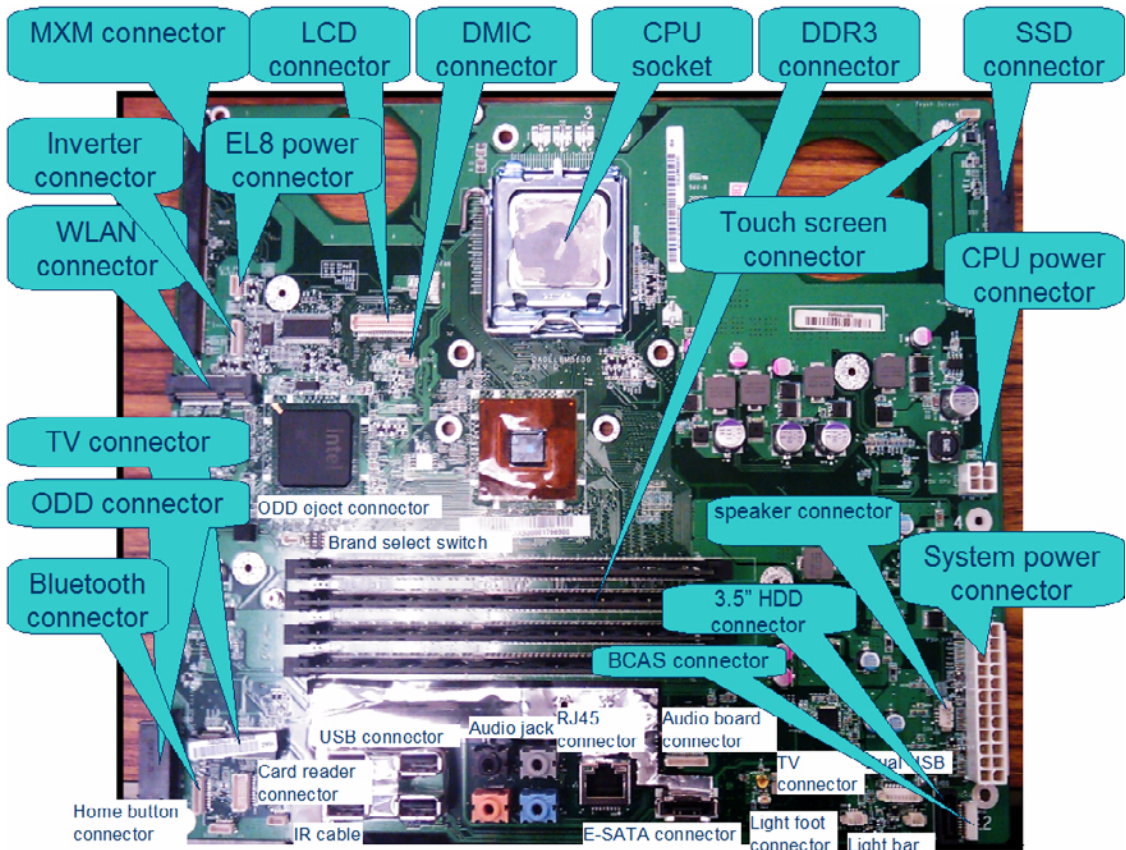

Item	Description	Item	Description
CPU	CPU/Processor socket	WLAN	Wireless LAN card connector
DDR3	DDR3 SODIMM sockets	Inverter	LCD inverter connector
FAN	CPU fan connector	Board to Board	Mainboard to daughter board connector
MXM	MXM connector	DMIC	DMIC connector
SSD	SSD connector	EL8	EL8 power connector
Touch Screen	Touch screen connector	CPU Power	CPU Power connector
TV	TV connector	ODD	ODD connector
Speaker	Speaker connector	Bluetooth	Bluetooth connector
BCAS	BCAS connector	System Power	System power connector
Webcam	Webcam connector	HDD	3.5" HDD connector

Bottom View

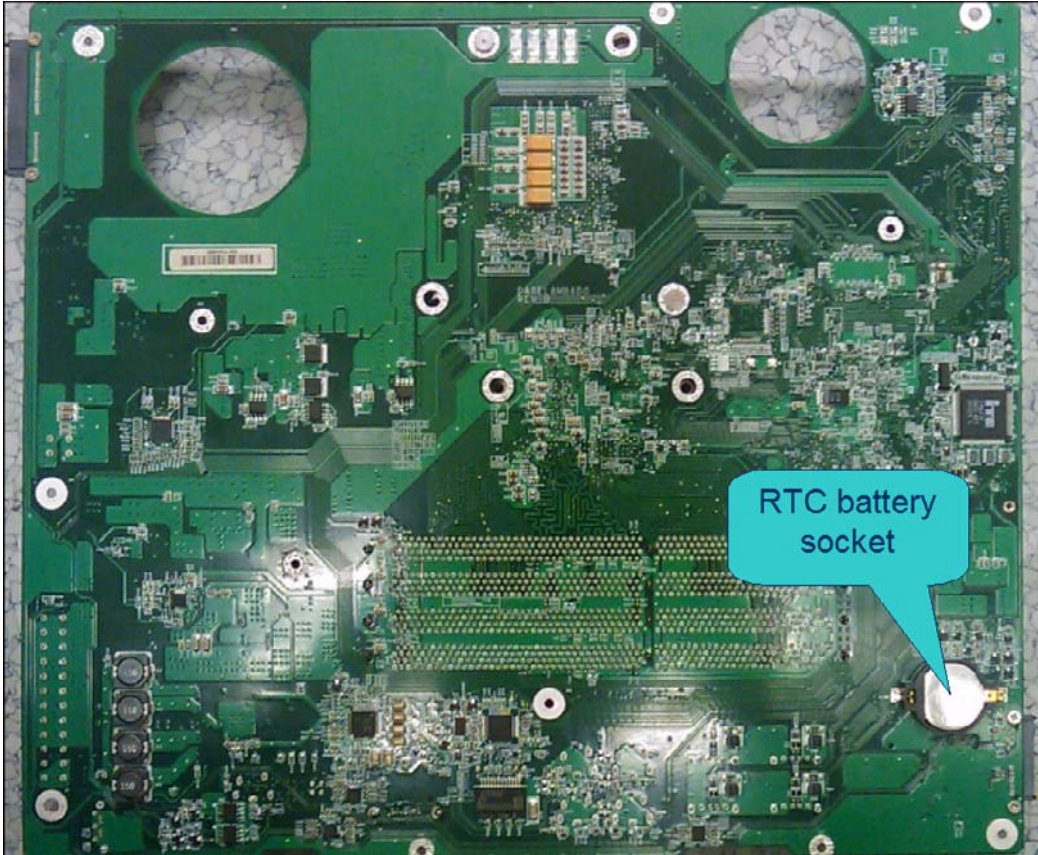

Item	Description
RTC	RTC battery socket

Clearing Password Check and BIOS Recovery

This section provide you the standard operating procedures of clearing password and BIOS recovery for Aspire Z5600/Z5610 Series. Aspire Z5600/Z5610 Series provides one Hardware Open Gap on main board for clearing password check, and one Hotkey for enabling BIOS Recovery.

Clearing Password Check

Hardware Open Gap Description

Item	Description	Location
CLRP2 (RTC (RST))	Clear CMOS Jumper	DIMM Bay



Steps for Clearing BIOS Password Check

If users set BIOS Password (Supervisor Password and/or User Password) for a security reason, BIOS will ask the password during systems POST or when systems enter to BIOS Setup menu. However, once it is necessary to bypass the password check, users need to short the HW Gap to clear the password by the following steps:

- Power Off a system, and remove HDD, AC and Battery from the machine.
- Open the back cover of the machine, and find out the HW Gap on M/B as picture.
- Use an electric conductivity tool to short the two points of the HW Gap.
- Plug in AC, keep the short condition on the HW Gap, and press Power Button to power on the system till BIOS POST finish. Then remove the tool from the HW Gap.
- Restart system. Press F2 key to enter BIOS Setup menu.
- If there is no Password request, BIOS Password is cleared. Otherwise, please follow the steps and try again.

NOTE: The steps are only for clearing BIOS Password (Supervisor Password and User Password).

BIOS Recovery by Crisis Disk

BIOS Recovery Boot Block:

BIOS Recovery Boot Block is a special block of BIOS. It is used to boot up the system with minimum BIOS initialization. Users can enable this feature to restore the BIOS firmware to a successful one once the previous BIOS flashing process failed.

BIOS Recovery Hotkey:

The system provides a function hotkey: **Fn+Esc**, for enable BIOS Recovery process when system is powered on during BIOS POST. To use this function, it is strongly recommended to have the AC adapter and Battery present. If this function is enabled, the system will force the BIOS to enter a special BIOS block, called Boot Block.

Steps for BIOS Recovery from USB Storage:

Before doing this, prepare the Crisis USB key. The Crisis USB key could be made by executing the Crisis Disk program in another system with Windows XP OS.

Follow the steps below:

1. Save ROM file (file name: **JAL90x64.fd**) to the root directory of USB storage.
2. Plug USB storage into USB port.
3. Press **Fn + ESC** button then plug in AC.
The Power button flashes once.
4. Press **Power** button to initiate system CRISIS mode.
When CRISIS is complete, the system auto restarts with a workable BIOS.
5. Update the latest version BIOS for this machine by regular BIOS flashing process.

Steps for BIOS Recovery by Crisis Disk:

Before doing this, a Crisis Diskette should be prepared ready in hand. The Crisis Diskette could be made by executing the Crisis Disk program in another system with Windows XP OS.

Follow the steps below:

1. Power Off failed system.
2. Attach a USB floppy drive to the failed system.
3. Copy **xxxxx.wph** to tool's folder and rename it as **BIOS.wph**.
4. Execute **wincris.exe** to start the Crisis Disk Build.
5. Select **Removable** and click **Start**.

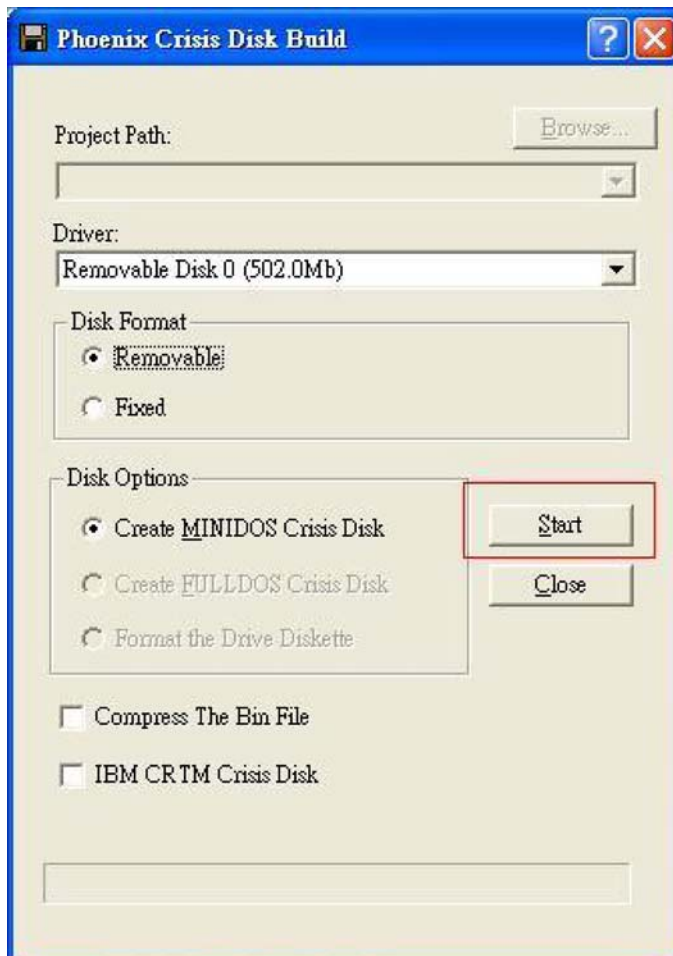

A confirmation screen displays.



6. Click the **OK** button on the left to continue.

-
7. Click the (N) button when prompted to complete the process.



8. Insert the Crisis Disk in to the USB floppy drive attached to the BIOS flash failed system.
9. In the power-off state, unplug the AC power and hold **Fn+Esc** then plug the AC power in.
10. Press the Power button.

The system powers on and the Crisis BIOS Recovery process begins.

BIOS Boot Block begins restoring the BIOS code from the Crisis floppy disk to BIOS ROM on the failed systems.

When the Crisis flash process is finished, the system restarts with a workable BIOS.

Update to the latest version BIOS for the system using the regular BIOS flashing process.

FRU (Field Replaceable Unit) List

This chapter gives you the FRU (Field Replaceable Unit) listing in global configurations of Aspire Z5600/Z5610 Series. Refer to this chapter whenever ordering for parts to repair or for RMA (Return Merchandise Authorization).

Please note that WHEN ORDERING FRU PARTS, you should check the most up-to-date information available on your regional web or channel. For whatever reasons a part number change is made, it will not be noted on the printed Service Guide. For ACER AUTHORIZED SERVICE PROVIDERS, your Acer office may have a DIFFERENT part number code from those given in the FRU list of this printed Service Guide. You MUST use the local FRU list provided by your regional Acer office to order FRU parts for repair and service of customer machines.

NOTE: To scrap or to return the defective parts, you should follow the local government ordinance or regulations on how to dispose it properly, or follow the rules set by your regional Acer office on how to return it.

Aspire Z5600/Z5610 Series Exploded Diagrams

Main Assembly

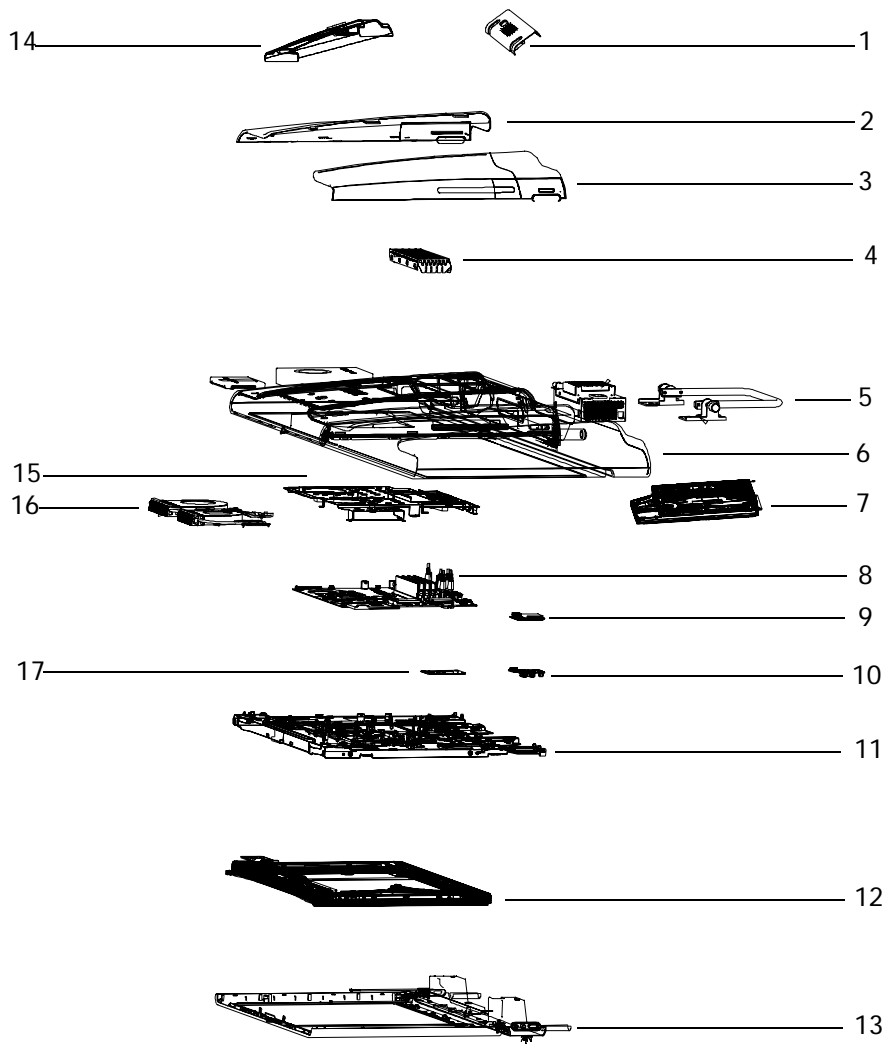

No.	Description	Acer P/N
1	Hinge Cover	42.SCY07.002
2	Rear Cover (L)	60.SCY07.005
3	Rear Cover (R)	60.SCY07.006
4	Ram Cover	33.SCY07.003
5	Hinge	60.SCY07.007
6	Power Supply	60.SCY07.002
7	ODD Module	33.SCY07.004
8	Main Board	MB.G8806.001
9	Card Reader Board	55.SCY07.002
10	Audio Board	55.SCY07.001
11	LCD Frame	33.SCY07.001
12	LCD Touch Panel	55.SCY07.003

No.	Description	Acer P/N
13	Front Bezel	60.SCY07.001
14	Back Cover	60.SCY07.002
15	Back Frame	33.SCY07.002
16	Fan Module UMA	23.SCY07.003
17	B-CAS Card	55.SCY07.005

FRU List

CATEGORY	Description	ACER PART NO.
ADD ON CARD		
	MSI VGA Card AMD M92XT DDRII 512M 500MHz 64*16 MXM 3.0 Type A w/ Hynix H5PS1G63EFR-20L	VG.M9206.008
	MSI VGA Card AMD M96XT DDRIII 1024M 900MHz 64*16 MXM 3.0 Type A w/ Samsung K4W1G1646D-EJ11	VG.M9606.011
BOARD		
	AUDIO BOARD	55.SCY07.001
	CARD READER BOARD	55.SCY07.002
	POWER BOARD	55.SCY07.003
	ODD BOARD	55.SCY07.004
	B CAS BOARD	55.SCY07.005
	HOME BUTTON BOARD	55.SCY07.006
	INVERTER BOARD DA-4A12-QT03L	19.SCY07.001
	INVERTER BOARD IV40157/T-LF	19.SCY07.002
WLAN		

CATEGORY	Description	ACER PART NO.
	Quanta Q802XKN6 WLAN Realtek RTL8187B PCI-Express Q802XKN6, Ralink RT3090 802.11b/g/n 1Tx1R WLAN(mini-card) Full Size	NI.10200.031
	Lite-On WN6500M, Marvell MC85 802.11 b/g/n (mini-card) Marvell MC85, 802.11 b/g/n WLAN mini-card, 2Tx3R,	NI.10200.015
Bluetooth		
	QMI QBT400UB Bluetooth Qcom Technology Inc., Broadcom BCM2046, Bluetooth2.1 + EDR, USB interface module	BT.14500.001
WEBCAM		
	Chicony Web Cam USB Panda 11-E	PC.13400.009
TV Tuner		
	AverMedia A336-D Mini-Card WW Analog + DVB-T Digital	TU.10500.052
	AverMedia A336-A Mini-Card WW Analog + ATSC Digital	TU.10500.051
Remote Controller		
	Philips Vista MCE iconized RC with 2 batteries for EMEA	RT.11300.005
	Philips Vista MCE iconized RC with 2 batteries for US	RT.11300.006
IR Blaster		
	SMK IR BLASTER RWS9000-1301FP	RV.RWS07.001
POWER CORD		
	POWER CORD 1.8M BLACK EU 3P	27.SCY07.001
CABLE		
	CABLE - AUDIO/B TO MB	50.SCY07.001
	LVDS CABLE	50.SCY07.002
	HDD CABLE	50.SCY07.003
	ODD CABLE	50.SCY07.004
	CABLE - CONTROL BORAD TO SENSOR/R	50.SCY07.005
	CABLE - CONTROL BORAD TO SENSOR/L	50.SCY07.006
	IR CABLE	50.SCY07.007



CATEGORY	Description	ACER PART NO.
	INVERTER CABLE	50.SCY07.008
	LED CABLE	50.SCY07.009
	USB CABLE W/PORT	50.SCY07.010
	POWER CABLE	50.SCY07.011
	CARD READER CABLE	50.SCY07.012
	BLUETOOTH CABLE	50.SCY07.013
	TV TUNER CABLE	50.SCY07.014
	CABLE - MB TO CONTROL BOARD	50.SCY07.015
	HOME BUTTON CABLE	50.SCY07.016
	TV EXTERNAL ANTENNA - DVB-T	50.SCY07.017
	TV EXTERNAL ANTENNA - ATSC	50.G8507.011
CASE/COVER/BRACKET ASSEMBLY		
	FRONT COVER ASSY SILVER W/SPEAKER, ANTENNA,USB PORT,IR,HOME BUTTON/B	60.SCY07.001
	ANTENNA	50.SCY07.018
	BACK COVER ASSY RED - MXM	60.SCY07.002
	BACK COVER ASSY RED - UMA	60.SCY07.003
	RAM COVER - RED	42.SCY07.001
	HINGE COVER	42.SCY07.002
	REAR COVER SILVER - LEFT W/O B-CAS	60.SCY07.004
	REAR COVER SILVER - LEFT W/B CAS	60.SCY07.005
	REAR COVER SILVER - RIGHT	60.SCY07.006
	LCD FRAME	33.SCY07.001

CATEGORY	Description	ACER PART NO.
	BACK FRAME	33.SCY07.002
	FRAME RAM COVER	33.SCY07.003
	HINGE	60.SCY07.007
	SPEAKER SET	23.SCY07.005
	ODD BRACKET	33.SCY07.004
	HDD BRACKET	33.SCY07.005
	MXM BRACKET	33.SCY07.006
Heat SINK		
	CPU HEATSINK	23.SCY07.001
	VGA HEATSINK	23.SCY07.002
FAN		
	FAN MODULE - UMA	23.SCY07.003
	FAN MODULE - MXM	23.SCY07.004
CPU/PROCESSOR		

CATEGORY	Description	ACER PART NO.
	CPU Intel Pentium Dual-Core E2220 LGA 2.4G 1M 800 775 65W M-0	KC.22201.DEM
	CPU Intel Pentium Dual-Core E5200 LGA 2.5G 2M 800 775 65W	KC.52001.DEM
	CPU Intel Pentium Dual-Core E5300 LGA 2.6G 2M 800 775 65W M-0	KC.53001.DEM
	CPU Intel Pentium Dual-Core E5400 LGA 2.7G 2M 800 775 65W R-0 Dual Core	KC.54001.DEM
	CPU Intel Pentium Dual-Core E6300 LGA 2.8G 2M 1066 775 65W R-0	KC.63001.DEM
	CPU Intel Pentium Dual-Core E6500 LGA 2.93G 2M 1066 775 65W R-0 Dual Core	KC.65001.DEM
	CPU Intel Core2Dual E7300 LGA 2.66G 3M 1066 775 65W M-0	KC.73001.DE0
	CPU Intel Core2Dual E7400 LGA 2.8G 3M 1066 775 65W R-0 Dual Core,	KC.74001.DE0
	CPU Intel Core2Dual E7500 LGA 2.93G 3M 1066 775 65W R-0 Dual Core	KC.75001.DE0
	CPU Intel Core2Dual E7600 LGA 3.06G 3M 1066 775 65W R-0	KC.76001.DE0
	CPU Intel Core2Quad Q8200s LGA 2.33G 4M 1333 775 65W R-0 Quad Core	KC.82001.QQS
	CPU Intel Core2Dual E8400 LGA 3.0G 6M 1333 775 65W E-0	KC.84001.DEE
	CPU Intel Core2Quad Q8400s LGA 2.66G 4M 1333 775 65W R-0 Quad Core	KC.84001.QQS
	CPU Intel Core2Dual E8500 LGA 3.16G 6M 1333 775 65W E-0	KC.85001.DEE
	CPU Intel Core2Dual E8600 LGA 3.33G 6M 1333 775 65W E-0	KC.86001.DEE
CPU Intel Core2Quad Q9400s LGA 2.66G 6M 1333 775 65W R-0 Quad Core	KC.94001.QQS	
HDD/HARD DISK DRIVE		
	HDD SEAGATE 3.5" 7200rpm 320GB ST3320418AS(Pharaoh) SATA II 16MB LF F/W:CC44	KH.32001.015
	HDD WD 3.5" 7200rpm 640GB WD6400AAKS-22A7B2 XL320M 640G SATA II 16MB LF F/W:01.03B01	KH.64008.003
	HDD SEAGATE 3.5" 7200rpm 750GB ST3750528AS (Pharaoh) SATA II 32MB LF F/W:CC44	KH.75001.008
	HDD HGST 3.5" 7200rpm 1000GB HDT721010SLA360 Saturn SATA II 16MB LF F/W:31B	KH.01K07.002
KEYBOARD		
	Keyboard CHICONY KG-0766 RF2.4 104KS Silver US with new color AC-MT-010	KB.RF403.245
	Keyboard CHICONY KG-0766 RF2.4 104KS Silver Traditional Chinese with new color AC-MT-010	KB.RF403.246
	Keyboard CHICONY KG-0766 RF2.4 104KS Silver Simplified Chinese with new color AC-MT-010	KB.RF403.247
	Keyboard CHICONY KG-0766 RF2.4 104KS Silver US International with new color AC-MT-010	KB.RF403.248

CATEGORY	Description	ACER PART NO.
	Keyboard CHICONY KG-0766 RF2.4 104KS Silver Arabic/English with new color AC-MT-010	KB.RF403.249
	Keyboard CHICONY KG-0766 RF2.4 104KS Silver Thailand with new color AC-MT-010	KB.RF403.250
	Keyboard CHICONY KG-0766 RF2.4 105KS Silver Spanish with new color AC-MT-010	KB.RF403.251
	Keyboard CHICONY KG-0766 RF2.4 105KS Silver Portuguese with new color AC-MT-010	KB.RF403.252
	Keyboard CHICONY KG-0766 RF2.4 105KS Silver Canadian French with new color AC-MT-010	KB.RF403.253
	Keyboard CHICONY KG-0766 RF2.4 107KS Silver Brazilian Portuguese with new color AC-MT-010	KB.RF403.254
	Keyboard CHICONY KG-0766 RF2.4 109KS Silver Japanese with new color AC-MT-010	KB.RF403.255
	Keyboard CHICONY KG-0766 RF2.4 105KS Silver German with new color AC-MT-010	KB.RF403.256
	Keyboard CHICONY KG-0766 RF2.4 105KS Silver Italian with new color AC-MT-010	KB.RF403.257
	Keyboard CHICONY KG-0766 RF2.4 105KS Silver French with new color AC-MT-010	KB.RF403.258
	Keyboard CHICONY KG-0766 RF2.4 105KS Silver Swedish with new color AC-MT-010	KB.RF403.259
	Keyboard CHICONY KG-0766 RF2.4 105KS Silver UK with new color AC-MT-010	KB.RF403.260
	Keyboard CHICONY KG-0766 RF2.4 105KS Silver Dutch with new color AC-MT-010	KB.RF403.261
	Keyboard CHICONY KG-0766 RF2.4 105KS Silver Swiss/G with new color AC-MT-010	KB.RF403.262
	Keyboard CHICONY KG-0766 RF2.4 105KS Silver Belgium with new color AC-MT-010	KB.RF403.263
	Keyboard CHICONY KG-0766 RF2.4 105KS Silver Icelandic with new color AC-MT-010	KB.RF403.264
	Keyboard CHICONY KG-0766 RF2.4 105KS Silver Norwegian with new color AC-MT-010	KB.RF403.265
	Keyboard CHICONY KG-0766 RF2.4 104KS Silver Hebrew with new color AC-MT-010	KB.RF403.266
	Keyboard CHICONY KG-0766 RF2.4 105KS Silver Slovenian with new color AC-MT-010	KB.RF403.267
	Keyboard CHICONY KG-0766 RF2.4 105KS Silver Slovak with new color AC-MT-010	KB.RF403.268
	Keyboard CHICONY KG-0766 RF2.4 104KS Silver Russian with new color AC-MT-010	KB.RF403.269
	Keyboard CHICONY KG-0766 RF2.4 105KS Silver Hungarian with new color AC-MT-010	KB.RF403.270
	Keyboard CHICONY KG-0766 RF2.4 104KS Silver Greek with new color AC-MT-010	KB.RF403.271
	Keyboard CHICONY KG-0766 RF2.4 105KS Silver Danish with new color AC-MT-010	KB.RF403.272
	Keyboard CHICONY KG-0766 RF2.4 104KS Silver Czech with new color AC-MT-010	KB.RF403.273

CATEGORY	Description	ACER PART NO.
	Keyboard CHICONY KG-0766 RF2.4 105KS Silver Romanian with new color AC-MT-010	KB.RF403.274
	Keyboard CHICONY KG-0766 RF2.4 105KS Silver Turkish with new color AC-MT-010	KB.RF403.275
	Keyboard CHICONY KG-0766 RF2.4 105KS Silver Turkish-Q with new color AC-MT-010	KB.RF403.276
	Keyboard CHICONY KG-0766 RF2.4 105KS Silver Arabic/French with new color AC-MT-010	KB.RF403.277
	Keyboard CHICONY KG-0766 RF2.4 104KS Silver Kazakh with new color AC-MT-010	KB.RF403.278
	Keyboard CHICONY KG-0766 RF2.4 105KS Silver Nordic with new color AC-MT-010	KB.RF403.280
	Keyboard CHICONY KG-0766 RF2.4 105KS Silver Spanish Latin with new color AC-MT-010	KB.RF403.281
	Keyboard CHICONY KG-0766 RF2.4 105KS Silver Polish with new color AC-MT-010	KB.RF403.282
	Keyboard CHICONY KG-0766 RF2.4 104KS Silver Turkmen with new color AC-MT-010	KB.RF403.279
MOUSE		
	Chicony wireless mouse RF2.4 MG-0766 with new color AC-MT-010	MS.11200.063
USB IR Receiver		
	USB IR RECEIVER RG-0618U-995L	
OPTICAL DRIVE		
	ODD SONY Super-Multi DRIVE 12.7mm Slot LabelFlash 8X AD-7643S LF W/O bezel SATA w/ Win7	KU.0080E.029
MAINBOARD		
	MAINBOARD UMA INTEL G45 ICH10 W/O 1394 W/O CPU RAM	MB.G8806.001
	MAINBOARD DIS INTEL G45 ICH11 W/O 1394 W/O CPU RAM	MB.SC906.005

CATEGORY	Description	ACER PART NO.
MEMORY		
	Memory NANYA UNB-DIMM DDRIII 1333 1GB NT1GC64B88A0NF-CG LF 128*8 0.07um	KN.1GB03.032
	Memory SAMSUNG UNB-DIMM DDRIII 1333 1GB M378B2873EH1-CH9 LF 128*8 0.055um	KN.1GB0B.030
	Memory HYNIX UNB-DIMM DDRIII 1333 1GB HMT112U6BFR8C-H9 LF 128*8 0.055um	KN.1GB0G.024
	Memory UNIFOSA UNB-DIMM DDRIII 1333 1GB GU502203EP0200 LF 128*8 0.07um	KN.1GB0H.012
	Memory NANYA UNB-DIMM DDRIII 1333 2GB NT2GC64B88A0NF-CG LF 128*8 0.07um	KN.2GB03.016
	Memory SAMSUNG UNB-DIMM DDRIII 1333 2GB M378B5673EH1-CH9 LF 128*8 0.055um	KN.2GB0B.014
	Memory HYNIX UNB-DIMM DDRIII 1333 2GB HMT125U6BFR8C-H9 LF 128*8 0.055um	KN.2GB0G.015
	Memory UNIFOSA UNB-DIMM DDRIII 1333 2GB GU512303EP0200 LF 128*8 0.07um	KN.2GB0H.006
LCD PANEL w/touch		
	LCD 23 IN. TOUCH MODULE W/CONTROL BOARD - SAMSUNG FHD None Glare LTM230HT01	6K.SCY07.001
	LCD 23 IN. TOUCH MODULE W/CONTROL BOARD - LPL FHD None Glare LM230WF1 TLA3	6K.SCY07.002
POWER SUPPLY		
	PSU DELTA DPS-250AB-53A 250W Active PFC Custom "Open" Frame 100-127V/220-240V, EPA 5.0,	PY.25009.012
	PSU LITE-ON PS-5221-8AB 250W Active PFC Custom "Open" Frame 100-127V/220-240V, EPA 5.0	PY.2500B.005

Screw List

Item	Description	Acer Part No.
SCREW		
	SCREW M2.0*2.5-I(NI)(NYLOK) IRON	86.B0607.002
	SCREW M2.0*4.0-NI(NYLOK)IRON	86.NAS07.017
	SCREW M2.0*6.0-I-NI-NYLOK IRON	86.SCY07.001
	SCREW M2.5*4.0-I(NI)(NYLOK)IRON	86.G8507.002
	SCREW M2.5*6.0-I(NI)(NYLOK)	86.SCY07.002
	SCREW M2.5*8-I(BNI)(NYLOK)IRON	86.SCY07.003
	SCREW M4.0*8.0-T(BNI)(NYLOK) IRON	86.SCY07.004
	SCREW T1.7*4.0-I(BZN)	86.SCY07.005
	SCREW M2.5*4-I (NI,NYLOK) IRON	86.SCY07.006
	SCREW M3.0*5.0-P(BNI)NYLOK IRON	86.G5207.002
	SCREW 6-32UNC*5-B(NYLOK)IRON	86.G8507.007

Model Definition and Configuration

Aspire Z5600/Z5610 Series

Model Name	RO	NS	Country	Acer Part no	Description
AZ5600	EMEA	ACH	Netherlands	PW.SC902.027	AZ5600 EMEA001 W7HP64R04a/PDCE6300/U2GBIII13*2/D750GB7.2KS*1/NSM8XSLFSLLOT/B23/802.11bgn/KB/mouse
AZ5600	EMEA	ACH	Netherlands	PW.SC902.027	AZ5600 EMEA001 W7HP64R04a/PDCE6300/U2GBIII13*2/D750GB7.2KS*1/NSM8XSLFSLLOT/B23/802.11bgn/KB/mouse
AZ5600	AAP	AIL	India	PW.SC902.028	AZ5600 AAP001 W7HP64INW1/PDCE5300/U2GBIII13*1/D320GB7.2KS*1/NSM8XSLFSLLOT/B23/A336-D/802.11bgn/US Win7 WMC/mouse/mouse
AZ5600	AAP	AIL	India	PW.SC902.028	AZ5600 AAP001 W7HP64INW1/PDCE5300/U2GBIII13*1/D320GB7.2KS*1/NSM8XSLFSLLOT/B23/A336-D/802.11bgn/US Win7 WMC/mouse/mouse
AZ5600	AAP	ACS	Singapore	PW.SC902.013	AZ5600 AAP001 W7HP64SGW1/PDCE6500/U2GBIII13*1/D750GB7.2KS*1/NSM8XSLFSLLOT/B23/802.11bgn/bluetooth/KB/mouse
AZ5600	AAP	ACS	Singapore	PW.SC902.013	AZ5600 AAP001 W7HP64SGW1/PDCE6500/U2GBIII13*1/D750GB7.2KS*1/NSM8XSLFSLLOT/B23/802.11bgn/bluetooth/KB/mouse
AZ5600	AAP	ACS	Singapore	PW.SC902.013	AZ5600 AAP001 W7HP64SGW1/PDCE6500/U2GBIII13*1/D750GB7.2KS*1/NSM8XSLFSLLOT/B23/802.11bgn/bluetooth/KB/mouse
AZ5600	PA	AMEX	Mexico	PW.SC902.026	AZ5600 PA001 W7HP64EMMX1/PDCE5300/U2GBIII13*2/D640GB7.2KS*1/NSM8XSLFSLLOT/B23/802.11bgn/mouse/mouse
AZ5600	PA	AAC	USA/ Canada	PW.SC902.022	AZ5600 PA001 W7HP64US4/PDCE5300/U2GBIII13*2/D750GB7.2KS*1/NSM8XSLFSLLOT/B23/802.11bgn/mouse/mouse
AZ5600	TWN	GCTWN	Taiwan	PW.SC902.025	AZ5600 TWN001 W7HP64TWH2/PDCE6300/U2GBIII13*1/D750GB7.2KS*1/NSM8XSLFSLLOT/B23/bluetooth/802.11bgn/mouse/mouse
AZ5600	AAP	ATH	Thailand	PW.SC902.021	AZ5600 AAP001 W7HP64EMTHa01/PDCE6500/U2GBIII13*1/D750GB7.2KS*1/NSM8XSLFSLLOT/B23/802.11bgn/bluetooth/KB/mouse

Model Name	RO	NS	Country	Acer Part no	Description
AZ5600	AAP	ATH	Thailand	PW.SC902.021	AZ5600 AAP001 W7HP64EMTHa01/ PDCE6500/U2GBIII13*1/D750GB7.2KS*1/ NSM8XSLFSL0T/B23/802.11bgn/bluetooth/ KB/mouse
AZ5600	AAP	ATH	Thailand	PW.SC902.021	AZ5600 AAP001 W7HP64EMTHa01/ PDCE6500/U2GBIII13*1/D750GB7.2KS*1/ NSM8XSLFSL0T/B23/802.11bgn/bluetooth/ KB/mouse
AZ5600	AAP	AJC	Japan	PW.SC902.024	AZ5600 AAP001 W7HP64JAHP2/C2DE7600/ U1GBIII13*2/D750GB7.2KS*1/ NSM8XSLFSL0T/B23/802.11bgn/bluetooth/ KB/mouse
AZ5600	CHINA	ACCN	China	PW.SC902.020	AZ5600 CHINA001 W7HP64SCCNa01/ PDCE5400/U2GBIII13*1/D750GB7.2KS*1/ NSM8XSLFSL0T/B23/802.11bgn/bluetooth/ mouse/mouse
AZ5600	AAP	AVN	Vietnam	PW.SC902.019	AZ5600 AAP001 W7HP64EMVNa01/ PDCE5400/U2GBIII13*1/D750GB7.2KS*1/ NSM8XSLFSL0T/B23/802.11bgn/bluetooth/ mouse/mouse
AZ5600	AAP	AVN	Vietnam	PW.SC902.019	AZ5600 AAP001 W7HP64EMVNa01/ PDCE5400/U2GBIII13*1/D750GB7.2KS*1/ NSM8XSLFSL0T/B23/802.11bgn/bluetooth/ mouse/mouse
AZ5600	AAP	AVN	Vietnam	PW.SC902.019	AZ5600 AAP001 W7HP64EMVNa01/ PDCE5400/U2GBIII13*1/D750GB7.2KS*1/ NSM8XSLFSL0T/B23/802.11bgn/bluetooth/ mouse/mouse
AZ5600	AAP	ATH	Thailand	PW.SC902.018	AZ5600 AAP001 W7HP64EMTHa01/ PDCE5400/U2GBIII13*1/D750GB7.2KS*1/ NSM8XSLFSL0T/B23/802.11bgn/bluetooth/ mouse/mouse
AZ5600	AAP	ATH	Thailand	PW.SC902.018	AZ5600 AAP001 W7HP64EMTHa01/ PDCE5400/U2GBIII13*1/D750GB7.2KS*1/ NSM8XSLFSL0T/B23/802.11bgn/bluetooth/ mouse/mouse
AZ5600	AAP	ATH	Thailand	PW.SC902.018	AZ5600 AAP001 W7HP64EMTHa01/ PDCE5400/U2GBIII13*1/D750GB7.2KS*1/ NSM8XSLFSL0T/B23/802.11bgn/bluetooth/ mouse/mouse
AZ5600	AAP	ASSSB	Malaysia	PW.SC902.017	AZ5600 AAP001 W7HP64EMMY1/ PDCE5400/U2GBIII13*1/D750GB7.2KS*1/ NSM8XSLFSL0T/B23/802.11bgn/bluetooth/ mouse/mouse
AZ5600	AAP	ASSSB	Malaysia	PW.SC902.017	AZ5600 AAP001 W7HP64EMMY1/ PDCE5400/U2GBIII13*1/D750GB7.2KS*1/ NSM8XSLFSL0T/B23/802.11bgn/bluetooth/ mouse/mouse
AZ5600	AAP	ASSSB	Malaysia	PW.SC902.017	AZ5600 AAP001 W7HP64EMMY1/ PDCE5400/U2GBIII13*1/D750GB7.2KS*1/ NSM8XSLFSL0T/B23/802.11bgn/bluetooth/ mouse/mouse

Model Name	RO	NS	Country	Acer Part no	Description
AZ5600	AAP	APHI	Philippines	PW.SC902.016	AZ5600 AAP001 W7HP64EMPH5/PDCE5400/ U2GBIII13*1/D750GB7.2KS*1/ NSM8XSLFSL0T/B23/802.11bgn/bluetooth/ mouse/mouse
AZ5600	AAP	APHI	Philippines	PW.SC902.016	AZ5600 AAP001 W7HP64EMPH5/PDCE5400/ U2GBIII13*1/D750GB7.2KS*1/ NSM8XSLFSL0T/B23/802.11bgn/bluetooth/ mouse/mouse
AZ5600	AAP	APHI	Philippines	PW.SC902.016	AZ5600 AAP001 W7HP64EMPH5/PDCE5400/ U2GBIII13*1/D750GB7.2KS*1/ NSM8XSLFSL0T/B23/802.11bgn/bluetooth/ mouse/mouse
AZ5600	AAP	AIN	Indonesia	PW.SC902.015	AZ5600 AAP001 W7HP64EMID1/PDCE5400/ U2GBIII13*1/D750GB7.2KS*1/ NSM8XSLFSL0T/B23/802.11bgn/bluetooth/ mouse/mouse
AZ5600	AAP	AIN	Indonesia	PW.SC902.015	AZ5600 AAP001 W7HP64EMID1/PDCE5400/ U2GBIII13*1/D750GB7.2KS*1/ NSM8XSLFSL0T/B23/802.11bgn/bluetooth/ mouse/mouse
AZ5600	AAP	AIN	Indonesia	PW.SC902.015	AZ5600 AAP001 W7HP64EMID1/PDCE5400/ U2GBIII13*1/D750GB7.2KS*1/ NSM8XSLFSL0T/B23/802.11bgn/bluetooth/ mouse/mouse
AZ5600	AAP	AIL	India	PW.SC902.014	AZ5600 AAP001 W7HP64INW1/PDCE5400/ U2GBIII13*1/D750GB7.2KS*1/ NSM8XSLFSL0T/B23/802.11bgn/bluetooth/ mouse/mouse
AZ5600	AAP	AIL	India	PW.SC902.014	AZ5600 AAP001 W7HP64INW1/PDCE5400/ U2GBIII13*1/D750GB7.2KS*1/ NSM8XSLFSL0T/B23/802.11bgn/bluetooth/ mouse/mouse
AZ5600	AAP	AIL	India	PW.SC902.014	AZ5600 AAP001 W7HP64INW1/PDCE5400/ U2GBIII13*1/D750GB7.2KS*1/ NSM8XSLFSL0T/B23/802.11bgn/bluetooth/ mouse/mouse
AZ5600	AAP	ACA	Australia/ New Zealand	PW.SC902.012	AZ5600 AAP001 W7HP64AUHP5/PDCE5400/ U2GBIII13*1/D750GB7.2KS*1/ NSM8XSLFSL0T/B23/802.11bgn/bluetooth/ mouse/mouse
AZ5600	AAP	ACA	Australia/ New Zealand	PW.SC902.012	AZ5600 AAP001 W7HP64AUHP5/PDCE5400/ U2GBIII13*1/D750GB7.2KS*1/ NSM8XSLFSL0T/B23/802.11bgn/bluetooth/ mouse/mouse
AZ5600	AAP	ACA	Australia/ New Zealand	PW.SC902.012	AZ5600 AAP001 W7HP64AUHP5/PDCE5400/ U2GBIII13*1/D750GB7.2KS*1/ NSM8XSLFSL0T/B23/802.11bgn/bluetooth/ mouse/mouse
AZ5600	AAP	ACA	Australia/ New Zealand	PW.SC902.011	AZ5600 AAP001 W7HP64AUHP5/ C2QQ8200s/U2GBIII13*2/D750GB7.2KS*1/ NSM8XSLFSL0T/B23/802.11bgn/bluetooth/ mouse/mouse

Model Name	RO	NS	Country	Acer Part no	Description
AZ5600	AAP	ACA	Australia/ New Zealand	PW.SC902.011	AZ5600 AAP001 W7HP64AUHP5/ C2QQ8200s/U2GBIII13*2/D750GB7.2KS*1/ NSM8XSLFSL0T/B23/802.11bgn/bluetooth/ mouse/mouse
AZ5600	AAP	ACA	Australia/ New Zealand	PW.SC902.011	AZ5600 AAP001 W7HP64AUHP5/ C2QQ8200s/U2GBIII13*2/D750GB7.2KS*1/ NSM8XSLFSL0T/B23/802.11bgn/bluetooth/ mouse/mouse
AZ5600	TWN	GCTWN	Taiwan	PW.SC902.009	AZ5600 TWN001 W7HP64TWHP2/ PDCE5400/U2GBIII13*1/D640GB7.2KS*1/ NSM8XSLFSL0T/B23/bluetooth/802.11bgn/ mouse/mouse
AZ5600	PA	AAC	USA/ Canada	S1.SC902.004	AZ5600 Sample PA001 W7HP64US1/ C2QQ9400s/U2GBIII13*4/D1000GB7.2KS*1/ B23/HD4650/Hybrid/SW/802.11bgn/US RC/ USB/0811/USB/0811
AZ5600	EMEA	AUK	UK	S1.SC902.003	AZ5600 Sample EMEA001 W7HP64UK02/ PDCE5400/U2GBIII13*1/D640GB7.2KS*1/ B23/Hybrid/SW/802.11bgn/EMEA RC/USB/ 0811/USB/0811
AZ5600	EMEA	AUK	UK	S1.SC902.003	AZ5600 Sample EMEA001 W7HP64UK02/ PDCE5400/U2GBIII13*1/D640GB7.2KS*1/ B23/Hybrid/SW/802.11bgn/EMEA RC/USB/ 0811/USB/0811
AZ5600	EMEA	AUK	UK	S1.SC902.003	AZ5600 Sample EMEA001 W7HP64UK02/ PDCE5400/U2GBIII13*1/D640GB7.2KS*1/ B23/Hybrid/SW/802.11bgn/EMEA RC/USB/ 0811/USB/0811
AZ5600	PA	AAC	USA/ Canada	S1.SC902.002	AZ5600 Sample PA001 W7HP64US1/ C2QQ8200s/U2GBIII13*4/D750GB7.2KS*1/ HD4530/Hybrid/SW/802.11bgn/USB/0811/ USB/0811
AZ5600	PA	AAC	USA/ Canada	S1.SC902.001	AZ5600 Sample PA001 W7HP64US1/ C2DE8400/U2GBIII13*4/D750GB7.2KS*1/ HD4530/Hybrid/SW/802.11bgn/USB/0811/ USB/0811
AZ5610	EMEA	AIB	Spain	PW.SCY02.068	AZ5610 EMEA001 W7HP64R11a/ C2QQ8200s/U2GBIII13*4/D1500GB7.2KS*1/ NSM8XSLFSL0T/B23/vga/A336-D/ 802.11bgn/bluetooth/EMEA Win7 WMC/ mouse/mouse
AZ5610	EMEA	AUA	Ukraine	PW.SCY02.022	AZ5610 EMEA001 W7HP64RUR31a/ C2DE7500/U2GBIII13*2/D1000GB7.2KS*1/ NSM8XSLFSL0T/B23/HD4570/A336-D/ 802.11bgn/bluetooth/EMEA Win7 WMC/KB/ mouse
AZ5610	EMEA	AUK	UK	PW.SCY02.019	AZ5610 EMEA001 W7HP64R16a/C2DE7500/ U2GBIII13*2/D1000GB7.2KS*1/ NSM8XSLFSL0T/B23/HD4570/A336-D/ 802.11bgn/bluetooth/EMEA Win7 WMC/KB/ mouse

Model Name	RO	NS	Country	Acer Part no	Description
AZ5610	EMEA	AUK	UK	PW.SCY02.019	AZ5610 EMEA001 W7HP64R16a/C2DE7500/ U2GBIII13*2/D1000GB7.2KS*1/ NSM8XSLFSLLOT/B23/HD4570/A336-D/ 802.11bgn/bluetooth/EMEA Win7 WMC/KB/ mouse
AZ5610	EMEA	AUK	UK	PW.SCY02.023	AZ5610 EMEA001 W7HP64R16a/C2DE7500/ U2GBIII13*2/D640GB7.2KS*1/ NSM8XSLFSLLOT/B23/HD4570/A336-D/ 802.11bgn/bluetooth/EMEA Win7 WMC/KB/ mouse
AZ5610	EMEA	AUK	UK	PW.SCY02.023	AZ5610 EMEA001 W7HP64R16a/C2DE7500/ U2GBIII13*2/D640GB7.2KS*1/ NSM8XSLFSLLOT/B23/HD4570/A336-D/ 802.11bgn/bluetooth/EMEA Win7 WMC/KB/ mouse
AZ5610	EMEA	ACG	Germany	PW.SCY02.017	AZ5610 EMEA001 W7HP64R03a/C2DE7500/ U2GBIII13*2/D750GB7.2KS*1/ NSM8XSLFSLLOT/B23/HD4570/A336-D/ 802.11bgn/bluetooth/EMEA Win7 WMC/KB/ mouse
AZ5610	EMEA	ACG	Germany	PW.SCY02.017	AZ5610 EMEA001 W7HP64R03a/C2DE7500/ U2GBIII13*2/D750GB7.2KS*1/ NSM8XSLFSLLOT/B23/HD4570/A336-D/ 802.11bgn/bluetooth/EMEA Win7 WMC/KB/ mouse
AZ5610	EMEA	AUK	UK	PW.SCY02.019	AZ5610 EMEA001 W7HP64R16a/C2DE7500/ U2GBIII13*2/D1000GB7.2KS*1/ NSM8XSLFSLLOT/B23/HD4570/A336-D/ 802.11bgn/bluetooth/EMEA Win7 WMC/KB/ mouse
AZ5610	EMEA	AUK	UK	PW.SCY02.023	AZ5610 EMEA001 W7HP64R16a/C2DE7500/ U2GBIII13*2/D640GB7.2KS*1/ NSM8XSLFSLLOT/B23/HD4570/A336-D/ 802.11bgn/bluetooth/EMEA Win7 WMC/KB/ mouse
AZ5610	EMEA	ACR	Russia	PW.SCY02.067	AZ5610 EMEA001 W7HP64RUR15a01/ C2QQ8200s/U2GBIII13*2/D640GB7.2KS*1/ NSM8XSLFSLLOT/B23/vga/A336-D/ 802.11bgn/bluetooth/EMEA Win7 WMC/ mouse/mouse
AZ5610	EMEA	ACR	Russia	PW.SCY02.066	AZ5610 EMEA001 W7HP64RUR15a01/ PDCE5300/U2GBIII13*1/D320GB7.2KS*1/ NSM8XSLFSLLOT/B23/HD4570/802.11bgn/ bluetooth/mouse/mouse
AZ5610	EMEA	AME	Africa/North Africa	PW.SCY02.065	AZ5610 EMEA001 W7HP64EMR24a/ C2QQ9400s/U2GBIII13*2/D1000GB7.2KS*1/ NSM8XSLFSLLOT/B23/vga/A336-D/ 802.11bgn/bluetooth/EMEA Win7 WMC/ mouse/mouse
AZ5610	EMEA	AME	Africa/North Africa	PW.SCY02.064	AZ5610 EMEA001 W7HP64EMR24a/ C2QQ8200s/U2GBIII13*2/D750GB7.2KS*1/ NSM8XSLFSLLOT/B23/HD4570/A336-D/ 802.11bgn/bluetooth/EMEA Win7 WMC/ mouse/mouse

Model Name	RO	NS	Country	Acer Part no	Description
AZ5610	EMEA	AIB	Spain	PW.SCY02.063	AZ5610 EMEA001 W7HP64R11a/ C2QQ8200s/U2GBIII13*4/D1500GB7.2KS*1/ NSM8XSLFSLOT/B23/vga/802.11bgn/ bluetooth/mouse/mouse
AZ5610	EMEA	AUK	UK	PW.SCY02.024	AZ5610 EMEA001 W7HP64R16a/ C2QQ8200s/U2GBIII13*2/D1000GB7.2KS*1/ NSM8XSLFSLOT/B23/HD4570/A336-D/ 802.11bgn/bluetooth/EMEA Win7 WMC/KB/ mouse
AZ5610	EMEA	AUK	UK	PW.SCY02.024	AZ5610 EMEA001 W7HP64R16a/ C2QQ8200s/U2GBIII13*2/D1000GB7.2KS*1/ NSM8XSLFSLOT/B23/HD4570/A336-D/ 802.11bgn/bluetooth/EMEA Win7 WMC/KB/ mouse
AZ5610	EMEA	AUK	UK	PW.SCY02.024	AZ5610 EMEA001 W7HP64R16a/ C2QQ8200s/U2GBIII13*2/D1000GB7.2KS*1/ NSM8XSLFSLOT/B23/HD4570/A336-D/ 802.11bgn/bluetooth/EMEA Win7 WMC/KB/ mouse
AZ5610	EMEA	AUA	Ukraine	PW.SCY02.025	AZ5610 EMEA001 W7HP64RUR31a/ C2QQ8200s/U2GBIII13*2/D1500GB7.2KS*1/ NSM8XSLFSLOT/B23/HD4570/A336-D/ 802.11bgn/bluetooth/EMEA Win7 WMC/KB/ mouse
AZ5610	EMEA	AUA	Ukraine	PW.SCY02.026	AZ5610 EMEA001 W7HP64RUR31a/ C2QQ9400s/U2GBIII13*4/D1500GB7.2KS*1/ NSM8XSLFSLOT/B23/HD4570/A336-D/ 802.11bgn/bluetooth/EMEA Win7 WMC/KB/ mouse
AZ5610	EMEA	AUK	UK	PW.SCY02.034	AZ5610 EMEA001 W7HP64R16a/C2DE7500/ U2GBIII13*2/D750GB7.2KS*1/ NSM8XSLFSLOT/B23/HD4570/A336-D/ 802.11bgn/bluetooth/EMEA Win7 WMC/KB/ mouse
AZ5610	EMEA	AUK	UK	PW.SCY02.034	AZ5610 EMEA001 W7HP64R16a/C2DE7500/ U2GBIII13*2/D750GB7.2KS*1/ NSM8XSLFSLOT/B23/HD4570/A336-D/ 802.11bgn/bluetooth/EMEA Win7 WMC/KB/ mouse
AZ5610	EMEA	AUK	UK	PW.SCY02.034	AZ5610 EMEA001 W7HP64R16a/C2DE7500/ U2GBIII13*2/D750GB7.2KS*1/ NSM8XSLFSLOT/B23/HD4570/A336-D/ 802.11bgn/bluetooth/EMEA Win7 WMC/KB/ mouse
AZ5610	EMEA	ACG	Germany	PW.SCY02.033	AZ5610 EMEA001 W7HP64R03a/ C2QQ9400s/U2GBIII13*4/ D1000GB7.2KS*1+SSD2564*1/ NSM8XSLFSLOT/B23/HD4570/A336-D/ 802.11bgn/bluetooth/EMEA Win7 WMC/KB/ mouse

Model Name	RO	NS	Country	Acer Part no	Description
AZ5610	EMEA	ACG	Germany	PW.SCY02.033	AZ5610 EMEA001 W7HP64R03a/ C2QQ9400s/U2GBIII13*4/ D1000GB7.2KS*1+SSD2564*1/ NSM8XSLFSL0T/B23/HD4570/A336-D/ 802.11bgn/bluetooth/EMEA Win7 WMC/KB/ mouse
AZ5610	EMEA	ARN	Nordic	PW.SCY02.062	AZ5610 EMEA001 W7HP64R32a/ C2QQ8200s/U2GBIII13*2/D1000GB7.2KS*1/ NSM8XSLFSL0T/B23/HD4570/802.11bgn/ bluetooth/EMEA Win7 WMC/mouse/mouse
AZ5610	EMEA	ACR	Russia	PW.SCY02.061	AZ5610 EMEA001 W7HP64RUR15a01/ C2QQ8200s/U2GBIII13*2/D1000GB7.2KS*1/ NBDCB4XSSL0T/B23/vga/A336-D/ 802.11bgn/bluetooth/EMEA Win7 WMC/ mouse/mouse
AZ5610	EMEA	AIB	Spain	PW.SCY02.036	AZ5610 EMEA001 W7HP64R11a/PDCE5300/ U2GBIII13*2/D750GB7.2KS*1/ NSM8XSLFSL0T/B23/HD4570/A336-D/ 802.11bgn/bluetooth/EMEA Win7 WMC/KB/ mouse
AZ5610	EMEA	AIB	Spain	PW.SCY02.036	AZ5610 EMEA001 W7HP64R11a/PDCE5300/ U2GBIII13*2/D750GB7.2KS*1/ NSM8XSLFSL0T/B23/HD4570/A336-D/ 802.11bgn/bluetooth/EMEA Win7 WMC/KB/ mouse
AZ5610	EMEA	AME	Saudi/ Levant/ Egypt	PW.SCY02.037	AZ5610 EMEA001 W7HP64EMR22a/ C2QQ8200s/U2GBIII13*2/D750GB7.2KS*1/ NSM8XSLFSL0T/B23/HD4570/A336-D/ 802.11bgn/bluetooth/EMEA Win7 WMC/KB/ mouse
AZ5610	EMEA	AIT	Italy	PW.SCY02.005	AZ5610 EMEA001 W7HP64R13a/ C2QQ8200s/U2GBIII13*2/D750GB7.2KS*1/ NSM8XSLFSL0T/B23/HD4570/A336-D/ 802.11bgn/bluetooth/EMEA Win7 WMC/KB/ mouse
AZ5610	EMEA	ACG	Germany	PW.SCY02.040	AZ5610 EMEA001 W7HP64R03a/ C2QQ8200s/U2GBIII13*2/D1000GB7.2KS*1/ NSM8XSLFSL0T/B23/HD4570/A336-D/ 802.11bgn/bluetooth/EMEA Win7 WMC/KB/ mouse
AZ5610	EMEA	ACG	Germany	PW.SCY02.040	AZ5610 EMEA001 W7HP64R03a/ C2QQ8200s/U2GBIII13*2/D1000GB7.2KS*1/ NSM8XSLFSL0T/B23/HD4570/A336-D/ 802.11bgn/bluetooth/EMEA Win7 WMC/KB/ mouse
AZ5610	EMEA	ACH	Netherlands	PW.SCY02.041	AZ5610 EMEA001 W7HP64R04a/ C2QQ8200s/U2GBIII13*2/D1000GB7.2KS*1/ NBDCB4XSSL0T/B23/vga/A336-D/ 802.11bgn/bluetooth/EMEA Win7 WMC/KB/ mouse

Model Name	RO	NS	Country	Acer Part no	Description
AZ5610	EMEA	ACH	Netherlands	PW.SCY02.041	AZ5610 EMEA001 W7HP64R04a/ C2QQ8200s/U2GBIII13*2/D1000GB7.2KS*1/ NBDCB4XSSLOT/B23/vga/A336-D/ 802.11bgn/bluetooth/EMEA Win7 WMC/KB/ mouse
AZ5610	EMEA	ACR	Russia	PW.SCY02.046	AZ5610 EMEA001 W7HP64RUR15a/ C2QQ8200s/U2GBIII13*2/D1000GB7.2KS*1/ NSM8XSLFSLLOT/B23/vga/A336-D/ 802.11bgn/bluetooth/EMEA Win7 WMC/KB/ mouse
AZ5610	EMEA	ASZ	Switzerland	PW.SCY02.047	AZ5610 EMEA001 W7HP64R10a/ C2QQ9400s/U2GBIII13*4/D1000GB7.2KS*1/ NBDCB4XSSLOT/B23/HD4570/A336-D/ 802.11bgn/bluetooth/EMEA Win7 WMC/KB/ mouse
AZ5610	EMEA	ACH	Belgium	PW.SCY02.048	AZ5610 EMEA001 W7HP64R05a/ C2QQ8200s/U2GBIII13*2/D1000GB7.2KS*1/ NBDCB4XSSLOT/B23/vga/A336-D/ 802.11bgn/bluetooth/EMEA Win7 WMC/KB/ mouse
AZ5610	EMEA	ACH	Belgium	PW.SCY02.048	AZ5610 EMEA001 W7HP64R05a/ C2QQ8200s/U2GBIII13*2/D1000GB7.2KS*1/ NBDCB4XSSLOT/B23/vga/A336-D/ 802.11bgn/bluetooth/EMEA Win7 WMC/KB/ mouse
AZ5610	EMEA	ACH	Luxembourg	PW.SCY02.049	AZ5610 EMEA001 W7HP64R06a/ C2QQ8200s/U2GBIII13*2/D1000GB7.2KS*1/ NBDCB4XSSLOT/B23/vga/A336-D/ 802.11bgn/bluetooth/EMEA Win7 WMC/KB/ mouse
AZ5610	EMEA	ACH	Luxembourg	PW.SCY02.049	AZ5610 EMEA001 W7HP64R06a/ C2QQ8200s/U2GBIII13*2/D1000GB7.2KS*1/ NBDCB4XSSLOT/B23/vga/A336-D/ 802.11bgn/bluetooth/EMEA Win7 WMC/KB/ mouse
AZ5610	EMEA	AME	Saudi/ Levant/ Egypt	PW.SCY02.051	AZ5610 EMEA001 W7HP64EMR22a01/ C2DE7500/U2GBIII13*2/D750GB7.2KS*1/ NSM8XSLFSLLOT/B23/HD4570/A336-D/ 802.11bgn/bluetooth/EMEA Win7 WMC/KB/ mouse
AZ5610	EMEA	ASZ	Switzerland	PW.SCY02.052	AZ5610 EMEA001 W7HP64R10a/C2DE7500/ U2GBIII13*2/D750GB7.2KS*1/ NSM8XSLFSLLOT/B23/HD4570/A336-D/ 802.11bgn/bluetooth/EMEA Win7 WMC/KB/ mouse
AZ5610	EMEA	AEE	Bulgaria/ Latvia/ Lithuania/ Estonia	PW.SCY02.042	AZ5610 EMEA001 W7HP64R33a/ C2QQ8200s/U2GBIII13*2/D1000GB7.2KS*1/ NSM8XSLFSLLOT/B23/HD4570/A336-D/ 802.11bgn/bluetooth/EMEA Win7 WMC/KB/ mouse/A.

Model Name	RO	NS	Country	Acer Part no	Description
AZ5610	EMEA	AEE	Bulgaria/ Latvia/ Lithuania/ Estonia	PW.SCY02.042	AZ5610 EMEA001 W7HP64R33a/ C2QQ8200s/U2GBIII13*2/D1000GB7.2KS*1/ NSM8XSLFSL0T/B23/HD4570/A336-D/ 802.11bgn/bluetooth/EMEA Win7 WMC/KB/ mouse/A.
AZ5610	EMEA	AEE	Bulgaria/ Latvia/ Lithuania/ Estonia	PW.SCY02.043	AZ5610 EMEA001 W7HP64R33a/ C2QQ9400s/U2GBIII13*2/D1000GB7.2KS*1/ NSM8XSLFSL0T/B23/HD4570/A336-D/ 802.11bgn/bluetooth/EMEA Win7 WMC/KB/ mouse/A.
AZ5610	EMEA	AEE	Bulgaria/ Latvia/ Lithuania/ Estonia	PW.SCY02.043	AZ5610 EMEA001 W7HP64R33a/ C2QQ9400s/U2GBIII13*2/D1000GB7.2KS*1/ NSM8XSLFSL0T/B23/HD4570/A336-D/ 802.11bgn/bluetooth/EMEA Win7 WMC/KB/ mouse/A.
AZ5610	EMEA	AEE	Bulgaria/ Latvia/ Lithuania/ Estonia	PW.SCY02.053	AZ5610 EMEA001 W7HP64R33a/ C2QQ8200s/U2GBIII13*2/D1000GB7.2KS*1/ NSM8XSLFSL0T/B23/HD4570/A336-D/ 802.11bgn/bluetooth/EMEA Win7 WMC/KB/ mouse
AZ5610	EMEA	AEE	Bulgaria/ Latvia/ Lithuania/ Estonia	PW.SCY02.053	AZ5610 EMEA001 W7HP64R33a/ C2QQ8200s/U2GBIII13*2/D1000GB7.2KS*1/ NSM8XSLFSL0T/B23/HD4570/A336-D/ 802.11bgn/bluetooth/EMEA Win7 WMC/KB/ mouse
AZ5610	EMEA	AEE	Bulgaria/ Latvia/ Lithuania/ Estonia	PW.SCY02.054	AZ5610 EMEA001 W7HP64R33a/ C2QQ9400s/U2GBIII13*2/D1000GB7.2KS*1/ NSM8XSLFSL0T/B23/HD4570/A336-D/ 802.11bgn/bluetooth/EMEA Win7 WMC/KB/ mouse
AZ5610	EMEA	AEE	Bulgaria/ Latvia/ Lithuania/ Estonia	PW.SCY02.054	AZ5610 EMEA001 W7HP64R33a/ C2QQ9400s/U2GBIII13*2/D1000GB7.2KS*1/ NSM8XSLFSL0T/B23/HD4570/A336-D/ 802.11bgn/bluetooth/EMEA Win7 WMC/KB/ mouse
AZ5610	EMEA	ACZ	Czech Republic	PW.SCY02.055	AZ5610 EMEA001 W7HP64R19a/ C2QQ8200s/U2GBIII13*2/D1000GB7.2KS*1/ NSM8XSLFSL0T/B23/vga/A336-D/ 802.11bgn/bluetooth/EMEA Win7 WMC/KB/ mouse
AZ5610	EMEA	AIT	Italy	PW.SCY02.056	AZ5610 EMEA001 W7HP64R13a/ C2QQ8200s/U2GBIII13*4/D1000GB7.2KS*1/ NBDCB4XSSL0T/B23/vga/A336-D/ 802.11bgn/bluetooth/EMEA Win7 WMC/KB/ mouse
AZ5610	EMEA	AIT	Italy	PW.SCY02.058	AZ5610 EMEA001 W7HP64R13a/PDCE6300/ U2GBIII13*2/D640GB7.2KS*1/ NSM8XSLFSL0T/B23/HD4570/A336-D/ 802.11bgn/bluetooth/EMEA Win7 WMC/KB/ mouse
AZ5610	EMEA	ACF	France	PW.SCY02.060	AZ5610 EMEA001 W7HP64R02a01/ C2DE7500/U2GBIII13*4/D1000GB7.2KS*1/ NSM8XSLFSL0T/B23/vga/802.11bgn/ bluetooth/mouse/mouse

Model Name	RO	NS	Country	Acer Part no	Description
AZ5610	EMEA	ACR	Russia	PW.SCY02.059	AZ5610 EMEA001 W7HP64RUR15a01/ C2DE7500/U2GBIII13*2/D750GB7.2KS*1/ NBDCB4XSSLOT/B23/HD4570/802.11bgn/ bluetooth/mouse/mouse
AZ5610	EMEA	ACH	Belgium	PW.SCY02.057	AZ5610 EMEA001 W7HP64R05a/C2DE7500/ U2GBIII13*2/D500GB7.2KS*1/ NSM8XSLFSLLOT/B23/HD4570/802.11bgn/ bluetooth/mouse/mouse
AZ5610	EMEA	ACH	Belgium	PW.SCY02.057	AZ5610 EMEA001 W7HP64R05a/C2DE7500/ U2GBIII13*2/D500GB7.2KS*1/ NSM8XSLFSLLOT/B23/HD4570/802.11bgn/ bluetooth/mouse/mouse
AZ5610	AAP	ACS	Singapore	PW.SCY02.007	AZ5610 AAP001 W7HP64SGW1/ C2QQ8200s/U2GBIII13*2/D1000GB7.2KS*1/ NSM8XSLFSLLOT/B23/HD4570/A336-D/ 802.11bgn/bluetooth/US Win7 WMC/KB/ mouse
AZ5610	AAP	ACS	Singapore	PW.SCY02.007	AZ5610 AAP001 W7HP64SGW1/ C2QQ8200s/U2GBIII13*2/D1000GB7.2KS*1/ NSM8XSLFSLLOT/B23/HD4570/A336-D/ 802.11bgn/bluetooth/US Win7 WMC/KB/ mouse
AZ5610	AAP	ACS	Singapore	PW.SCY02.007	AZ5610 AAP001 W7HP64SGW1/ C2QQ8200s/U2GBIII13*2/D1000GB7.2KS*1/ NSM8XSLFSLLOT/B23/HD4570/A336-D/ 802.11bgn/bluetooth/US Win7 WMC/KB/ mouse
AZ5610	EMEA	ACR	Russia	PW.SCY02.050	AZ5610 EMEA001 W7HP64RUR15a/ C2QQ8200s/U2GBIII13*2/D1000GB7.2KS*1/ NSM8XSLFSLLOT/B23/vga/802.11bgn/ bluetooth/mouse/mouse
AZ5610	EMEA	ACR	Russia	PW.SCY02.045	AZ5610 EMEA001 W7HP64RUR15a/ PDCE6300/U1GBIII13*1+U2GBIII13*1/ D500GB7.2KS*1/NSM8XSLFSLLOT/B23/ HD4570/802.11bgn/bluetooth/mouse/mouse
AZ5610	AAP	AIN	Indonesia	PW.SCY02.044	AZ5610 AAP001 W7HP64EMID1/ C2QQ8400s/U2GBIII13*2/D750GB7.2KS*1/ NSM8XSLFSLLOT/B23/HD4570/802.11bgn/ bluetooth/mouse/mouse
AZ5610	AAP	AIN	Indonesia	PW.SCY02.044	AZ5610 AAP001 W7HP64EMID1/ C2QQ8400s/U2GBIII13*2/D750GB7.2KS*1/ NSM8XSLFSLLOT/B23/HD4570/802.11bgn/ bluetooth/mouse/mouse
AZ5610	EMEA	ACF	France	PW.SCY02.039	AZ5610 EMEA001 W7HP64R02a/PDCE5300/ U2GBIII13*2/D750GB7.2KS*1/ NSM8XSLFSLLOT/B23/HD4570/802.11bgn/ bluetooth/mouse/mouse
AZ5610	EMEA	ACF	France	PW.SCY02.039	AZ5610 EMEA001 W7HP64R02a/PDCE5300/ U2GBIII13*2/D750GB7.2KS*1/ NSM8XSLFSLLOT/B23/HD4570/802.11bgn/ bluetooth/mouse/mouse

Model Name	RO	NS	Country	Acer Part no	Description
AZ5610	EMEA	AME	Saudi/ Levant/ Egypt	PW.SCY02.038	AZ5610 EMEA001 W7HP64EMR22a/ C2DE7500/U2GBIII13*2/D750GB7.2KS*1/ NSM8XSLFSL0T/B23/HD4570/802.11bgn/ bluetooth/mouse/mouse
AZ5610	AAP	APHI	Philippines	PW.SCY02.035	AZ5610 AAP001 W7HP64EMPH5/C2DE7500/ U1GBIII13*1+U2GBIII13*1/D750GB7.2KS*1/ NSM8XSLFSL0T/B23/HD4570/A336-D/ 802.11bgn/bluetooth/KB/mouse
AZ5610	AAP	APHI	Philippines	PW.SCY02.035	AZ5610 AAP001 W7HP64EMPH5/C2DE7500/ U1GBIII13*1+U2GBIII13*1/D750GB7.2KS*1/ NSM8XSLFSL0T/B23/HD4570/A336-D/ 802.11bgn/bluetooth/KB/mouse
AZ5610	AAP	APHI	Philippines	PW.SCY02.035	AZ5610 AAP001 W7HP64EMPH5/C2DE7500/ U1GBIII13*1+U2GBIII13*1/D750GB7.2KS*1/ NSM8XSLFSL0T/B23/HD4570/A336-D/ 802.11bgn/bluetooth/KB/mouse
AZ5610	PA	AAC	USA/ Canada	PW.SCY02.032	AZ5610 PA001 W7HP64US1/PDCE5300/ U2GBIII13*2/D320GB7.2KS*1/ NSM8XSLFSL0T/B23/HD4570/802.11bgn/ KB/mouse
AZ5610	AAP	AJC	Japan	PW.SCY02.031	AZ5610 AAP001 W7HP64JAHP2/ C2QQ9400s/U2GBIII13*2/D1000GB7.2KS*1/ NSM8XSLFSL0T/B23/HD4570/A325/ 802.11bgn/bluetooth/Japan Win7 WMC/KB/ mouse/consigned B-CAS CARD
AZ5610	AAP	ATH	Thailand	PW.SCY02.030	AZ5610 AAP001 W7HP64EMTHa01/ C2QQ8400s/U2GBIII13*2/D1000GB7.2KS*1/ NSM8XSLFSL0T/B23/HD4570/802.11bgn/ bluetooth/mouse/mouse
AZ5610	AAP	ATH	Thailand	PW.SCY02.030	AZ5610 AAP001 W7HP64EMTHa01/ C2QQ8400s/U2GBIII13*2/D1000GB7.2KS*1/ NSM8XSLFSL0T/B23/HD4570/802.11bgn/ bluetooth/mouse/mouse
AZ5610	AAP	ATH	Thailand	PW.SCY02.030	AZ5610 AAP001 W7HP64EMTHa01/ C2QQ8400s/U2GBIII13*2/D1000GB7.2KS*1/ NSM8XSLFSL0T/B23/HD4570/802.11bgn/ bluetooth/mouse/mouse
AZ5610	AAP	ATH	Thailand	PW.SCY02.029	AZ5610 AAP001 W7HP64EMTHa01/ C2QQ9400s/U2GBIII13*2/D1000GB7.2KS*1/ NSM8XSLFSL0T/B23/HD4570/802.11bgn/ bluetooth/mouse/mouse
AZ5610	AAP	ATH	Thailand	PW.SCY02.029	AZ5610 AAP001 W7HP64EMTHa01/ C2QQ9400s/U2GBIII13*2/D1000GB7.2KS*1/ NSM8XSLFSL0T/B23/HD4570/802.11bgn/ bluetooth/mouse/mouse
AZ5610	AAP	ATH	Thailand	PW.SCY02.029	AZ5610 AAP001 W7HP64EMTHa01/ C2QQ9400s/U2GBIII13*2/D1000GB7.2KS*1/ NSM8XSLFSL0T/B23/HD4570/802.11bgn/ bluetooth/mouse/mouse

Model Name	RO	NS	Country	Acer Part no	Description
AZ5610	AAP	ACA	Australia/ New Zealand	PW.SCY02.028	AZ5610 AAP001 W7HP64AUHP5/C2DE7500/ U2GBIII13*2/D750GB7.2KS*1/ NSM8XSLFSLLOT/B23/HD4570/A336-D/ 802.11bgn/bluetooth/US Win7 WMC/mouse/ mouse
AZ5610	AAP	ACA	Australia/ New Zealand	PW.SCY02.028	AZ5610 AAP001 W7HP64AUHP5/C2DE7500/ U2GBIII13*2/D750GB7.2KS*1/ NSM8XSLFSLLOT/B23/HD4570/A336-D/ 802.11bgn/bluetooth/US Win7 WMC/mouse/ mouse
AZ5610	AAP	ACA	Australia/ New Zealand	PW.SCY02.028	AZ5610 AAP001 W7HP64AUHP5/C2DE7500/ U2GBIII13*2/D750GB7.2KS*1/ NSM8XSLFSLLOT/B23/HD4570/A336-D/ 802.11bgn/bluetooth/US Win7 WMC/mouse/ mouse
AZ5610	AAP	ACA	Australia/ New Zealand	PW.SCY02.027	AZ5610 AAP001 W7HP64AUHP5/ C2QQ8200s/U2GBIII13*3/D1000GB7.2KS*1/ NSM8XSLFSLLOT/B23/vga/A336-D/ 802.11bgn/bluetooth/US Win7 WMC/mouse/ mouse
AZ5610	AAP	ACA	Australia/ New Zealand	PW.SCY02.027	AZ5610 AAP001 W7HP64AUHP5/ C2QQ8200s/U2GBIII13*3/D1000GB7.2KS*1/ NSM8XSLFSLLOT/B23/vga/A336-D/ 802.11bgn/bluetooth/US Win7 WMC/mouse/ mouse
AZ5610	AAP	ACA	Australia/ New Zealand	PW.SCY02.027	AZ5610 AAP001 W7HP64AUHP5/ C2QQ8200s/U2GBIII13*3/D1000GB7.2KS*1/ NSM8XSLFSLLOT/B23/vga/A336-D/ 802.11bgn/bluetooth/US Win7 WMC/mouse/ mouse
AZ5610	EMEA	ACG	Germany	PW.SCY02.021	AZ5610 EMEA001 W7HP64R03a/ C2QQ8200s/U2GBIII13*2/D1000GB7.2KS*1/ NSM8XSLFSLLOT/B23/HD4570/802.11bgn/ bluetooth/mouse/mouse
AZ5610	EMEA	ACG	Germany	PW.SCY02.021	AZ5610 EMEA001 W7HP64R03a/ C2QQ8200s/U2GBIII13*2/D1000GB7.2KS*1/ NSM8XSLFSLLOT/B23/HD4570/802.11bgn/ bluetooth/mouse/mouse
AZ5610	TWN	GCTWN	Taiwan	PW.SCY02.001	AZ5610 TWN001 W7HP64TWHP2/ C2QQ8200s/U2GBIII13*2/D1000GB7.2KS*1/ NSM8XSLFSLLOT/B23/vga/802.11bgn/ bluetooth/mouse/mouse
AZ5610	AAP	ATH	Thailand	PW.SCY02.020	AZ5610 AAP001 W7HP64EMTHa01/ C2DE7600/U2GBIII13*1/D750GB7.2KS*1/ NSM8XSLFSLLOT/B23/HD4570/802.11bgn/ bluetooth/mouse/mouse
AZ5610	AAP	ATH	Thailand	PW.SCY02.020	AZ5610 AAP001 W7HP64EMTHa01/ C2DE7600/U2GBIII13*1/D750GB7.2KS*1/ NSM8XSLFSLLOT/B23/HD4570/802.11bgn/ bluetooth/mouse/mouse
AZ5610	AAP	ATH	Thailand	PW.SCY02.020	AZ5610 AAP001 W7HP64EMTHa01/ C2DE7600/U2GBIII13*1/D750GB7.2KS*1/ NSM8XSLFSLLOT/B23/HD4570/802.11bgn/ bluetooth/mouse/mouse

Model Name	RO	NS	Country	Acer Part no	Description
AZ5610	EMEA	ACF	France	PW.SCY02.018	AZ5610 EMEA001 W7HP64R02a/C2DE7500/ U2GBIII13*2/D750GB7.2KS*1/ NSM8XSLFSL0T/B23/HD4570/802.11bgn/ bluetooth/mouse/mouse
AZ5610	EMEA	ACF	France	PW.SCY02.018	AZ5610 EMEA001 W7HP64R02a/C2DE7500/ U2GBIII13*2/D750GB7.2KS*1/ NSM8XSLFSL0T/B23/HD4570/802.11bgn/ bluetooth/mouse/mouse
AZ5610	CHINA	ACCN	China	PW.SCY02.016	AZ5610 CHINA001 W7HP64SCCNa01/ C2QQ8200s/U2GBIII13*2/D1000GB7.2KS*1/ NSM8XSLFSL0T/B23/HD4570/802.11bgn/ bluetooth/mouse/mouse
AZ5610	AAP	AVN	Vietnam	PW.SCY02.015	AZ5610 AAP001 W7HP64EMVNa01/ C2QQ8200s/U2GBIII13*2/D1000GB7.2KS*1/ NSM8XSLFSL0T/B23/HD4570/802.11bgn/ bluetooth/mouse/mouse
AZ5610	AAP	ATH	Thailand	PW.SCY02.014	AZ5610 AAP001 W7HP64EMTHa01/ C2QQ8200s/U2GBIII13*2/D1000GB7.2KS*1/ NSM8XSLFSL0T/B23/HD4570/802.11bgn/ bluetooth/mouse/mouse
AZ5610	AAP	ATH	Thailand	PW.SCY02.014	AZ5610 AAP001 W7HP64EMTHa01/ C2QQ8200s/U2GBIII13*2/D1000GB7.2KS*1/ NSM8XSLFSL0T/B23/HD4570/802.11bgn/ bluetooth/mouse/mouse
AZ5610	AAP	AVN	Vietnam	PW.SCY02.015	AZ5610 AAP001 W7HP64EMVNa01/ C2QQ8200s/U2GBIII13*2/D1000GB7.2KS*1/ NSM8XSLFSL0T/B23/HD4570/802.11bgn/ bluetooth/mouse/mouse
AZ5610	AAP	ATH	Thailand	PW.SCY02.014	AZ5610 AAP001 W7HP64EMTHa01/ C2QQ8200s/U2GBIII13*2/D1000GB7.2KS*1/ NSM8XSLFSL0T/B23/HD4570/802.11bgn/ bluetooth/mouse/mouse
AZ5610	AAP	AVN	Vietnam	PW.SCY02.015	AZ5610 AAP001 W7HP64EMVNa01/ C2QQ8200s/U2GBIII13*2/D1000GB7.2KS*1/ NSM8XSLFSL0T/B23/HD4570/802.11bgn/ bluetooth/mouse/mouse
AZ5610	AAP	ACA	Australia/ New Zealand	PW.SCY02.013	AZ5610 AAP001 W7HP64AUHP5/PDCE5400/ U2GBIII13*2/D640GB7.2KS*1/ NSM8XSLFSL0T/B23/HD4570/802.11bgn/ bluetooth/mouse/mouse
AZ5610	AAP	ACA	Australia/ New Zealand	PW.SCY02.013	AZ5610 AAP001 W7HP64AUHP5/PDCE5400/ U2GBIII13*2/D640GB7.2KS*1/ NSM8XSLFSL0T/B23/HD4570/802.11bgn/ bluetooth/mouse/mouse
AZ5610	AAP	ACA	Australia/ New Zealand	PW.SCY02.013	AZ5610 AAP001 W7HP64AUHP5/PDCE5400/ U2GBIII13*2/D640GB7.2KS*1/ NSM8XSLFSL0T/B23/HD4570/802.11bgn/ bluetooth/mouse/mouse
AZ5610	TWN	GCTWN	Taiwan	PW.SCY02.002	AZ5610 TWN001 W7HP64TWHP2/ C2QQ8200s/U2GBIII13*2/D1000GB7.2KS*1/ NSM8XSLFSL0T/B23/802.11bgn/bluetooth/ KB/mouse

Model Name	RO	NS	Country	Acer Part no	Description
AZ5610	TWN	GCTWN	Taiwan	PW.SCY02.003	AZ5610 TWN001 W7HP64TWHWP2/ C2DE7500/U2GBIII13*1/D750GB7.2KS*1/ NSM8XSLFSLLOT/B23/802.11bgn/bluetooth/ KB/mouse
AZ5610	AAP	ACA	Australia/ New Zealand	PW.SCY02.011	AZ5610 AAP001 W7HP64AUHP5/PDCE5400/ U2GBIII13*1+U1GBIII13*1/D640GB7.2KS*1/ NSM8XSLFSLLOT/B23/802.11bgn/bluetooth/ KB/mouse
AZ5610	AAP	ACA	Australia/ New Zealand	PW.SCY02.012	AZ5610 AAP001 W7HP64AUHP5/C2DE7500/ U2GBIII13*2/D750GB7.2KS*1/ NSM8XSLFSLLOT/B23/802.11bgn/bluetooth/ KB/mouse
AZ5610	AAP	ACA	Australia/ New Zealand	PW.SCY02.012	AZ5610 AAP001 W7HP64AUHP5/C2DE7500/ U2GBIII13*2/D750GB7.2KS*1/ NSM8XSLFSLLOT/B23/802.11bgn/bluetooth/ KB/mouse
AZ5610	AAP	ACA	Australia/ New Zealand	PW.SCY02.012	AZ5610 AAP001 W7HP64AUHP5/C2DE7500/ U2GBIII13*2/D750GB7.2KS*1/ NSM8XSLFSLLOT/B23/802.11bgn/bluetooth/ KB/mouse
AZ5610	AAP	AIN	Indonesia	PW.SCY02.008	AZ5610 AAP001 W7HP64EMID1/ C2QQ8200s/U2GBIII13*2/D1000GB7.2KS*1/ NSM8XSLFSLLOT/B23/802.11bgn/bluetooth/ KB/mouse
AZ5610	AAP	AIN	Indonesia	PW.SCY02.008	AZ5610 AAP001 W7HP64EMID1/ C2QQ8200s/U2GBIII13*2/D1000GB7.2KS*1/ NSM8XSLFSLLOT/B23/802.11bgn/bluetooth/ KB/mouse
AZ5610	AAP	AIN	Indonesia	PW.SCY02.008	AZ5610 AAP001 W7HP64EMID1/ C2QQ8200s/U2GBIII13*2/D1000GB7.2KS*1/ NSM8XSLFSLLOT/B23/802.11bgn/bluetooth/ KB/mouse
AZ5610	AAP	APHI	Philippines	PW.SCY02.009	AZ5610 AAP001 W7HP64EMPH5/ C2QQ8200s/U2GBIII13*2/D1000GB7.2KS*1/ NSM8XSLFSLLOT/B23/802.11bgn/bluetooth/ KB/mouse
AZ5610	AAP	APHI	Philippines	PW.SCY02.009	AZ5610 AAP001 W7HP64EMPH5/ C2QQ8200s/U2GBIII13*2/D1000GB7.2KS*1/ NSM8XSLFSLLOT/B23/802.11bgn/bluetooth/ KB/mouse
AZ5610	AAP	APHI	Philippines	PW.SCY02.009	AZ5610 AAP001 W7HP64EMPH5/ C2QQ8200s/U2GBIII13*2/D1000GB7.2KS*1/ NSM8XSLFSLLOT/B23/802.11bgn/bluetooth/ KB/mouse
AZ5610	AAP	ACA	Australia/ New Zealand	PW.SCY02.011	AZ5610 AAP001 W7HP64AUHP5/PDCE5400/ U2GBIII13*1+U1GBIII13*1/D640GB7.2KS*1/ NSM8XSLFSLLOT/B23/802.11bgn/bluetooth/ KB/mouse
AZ5610	AAP	ACA	Australia/ New Zealand	PW.SCY02.011	AZ5610 AAP001 W7HP64AUHP5/PDCE5400/ U2GBIII13*1+U1GBIII13*1/D640GB7.2KS*1/ NSM8XSLFSLLOT/B23/802.11bgn/bluetooth/ KB/mouse

Model Name	RO	NS	Country	Acer Part no	Description
AZ5610	AAP	ASSSB	Malaysia	PW.SCY02.010	AZ5610 AAP001 W7HP64EMMY1/ C2QQ8200s/U2GBIII13*2/D1000GB7.2KS*1/ NSM8XSLFSLLOT/B23/802.11bgn/bluetooth/ KB/mouse
AZ5610	AAP	ASSSB	Malaysia	PW.SCY02.010	AZ5610 AAP001 W7HP64EMMY1/ C2QQ8200s/U2GBIII13*2/D1000GB7.2KS*1/ NSM8XSLFSLLOT/B23/802.11bgn/bluetooth/ KB/mouse
AZ5610	AAP	ASSSB	Malaysia	PW.SCY02.010	AZ5610 AAP001 W7HP64EMMY1/ C2QQ8200s/U2GBIII13*2/D1000GB7.2KS*1/ NSM8XSLFSLLOT/B23/802.11bgn/bluetooth/ KB/mouse
AZ5610	AAP	AIL	India	PW.SCY02.006	AZ5610 AAP001 W7HP64INW1/C2QQ8200s/ U2GBIII13*2/D1000GB7.2KS*1/ NSM8XSLFSLLOT/B23/802.11bgn/bluetooth/ KB/mouse
AZ5610	AAP	AIL	India	PW.SCY02.006	AZ5610 AAP001 W7HP64INW1/C2QQ8200s/ U2GBIII13*2/D1000GB7.2KS*1/ NSM8XSLFSLLOT/B23/802.11bgn/bluetooth/ KB/mouse
AZ5610	AAP	AIL	India	PW.SCY02.006	AZ5610 AAP001 W7HP64INW1/C2QQ8200s/ U2GBIII13*2/D1000GB7.2KS*1/ NSM8XSLFSLLOT/B23/802.11bgn/bluetooth/ KB/mouse
AZ5610	AAP	ACA	Australia/ New Zealand	PW.SCY02.004	AZ5610 AAP001 W7HP64AUHP5/ C2QQ8200s/U2GBIII13*3/D1000GB7.2KS*1/ NSM8XSLFSLLOT/B23/vga/802.11bgn/ bluetooth/KB/mouse
AZ5610	AAP	ACA	Australia/ New Zealand	PW.SCY02.004	AZ5610 AAP001 W7HP64AUHP5/ C2QQ8200s/U2GBIII13*3/D1000GB7.2KS*1/ NSM8XSLFSLLOT/B23/vga/802.11bgn/ bluetooth/KB/mouse
AZ5610	AAP	ACA	Australia/ New Zealand	PW.SCY02.004	AZ5610 AAP001 W7HP64AUHP5/ C2QQ8200s/U2GBIII13*3/D1000GB7.2KS*1/ NSM8XSLFSLLOT/B23/vga/802.11bgn/ bluetooth/KB/mouse

Model Name	Chassis	Bezel	MB	PSU
AZ5600	Acer Santana 23 inch AIO	23 inch aSantana Silver LC Bezel	aSantana QIG45M_1394(N)_Logo(N)	FR 250W (AIO) EuP 82+_Acer
AZ5600	Acer Santana 23 inch AIO	23 inch aSantana Silver LC Bezel	aSantana QIG45M_1394(N)_Logo(N)	FR 250W (AIO) EuP 82+_Acer
AZ5600	Acer Santana 23 inch AIO	23 inch aSantana Silver LC Bezel	aSantana QIG45M_1394(N)_Logo(N)	FR 250W (AIO) EuP 82+_Acer
AZ5600	Acer Santana 23 inch AIO	23 inch aSantana Silver LC Bezel	aSantana QIG45M_1394(N)_Logo(N)	FR 250W (AIO) EuP 82+_Acer

Model Name	Chassis	Bezel	MB	PSU
AZ5600	Acer Santana 23 inch AIO	23 inch aSantana Silver LC Bezel	aSantana QIG45M_1394(N)_Logo(N)	FR 250W (AIO) EuP 82+_Acer
AZ5600	Acer Santana 23 inch AIO	23 inch aSantana Silver LC Bezel	aSantana QIG45M_1394(N)_Logo(N)	FR 250W (AIO) EuP 82+_Acer
AZ5600	Acer Santana 23 inch AIO	23 inch aSantana Silver LC Bezel	aSantana QIG45M_1394(N)_Logo(N)	FR 250W (AIO) EuP 82+_Acer
AZ5600	Acer Santana 23 inch AIO	23 inch aSantana Silver LC Bezel	aSantana QIG45M_1394(N)_Logo(N)	FR 250W (AIO) EuP 82+_Acer
AZ5600	Acer Santana 23 inch AIO	23 inch aSantana Silver LC Bezel	aSantana QIG45M_1394(N)_Logo(N)	FR 250W (AIO) EuP 82+_Acer
AZ5600	Acer Santana 23 inch AIO	23 inch aSantana Silver LC Bezel	aSantana QIG45M_1394(N)_Logo(N)	FR 250W (AIO) EuP 82+_Acer
AZ5600	Acer Santana 23 inch AIO	23 inch aSantana Silver LC Bezel	aSantana QIG45M_1394(N)_Logo(N)	FR 250W (AIO) EuP 82+_Acer
AZ5600	Acer Santana 23 inch AIO	23 inch aSantana Silver LC Bezel	aSantana QIG45M_1394(N)_Logo(N)	FR 250W (AIO) EuP 82+_Acer
AZ5610	Acer Santana 23 inch AIO	23 inch aSantana Silver LC Bezel	Santana_Discrete QIG45M_1394(N)_Logo(N)	FR 250W (AIO) EuP 82+_Acer
AZ5610	Acer Santana 23 inch AIO	23 inch aSantana Silver LC Bezel	Santana_Discrete QIG45M_1394(N)_Logo(N)	FR 250W (AIO) EuP 82+_Acer
AZ5610	Acer Santana 23 inch AIO	23 inch aSantana Silver LC Bezel	Santana_Discrete QIG45M_1394(N)_Logo(N)	FR 250W (AIO) EuP 82+_Acer
AZ5610	Acer Santana 23 inch AIO	23 inch aSantana Silver LC Bezel	Santana_Discrete QIG45M_1394(N)_Logo(N)	FR 250W (AIO) EuP 82+_Acer
AZ5610	Acer Santana 23 inch AIO	23 inch aSantana Silver LC Bezel	Santana_Discrete QIG45M_1394(N)_Logo(N)	FR 250W (AIO) EuP 82+_Acer
AZ5610	Acer Santana 23 inch AIO	23 inch aSantana Silver LC Bezel	Santana_Discrete QIG45M_1394(N)_Logo(N)	FR 250W (AIO) EuP 82+_Acer
AZ5610	Acer Santana 23 inch AIO	23 inch aSantana Silver LC Bezel	Santana_Discrete QIG45M_1394(N)_Logo(N)	FR 250W (AIO) EuP 82+_Acer
AZ5610	Acer Santana 23 inch AIO	23 inch aSantana Silver LC Bezel	Santana_Discrete QIG45M_1394(N)_Logo(N)	FR 250W (AIO) EuP 82+_Acer
AZ5610	Acer Santana 23 inch AIO	23 inch aSantana Silver LC Bezel	Santana_Discrete QIG45M_1394(N)_Logo(N)	FR 250W (AIO) EuP 82+_Acer
AZ5610	Acer Santana 23 inch AIO	23 inch aSantana Silver LC Bezel	Santana_Discrete QIG45M_1394(N)_Logo(N)	FR 250W (AIO) EuP 82+_Acer

Model Name	Chassis	Bezel	MB	PSU
AZ5610	Acer Santana 23 inch AIO	23 inch aSantana Silver LC Bezel	Santana_Discrete QIG45M_1394(N)_Logo(N)	FR 250W (AIO) EuP 82+_Acer
AZ5610	Acer Santana 23 inch AIO	23 inch aSantana Silver LC Bezel	Santana_Discrete QIG45M_1394(N)_Logo(N)	FR 250W (AIO) EuP 82+_Acer
AZ5610	Acer Santana 23 inch AIO	23 inch aSantana Silver LC Bezel	Santana_Discrete QIG45M_1394(N)_Logo(N)	FR 250W (AIO) EuP 82+_Acer
AZ5610	Acer Santana 23 inch AIO	23 inch aSantana Silver LC Bezel	Santana_Discrete QIG45M_1394(N)_Logo(N)	FR 250W (AIO) EuP 82+_Acer
AZ5610	Acer Santana 23 inch AIO	23 inch aSantana Silver LC Bezel	Santana_Discrete QIG45M_1394(N)_Logo(N)	FR 250W (AIO) EuP 82+_Acer
AZ5610	Acer Santana 23 inch AIO	23 inch aSantana Silver LC Bezel	Santana_Discrete QIG45M_1394(N)_Logo(N)	FR 250W (AIO) EuP 82+_Acer
AZ5610	Acer Santana 23 inch AIO	23 inch aSantana Silver LC Bezel	Santana_Discrete QIG45M_1394(N)_Logo(N)	FR 250W (AIO) EuP 82+_Acer
AZ5610	Acer Santana 23 inch AIO	23 inch aSantana Silver LC Bezel	Santana_Discrete QIG45M_1394(N)_Logo(N)	FR 250W (AIO) EuP 82+_Acer
AZ5610	Acer Santana 23 inch AIO	23 inch aSantana Silver LC Bezel	Santana_Discrete QIG45M_1394(N)_Logo(N)	FR 250W (AIO) EuP 82+_Acer
AZ5610	Acer Santana 23 inch AIO	23 inch aSantana Silver LC Bezel	Santana_Discrete QIG45M_1394(N)_Logo(N)	FR 250W (AIO) EuP 82+_Acer
AZ5610	Acer Santana 23 inch AIO	23 inch aSantana Silver LC Bezel	Santana_Discrete QIG45M_1394(N)_Logo(N)	FR 250W (AIO) EuP 82+_Acer
AZ5610	Acer Santana 23 inch AIO	23 inch aSantana Silver LC Bezel	Santana_Discrete QIG45M_1394(N)_Logo(N)	FR 250W (AIO) EuP 82+_Acer
AZ5610	Acer Santana 23 inch AIO	23 inch aSantana Silver LC Bezel	Santana_Discrete QIG45M_1394(N)_Logo(N)	FR 250W (AIO) EuP 82+_Acer
AZ5610	Acer Santana 23 inch AIO	23 inch aSantana Silver LC Bezel	Santana_Discrete QIG45M_1394(N)_Logo(N)	FR 250W (AIO) EuP 82+_Acer
AZ5610	Acer Santana 23 inch AIO	23 inch aSantana Silver LC Bezel	Santana_Discrete QIG45M_1394(N)_Logo(N)	FR 250W (AIO) EuP 82+_Acer
AZ5610	Acer Santana 23 inch AIO	23 inch aSantana Silver LC Bezel	Santana_Discrete QIG45M_1394(N)_Logo(N)	FR 250W (AIO) EuP 82+_Acer
AZ5610	Acer Santana 23 inch AIO	23 inch aSantana Silver LC Bezel	Santana_Discrete QIG45M_1394(N)_Logo(N)	FR 250W (AIO) EuP 82+_Acer
AZ5610	Acer Santana 23 inch AIO	23 inch aSantana Silver LC Bezel	Santana_Discrete QIG45M_1394(N)_Logo(N)	FR 250W (AIO) EuP 82+_Acer
AZ5610	Acer Santana 23 inch AIO	23 inch aSantana Silver LC Bezel	Santana_Discrete QIG45M_1394(N)_Logo(N)	FR 250W (AIO) EuP 82+_Acer

Model Name	FDD	Card Reader	CPU	Memory 1	Memory 2	Memory 3	Memory 4	Memory 5	Memory 6
AZ5600	N	Y	PDCE6300	U2GBIII13	U2GBIII13	N	N	N	N
AZ5600	N	Y	PDCE6300	U2GBIII13	U2GBIII13	N	N	N	N

Model Name	FDD	Card Reader	CPU	Memory 1	Memory 2	Memory 3	Memory 4	Memory 5	Memory 6
AZ5600	N	Y	PDCE5300	U2GBIII13	N	N	N	N	N
AZ5600	N	Y	PDCE5300	U2GBIII13	N	N	N	N	N
AZ5600	N	Y	PDCE6500	U2GBIII13	N	N	N	N	N
AZ5600	N	Y	PDCE6500	U2GBIII13	N	N	N	N	N
AZ5600	N	Y	PDCE6500	U2GBIII13	N	N	N	N	N
AZ5600	N	Y	PDCE5300	U2GBIII13	U2GBIII13	N	N	N	N
AZ5600	N	Y	PDCE5300	U2GBIII13	U2GBIII13	N	N	N	N
AZ5600	N	Y	PDCE6300	U2GBIII13	N	N	N	N	N
AZ5600	N	Y	PDCE6500	U2GBIII13	N	N	N	N	N
AZ5600	N	Y	PDCE6500	U2GBIII13	N	N	N	N	N
AZ5600	N	Y	PDCE6500	U2GBIII13	N	N	N	N	N
AZ5600	N	Y	C2DE7600	U1GBIII13	U1GBIII13	N	N	N	N
AZ5600	N	Y	PDCE5400	U2GBIII13	N	N	N	N	N
AZ5600	N	Y	PDCE5400	U2GBIII13	N	N	N	N	N
AZ5600	N	Y	PDCE5400	U2GBIII13	N	N	N	N	N
AZ5600	N	Y	PDCE5400	U2GBIII13	N	N	N	N	N
AZ5600	N	Y	PDCE5400	U2GBIII13	N	N	N	N	N
AZ5600	N	Y	PDCE5400	U2GBIII13	N	N	N	N	N
AZ5600	N	Y	PDCE5400	U2GBIII13	N	N	N	N	N
AZ5600	N	Y	PDCE5400	U2GBIII13	N	N	N	N	N
AZ5600	N	Y	PDCE5400	U2GBIII13	N	N	N	N	N
AZ5600	N	Y	PDCE5400	U2GBIII13	N	N	N	N	N
AZ5600	N	Y	PDCE5400	U2GBIII13	N	N	N	N	N
AZ5600	N	Y	PDCE5400	U2GBIII13	N	N	N	N	N
AZ5600	N	Y	PDCE5400	U2GBIII13	N	N	N	N	N
AZ5600	N	Y	PDCE5400	U2GBIII13	N	N	N	N	N
AZ5600	N	Y	PDCE5400	U2GBIII13	N	N	N	N	N
AZ5600	N	Y	PDCE5400	U2GBIII13	N	N	N	N	N
AZ5600	N	Y	PDCE5400	U2GBIII13	N	N	N	N	N
AZ5600	N	Y	PDCE5400	U2GBIII13	N	N	N	N	N
AZ5600	N	Y	PDCE5400	U2GBIII13	N	N	N	N	N
AZ5600	N	Y	PDCE5400	U2GBIII13	N	N	N	N	N
AZ5600	N	Y	PDCE5400	U2GBIII13	N	N	N	N	N
AZ5600	N	Y	PDCE5400	U2GBIII13	N	N	N	N	N
AZ5600	N	Y	PDCE5400	U2GBIII13	N	N	N	N	N
AZ5600	N	Y	PDCE5400	U2GBIII13	N	N	N	N	N
AZ5600	N	Y	C2QQ8200s	U2GBIII13	U2GBIII13	N	N	N	N
AZ5600	N	Y	C2QQ8200s	U2GBIII13	U2GBIII13	N	N	N	N
AZ5600	N	Y	C2QQ8200s	U2GBIII13	U2GBIII13	N	N	N	N
AZ5600	N	Y	PDCE5400	U2GBIII13	N	N	N	N	N
AZ5600	N	Y	C2QQ9400s	U2GBIII13	U2GBIII13	U2GBIII13	U2GBIII13	N	N
AZ5600	N	Y	PDCE5400	U2GBIII13	N	N	N	N	N
AZ5600	N	Y	PDCE5400	U2GBIII13	N	N	N	N	N
AZ5600	N	Y	PDCE5400	U2GBIII13	N	N	N	N	N

Model Name	FDD	Card Reader	CPU	Memory 1	Memory 2	Memory 3	Memory 4	Memory 5	Memory 6
AZ5600	N	Y	C2QQ8200s	U2GBIII13	U2GBIII13	U2GBIII13	U2GBIII13	N	N
AZ5600	N	Y	C2DE8400	U2GBIII13	U2GBIII13	U2GBIII13	U2GBIII13	N	N
AZ5610	N	Y	C2QQ8200s	U2GBIII13	U2GBIII13	U2GBIII13	U2GBIII13	N	N
AZ5610	N	Y	C2DE7500	U2GBIII13	U2GBIII13	N	N	N	N
AZ5610	N	Y	C2DE7500	U2GBIII13	U2GBIII13	N	N	N	N
AZ5610	N	Y	C2DE7500	U2GBIII13	U2GBIII13	N	N	N	N
AZ5610	N	Y	C2DE7500	U2GBIII13	U2GBIII13	N	N	N	N
AZ5610	N	Y	C2DE7500	U2GBIII13	U2GBIII13	N	N	N	N
AZ5610	N	Y	C2DE7500	U2GBIII13	U2GBIII13	N	N	N	N
AZ5610	N	Y	C2DE7500	U2GBIII13	U2GBIII13	N	N	N	N
AZ5610	N	Y	C2DE7500	U2GBIII13	U2GBIII13	N	N	N	N
AZ5610	N	Y	C2DE7500	U2GBIII13	U2GBIII13	N	N	N	N
AZ5610	N	Y	C2QQ8200s	U2GBIII13	U2GBIII13	N	N	N	N
AZ5610	N	Y	PDCE5300	U2GBIII13	N	N	N	N	N
AZ5610	N	Y	C2QQ9400s	U2GBIII13	U2GBIII13	N	N	N	N
AZ5610	N	Y	C2QQ8200s	U2GBIII13	U2GBIII13	N	N	N	N
AZ5610	N	Y	C2QQ8200s	U2GBIII13	U2GBIII13	U2GBIII13	U2GBIII13	N	N
AZ5610	N	Y	C2QQ8200s	U2GBIII13	U2GBIII13	N	N	N	N
AZ5610	N	Y	C2QQ8200s	U2GBIII13	U2GBIII13	N	N	N	N
AZ5610	N	Y	C2QQ8200s	U2GBIII13	U2GBIII13	N	N	N	N
AZ5610	N	Y	C2QQ9400s	U2GBIII13	U2GBIII13	U2GBIII13	U2GBIII13	N	N
AZ5610	N	Y	C2DE7500	U2GBIII13	U2GBIII13	N	N	N	N
AZ5610	N	Y	C2DE7500	U2GBIII13	U2GBIII13	N	N	N	N
AZ5610	N	Y	C2DE7500	U2GBIII13	U2GBIII13	N	N	N	N
AZ5610	N	Y	C2QQ9400s	U2GBIII13	U2GBIII13	U2GBIII13	U2GBIII13	N	N
AZ5610	N	Y	C2QQ9400s	U2GBIII13	U2GBIII13	U2GBIII13	U2GBIII13	N	N
AZ5610	N	Y	C2QQ8200s	U2GBIII13	U2GBIII13	N	N	N	N
AZ5610	N	Y	C2QQ8200s	U2GBIII13	U2GBIII13	N	N	N	N
AZ5610	N	Y	PDCE5300	U2GBIII13	U2GBIII13	N	N	N	N
AZ5610	N	Y	PDCE5300	U2GBIII13	U2GBIII13	N	N	N	N
AZ5610	N	Y	C2QQ8200s	U2GBIII13	U2GBIII13	N	N	N	N
AZ5610	N	Y	C2QQ8200s	U2GBIII13	U2GBIII13	N	N	N	N
AZ5610	N	Y	C2QQ8200s	U2GBIII13	U2GBIII13	N	N	N	N
AZ5610	N	Y	C2QQ8200s	U2GBIII13	U2GBIII13	N	N	N	N
AZ5610	N	Y	C2QQ8200s	U2GBIII13	U2GBIII13	N	N	N	N
AZ5610	N	Y	C2QQ8200s	U2GBIII13	U2GBIII13	N	N	N	N
AZ5610	N	Y	C2QQ8200s	U2GBIII13	U2GBIII13	N	N	N	N
AZ5610	N	Y	C2QQ8200s	U2GBIII13	U2GBIII13	N	N	N	N
AZ5610	N	Y	C2QQ8200s	U2GBIII13	U2GBIII13	N	N	N	N

Model Name	FDD	Card Reader	CPU	Memory 1	Memory 2	Memory 3	Memory 4	Memory 5	Memory 6
AZ5610	N	Y	C2QQ8200s	U2GBIII13	U2GBIII13	N	N	N	N
AZ5610	N	Y	C2QQ9400s	U2GBIII13	U2GBIII13	U2GBIII13	U2GBIII13	N	N
AZ5610	N	Y	C2QQ8200s	U2GBIII13	U2GBIII13	N	N	N	N
AZ5610	N	Y	C2QQ8200s	U2GBIII13	U2GBIII13	N	N	N	N
AZ5610	N	Y	C2QQ8200s	U2GBIII13	U2GBIII13	N	N	N	N
AZ5610	N	Y	C2QQ8200s	U2GBIII13	U2GBIII13	N	N	N	N
AZ5610	N	Y	C2DE7500	U2GBIII13	U2GBIII13	N	N	N	N
AZ5610	N	Y	C2DE7500	U2GBIII13	U2GBIII13	N	N	N	N
AZ5610	N	Y	C2QQ8200s	U2GBIII13	U2GBIII13	N	N	N	N
AZ5610	N	Y	C2QQ8200s	U2GBIII13	U2GBIII13	N	N	N	N
AZ5610	N	Y	C2QQ9400s	U2GBIII13	U2GBIII13	N	N	N	N
AZ5610	N	Y	C2QQ9400s	U2GBIII13	U2GBIII13	N	N	N	N
AZ5610	N	Y	C2QQ8200s	U2GBIII13	U2GBIII13	N	N	N	N
AZ5610	N	Y	C2QQ8200s	U2GBIII13	U2GBIII13	N	N	N	N
AZ5610	N	Y	C2QQ9400s	U2GBIII13	U2GBIII13	N	N	N	N
AZ5610	N	Y	C2QQ9400s	U2GBIII13	U2GBIII13	N	N	N	N
AZ5610	N	Y	C2QQ8200s	U2GBIII13	U2GBIII13	N	N	N	N
AZ5610	N	Y	C2QQ8200s	U2GBIII13	U2GBIII13	U2GBIII13	U2GBIII13	N	N
AZ5610	N	Y	PDCE6300	U2GBIII13	U2GBIII13	N	N	N	N
AZ5610	N	Y	C2DE7500	U2GBIII13	U2GBIII13	U2GBIII13	U2GBIII13	N	N
AZ5610	N	Y	C2DE7500	U2GBIII13	U2GBIII13	N	N	N	N
AZ5610	N	Y	C2DE7500	U2GBIII13	U2GBIII13	N	N	N	N
AZ5610	N	Y	C2DE7500	U2GBIII13	U2GBIII13	N	N	N	N
AZ5610	N	Y	C2QQ8200s	U2GBIII13	U2GBIII13	N	N	N	N
AZ5610	N	Y	C2QQ8200s	U2GBIII13	U2GBIII13	N	N	N	N
AZ5610	N	Y	C2QQ8200s	U2GBIII13	U2GBIII13	N	N	N	N
AZ5610	N	Y	C2QQ8200s	U2GBIII13	U2GBIII13	N	N	N	N
AZ5610	N	Y	PDCE6300	U1GBIII13	U2GBIII13	N	N	N	N
AZ5610	N	Y	C2QQ8400s	U2GBIII13	U2GBIII13	N	N	N	N
AZ5610	N	Y	C2QQ8400s	U2GBIII13	U2GBIII13	N	N	N	N
AZ5610	N	Y	PDCE5300	U2GBIII13	U2GBIII13	N	N	N	N
AZ5610	N	Y	PDCE5300	U2GBIII13	U2GBIII13	N	N	N	N
AZ5610	N	Y	C2DE7500	U2GBIII13	U2GBIII13	N	N	N	N
AZ5610	N	Y	C2DE7500	U1GBIII13	U2GBIII13	N	N	N	N
AZ5610	N	Y	C2DE7500	U1GBIII13	U2GBIII13	N	N	N	N
AZ5610	N	Y	C2DE7500	U1GBIII13	U2GBIII13	N	N	N	N
AZ5610	N	Y	PDCE5300	U2GBIII13	U2GBIII13	N	N	N	N
AZ5610	N	Y	C2QQ9400s	U2GBIII13	U2GBIII13	N	N	N	N
AZ5610	N	Y	C2QQ8400s	U2GBIII13	U2GBIII13	N	N	N	N
AZ5610	N	Y	C2QQ8400s	U2GBIII13	U2GBIII13	N	N	N	N

Model Name	FDD	Card Reader	CPU	Memory 1	Memory 2	Memory 3	Memory 4	Memory 5	Memory 6
AZ5610	N	Y	PDCE5400	U2GBIII13	U1GBIII13	N	N	N	N
AZ5610	N	Y	PDCE5400	U2GBIII13	U1GBIII13	N	N	N	N
AZ5610	N	Y	C2QQ8200s	U2GBIII13	U2GBIII13	N	N	N	N
AZ5610	N	Y	C2QQ8200s	U2GBIII13	U2GBIII13	N	N	N	N
AZ5610	N	Y	C2QQ8200s	U2GBIII13	U2GBIII13	N	N	N	N
AZ5610	N	Y	C2QQ8200s	U2GBIII13	U2GBIII13	N	N	N	N
AZ5610	N	Y	C2QQ8200s	U2GBIII13	U2GBIII13	N	N	N	N
AZ5610	N	Y	C2QQ8200s	U2GBIII13	U2GBIII13	U2GBIII13	N	N	N
AZ5610	N	Y	C2QQ8200s	U2GBIII13	U2GBIII13	U2GBIII13	N	N	N
AZ5610	N	Y	C2QQ8200s	U2GBIII13	U2GBIII13	U2GBIII13	N	N	N

Model Name	HDD 1 (GB)	HDD 2 (GB)	HDD 3 (GB)	HDD 4 (GB)	ODD1	ODD2
AZ5600	D750GB7.2KS	N	N	N	NSM8XSLFSLOT	N
AZ5600	D750GB7.2KS	N	N	N	NSM8XSLFSLOT	N
AZ5600	D320GB7.2KS	N	N	N	NSM8XSLFSLOT	N
AZ5600	D320GB7.2KS	N	N	N	NSM8XSLFSLOT	N
AZ5600	D750GB7.2KS	N	N	N	NSM8XSLFSLOT	N
AZ5600	D750GB7.2KS	N	N	N	NSM8XSLFSLOT	N
AZ5600	D750GB7.2KS	N	N	N	NSM8XSLFSLOT	N
AZ5600	D640GB7.2KS	N	N	N	NSM8XSLFSLOT	N
AZ5600	D750GB7.2KS	N	N	N	NSM8XSLFSLOT	N
AZ5600	D750GB7.2KS	N	N	N	NSM8XSLFSLOT	N
AZ5600	D750GB7.2KS	N	N	N	NSM8XSLFSLOT	N
AZ5600	D750GB7.2KS	N	N	N	NSM8XSLFSLOT	N
AZ5600	D750GB7.2KS	N	N	N	NSM8XSLFSLOT	N
AZ5600	D750GB7.2KS	N	N	N	NSM8XSLFSLOT	N
AZ5600	D750GB7.2KS	N	N	N	NSM8XSLFSLOT	N
AZ5600	D750GB7.2KS	N	N	N	NSM8XSLFSLOT	N
AZ5600	D750GB7.2KS	N	N	N	NSM8XSLFSLOT	N
AZ5600	D750GB7.2KS	N	N	N	NSM8XSLFSLOT	N
AZ5600	D750GB7.2KS	N	N	N	NSM8XSLFSLOT	N
AZ5600	D750GB7.2KS	N	N	N	NSM8XSLFSLOT	N
AZ5600	D750GB7.2KS	N	N	N	NSM8XSLFSLOT	N
AZ5600	D750GB7.2KS	N	N	N	NSM8XSLFSLOT	N
AZ5600	D750GB7.2KS	N	N	N	NSM8XSLFSLOT	N
AZ5600	D750GB7.2KS	N	N	N	NSM8XSLFSLOT	N
AZ5600	D750GB7.2KS	N	N	N	NSM8XSLFSLOT	N

Model Name	HDD 1 (GB)	HDD 2 (GB)	HDD 3 (GB)	HDD 4 (GB)	ODD1	ODD2
AZ5600	D750GB7.2KS	N	N	N	NSM8XSLFSLOT	N
AZ5600	D750GB7.2KS	N	N	N	NSM8XSLFSLOT	N
AZ5600	D750GB7.2KS	N	N	N	NSM8XSLFSLOT	N
AZ5600	D750GB7.2KS	N	N	N	NSM8XSLFSLOT	N
AZ5600	D750GB7.2KS	N	N	N	NSM8XSLFSLOT	N
AZ5600	D750GB7.2KS	N	N	N	NSM8XSLFSLOT	N
AZ5600	D750GB7.2KS	N	N	N	NSM8XSLFSLOT	N
AZ5600	D750GB7.2KS	N	N	N	NSM8XSLFSLOT	N
AZ5600	D750GB7.2KS	N	N	N	NSM8XSLFSLOT	N
AZ5600	D750GB7.2KS	N	N	N	NSM8XSLFSLOT	N
AZ5600	D750GB7.2KS	N	N	N	NSM8XSLFSLOT	N
AZ5600	D750GB7.2KS	N	N	N	NSM8XSLFSLOT	N
AZ5600	D640GB7.2KS	N	N	N	NSM8XSLFSLOT	N
AZ5600	D1000GB7.2KS	N	N	N	N	N
AZ5600	D640GB7.2KS	N	N	N	N	N
AZ5600	D640GB7.2KS	N	N	N	N	N
AZ5600	D640GB7.2KS	N	N	N	N	N
AZ5600	D750GB7.2KS	N	N	N	N	N
AZ5600	D750GB7.2KS	N	N	N	N	N
AZ5610	D1500GB7.2KS	N	N	N	NSM8XSLFSLOT	N
AZ5610	D1000GB7.2KS	N	N	N	NSM8XSLFSLOT	N
AZ5610	D1000GB7.2KS	N	N	N	NSM8XSLFSLOT	N
AZ5610	D1000GB7.2KS	N	N	N	NSM8XSLFSLOT	N
AZ5610	D640GB7.2KS	N	N	N	NSM8XSLFSLOT	N
AZ5610	D640GB7.2KS	N	N	N	NSM8XSLFSLOT	N
AZ5610	D750GB7.2KS	N	N	N	NSM8XSLFSLOT	N
AZ5610	D750GB7.2KS	N	N	N	NSM8XSLFSLOT	N
AZ5610	D1000GB7.2KS	N	N	N	NSM8XSLFSLOT	N
AZ5610	D640GB7.2KS	N	N	N	NSM8XSLFSLOT	N
AZ5610	D640GB7.2KS	N	N	N	NSM8XSLFSLOT	N
AZ5610	D320GB7.2KS	N	N	N	NSM8XSLFSLOT	N
AZ5610	D1000GB7.2KS	N	N	N	NSM8XSLFSLOT	N
AZ5610	D750GB7.2KS	N	N	N	NSM8XSLFSLOT	N
AZ5610	D1500GB7.2KS	N	N	N	NSM8XSLFSLOT	N
AZ5610	D1000GB7.2KS	N	N	N	NSM8XSLFSLOT	N
AZ5610	D1000GB7.2KS	N	N	N	NSM8XSLFSLOT	N
AZ5610	D1000GB7.2KS	N	N	N	NSM8XSLFSLOT	N
AZ5610	D1500GB7.2KS	N	N	N	NSM8XSLFSLOT	N
AZ5610	D1500GB7.2KS	N	N	N	NSM8XSLFSLOT	N
AZ5610	D750GB7.2KS	N	N	N	NSM8XSLFSLOT	N
AZ5610	D750GB7.2KS	N	N	N	NSM8XSLFSLOT	N

Model Name	HDD 1 (GB)	HDD 2 (GB)	HDD 3 (GB)	HDD 4 (GB)	ODD1	ODD2
AZ5610	D750GB7.2KS	N	N	N	NSM8XSLFSLOT	N
AZ5610	D1000GB7.2KS	SSD25 64	N	N	NSM8XSLFSLOT	N
AZ5610	D1000GB7.2KS	SSD25 64	N	N	NSM8XSLFSLOT	N
AZ5610	D1000GB7.2KS	N	N	N	NSM8XSLFSLOT	N
AZ5610	D1000GB7.2KS	N	N	N	NBDCB4XSSLOT	N
AZ5610	D750GB7.2KS	N	N	N	NSM8XSLFSLOT	N
AZ5610	D750GB7.2KS	N	N	N	NSM8XSLFSLOT	N
AZ5610	D750GB7.2KS	N	N	N	NSM8XSLFSLOT	N
AZ5610	D750GB7.2KS	N	N	N	NSM8XSLFSLOT	N
AZ5610	D1000GB7.2KS	N	N	N	NSM8XSLFSLOT	N
AZ5610	D1000GB7.2KS	N	N	N	NSM8XSLFSLOT	N
AZ5610	D1000GB7.2KS	N	N	N	NBDCB4XSSLOT	N
AZ5610	D1000GB7.2KS	N	N	N	NBDCB4XSSLOT	N
AZ5610	D1000GB7.2KS	N	N	N	NSM8XSLFSLOT	N
AZ5610	D1000GB7.2KS	N	N	N	NBDCB4XSSLOT	N
AZ5610	D1000GB7.2KS	N	N	N	NBDCB4XSSLOT	N
AZ5610	D1000GB7.2KS	N	N	N	NBDCB4XSSLOT	N
AZ5610	D1000GB7.2KS	N	N	N	NBDCB4XSSLOT	N
AZ5610	D1000GB7.2KS	N	N	N	NBDCB4XSSLOT	N
AZ5610	D750GB7.2KS	N	N	N	NSM8XSLFSLOT	N
AZ5610	D750GB7.2KS	N	N	N	NSM8XSLFSLOT	N
AZ5610	D1000GB7.2KS	N	N	N	NSM8XSLFSLOT	N
AZ5610	D1000GB7.2KS	N	N	N	NSM8XSLFSLOT	N
AZ5610	D1000GB7.2KS	N	N	N	NSM8XSLFSLOT	N
AZ5610	D1000GB7.2KS	N	N	N	NSM8XSLFSLOT	N
AZ5610	D1000GB7.2KS	N	N	N	NSM8XSLFSLOT	N
AZ5610	D1000GB7.2KS	N	N	N	NSM8XSLFSLOT	N
AZ5610	D1000GB7.2KS	N	N	N	NSM8XSLFSLOT	N
AZ5610	D1000GB7.2KS	N	N	N	NSM8XSLFSLOT	N
AZ5610	D1000GB7.2KS	N	N	N	NSM8XSLFSLOT	N
AZ5610	D1000GB7.2KS	N	N	N	NSM8XSLFSLOT	N
AZ5610	D1000GB7.2KS	N	N	N	NBDCB4XSSLOT	N
AZ5610	D640GB7.2KS	N	N	N	NSM8XSLFSLOT	N
AZ5610	D1000GB7.2KS	N	N	N	NSM8XSLFSLOT	N
AZ5610	D750GB7.2KS	N	N	N	NBDCB4XSSLOT	N
AZ5610	D500GB7.2KS	N	N	N	NSM8XSLFSLOT	N
AZ5610	D500GB7.2KS	N	N	N	NSM8XSLFSLOT	N
AZ5610	D1000GB7.2KS	N	N	N	NSM8XSLFSLOT	N
AZ5610	D1000GB7.2KS	N	N	N	NSM8XSLFSLOT	N
AZ5610	D1000GB7.2KS	N	N	N	NSM8XSLFSLOT	N
AZ5610	D1000GB7.2KS	N	N	N	NSM8XSLFSLOT	N
AZ5610	D500GB7.2KS	N	N	N	NSM8XSLFSLOT	N

Model Name	HDD 1 (GB)	HDD 2 (GB)	HDD 3 (GB)	HDD 4 (GB)	ODD1	ODD2
AZ5610	D750GB7.2KS	N	N	N	NSM8XSLFSLOT	N
AZ5610	D750GB7.2KS	N	N	N	NSM8XSLFSLOT	N
AZ5610	D750GB7.2KS	N	N	N	NSM8XSLFSLOT	N
AZ5610	D750GB7.2KS	N	N	N	NSM8XSLFSLOT	N
AZ5610	D750GB7.2KS	N	N	N	NSM8XSLFSLOT	N
AZ5610	D750GB7.2KS	N	N	N	NSM8XSLFSLOT	N
AZ5610	D750GB7.2KS	N	N	N	NSM8XSLFSLOT	N
AZ5610	D750GB7.2KS	N	N	N	NSM8XSLFSLOT	N
AZ5610	D320GB7.2KS	N	N	N	NSM8XSLFSLOT	N
AZ5610	D1000GB7.2KS	N	N	N	NSM8XSLFSLOT	N
AZ5610	D1000GB7.2KS	N	N	N	NSM8XSLFSLOT	N
AZ5610	D1000GB7.2KS	N	N	N	NSM8XSLFSLOT	N
AZ5610	D1000GB7.2KS	N	N	N	NSM8XSLFSLOT	N
AZ5610	D1000GB7.2KS	N	N	N	NSM8XSLFSLOT	N
AZ5610	D1000GB7.2KS	N	N	N	NSM8XSLFSLOT	N
AZ5610	D1000GB7.2KS	N	N	N	NSM8XSLFSLOT	N
AZ5610	D1000GB7.2KS	N	N	N	NSM8XSLFSLOT	N
AZ5610	D1000GB7.2KS	N	N	N	NSM8XSLFSLOT	N
AZ5610	D1000GB7.2KS	N	N	N	NSM8XSLFSLOT	N
AZ5610	D1000GB7.2KS	N	N	N	NSM8XSLFSLOT	N
AZ5610	D1000GB7.2KS	N	N	N	NSM8XSLFSLOT	N
AZ5610	D1000GB7.2KS	N	N	N	NSM8XSLFSLOT	N
AZ5610	D1000GB7.2KS	N	N	N	NSM8XSLFSLOT	N
AZ5610	D1000GB7.2KS	N	N	N	NSM8XSLFSLOT	N
AZ5610	D1000GB7.2KS	N	N	N	NSM8XSLFSLOT	N
AZ5610	D1000GB7.2KS	N	N	N	NSM8XSLFSLOT	N
AZ5610	D1000GB7.2KS	N	N	N	NSM8XSLFSLOT	N
AZ5610	D1000GB7.2KS	N	N	N	NSM8XSLFSLOT	N
AZ5610	D1000GB7.2KS	N	N	N	NSM8XSLFSLOT	N
AZ5610	D1000GB7.2KS	N	N	N	NSM8XSLFSLOT	N
AZ5610	D1000GB7.2KS	N	N	N	NSM8XSLFSLOT	N
AZ5610	D1000GB7.2KS	N	N	N	NSM8XSLFSLOT	N
AZ5610	D1000GB7.2KS	N	N	N	NSM8XSLFSLOT	N
AZ5610	D1000GB7.2KS	N	N	N	NSM8XSLFSLOT	N
AZ5610	D1000GB7.2KS	N	N	N	NSM8XSLFSLOT	N
AZ5610	D1000GB7.2KS	N	N	N	NSM8XSLFSLOT	N
AZ5610	D1000GB7.2KS	N	N	N	NSM8XSLFSLOT	N
AZ5610	D640GB7.2KS	N	N	N	NSM8XSLFSLOT	N
AZ5610	D640GB7.2KS	N	N	N	NSM8XSLFSLOT	N
AZ5610	D640GB7.2KS	N	N	N	NSM8XSLFSLOT	N
AZ5610	D1000GB7.2KS	N	N	N	NSM8XSLFSLOT	N
AZ5610	D750GB7.2KS	N	N	N	NSM8XSLFSLOT	N

Model Name	HDD 1 (GB)	HDD 2 (GB)	HDD 3 (GB)	HDD 4 (GB)	ODD1	ODD2
AZ5610	D640GB7.2KS	N	N	N	NSM8XSLFSLOT	N
AZ5610	D750GB7.2KS	N	N	N	NSM8XSLFSLOT	N
AZ5610	D750GB7.2KS	N	N	N	NSM8XSLFSLOT	N
AZ5610	D750GB7.2KS	N	N	N	NSM8XSLFSLOT	N
AZ5610	D1000GB7.2KS	N	N	N	NSM8XSLFSLOT	N
AZ5610	D1000GB7.2KS	N	N	N	NSM8XSLFSLOT	N
AZ5610	D1000GB7.2KS	N	N	N	NSM8XSLFSLOT	N
AZ5610	D1000GB7.2KS	N	N	N	NSM8XSLFSLOT	N
AZ5610	D1000GB7.2KS	N	N	N	NSM8XSLFSLOT	N
AZ5610	D1000GB7.2KS	N	N	N	NSM8XSLFSLOT	N
AZ5610	D640GB7.2KS	N	N	N	NSM8XSLFSLOT	N
AZ5610	D640GB7.2KS	N	N	N	NSM8XSLFSLOT	N
AZ5610	D1000GB7.2KS	N	N	N	NSM8XSLFSLOT	N
AZ5610	D1000GB7.2KS	N	N	N	NSM8XSLFSLOT	N
AZ5610	D1000GB7.2KS	N	N	N	NSM8XSLFSLOT	N
AZ5610	D1000GB7.2KS	N	N	N	NSM8XSLFSLOT	N
AZ5610	D1000GB7.2KS	N	N	N	NSM8XSLFSLOT	N
AZ5610	D1000GB7.2KS	N	N	N	NSM8XSLFSLOT	N
AZ5610	D1000GB7.2KS	N	N	N	NSM8XSLFSLOT	N
AZ5610	D1000GB7.2KS	N	N	N	NSM8XSLFSLOT	N
AZ5610	D1000GB7.2KS	N	N	N	NSM8XSLFSLOT	N
AZ5610	D1000GB7.2KS	N	N	N	NSM8XSLFSLOT	N

Model Name	LCD	VGA Card 1	VGA Card 2	VGA Card 3	Modem	TV Tuner
AZ5600	D23FHD	N	N	N	N	N
AZ5600	D23FHD	N	N	N	N	N
AZ5600	D23FHD	N	N	N	N	mCard/SW/DVB-T
AZ5600	D23FHD	N	N	N	N	mCard/SW/DVB-T
AZ5600	D23FHD	N	N	N	N	N
AZ5600	D23FHD	N	N	N	N	N
AZ5600	D23FHD	N	N	N	N	N
AZ5600	D23FHD	N	N	N	N	N
AZ5600	D23FHD	N	N	N	N	N
AZ5600	D23FHD	N	N	N	N	N
AZ5600	D23FHD	N	N	N	N	N
AZ5600	D23FHD	N	N	N	N	N
AZ5600	D23FHD	N	N	N	N	N
AZ5600	D23FHD	N	N	N	N	N
AZ5600	D23FHD	N	N	N	N	N
AZ5600	D23FHD	N	N	N	N	N
AZ5600	D23FHD	N	N	N	N	N
AZ5600	D23FHD	N	N	N	N	N
AZ5600	D23FHD	N	N	N	N	N
AZ5600	D23FHD	N	N	N	N	N
AZ5600	D23FHD	N	N	N	N	N

Model Name	LCD	VGA Card 1	VGA Card 2	VGA Card 3	Modem	TV Tuner
AZ5600	D23FHD	N	N	N	N	N
AZ5600	D23FHD	N	N	N	N	N
AZ5600	D23FHD	N	N	N	N	N
AZ5600	D23FHD	N	N	N	N	N
AZ5600	D23FHD	N	N	N	N	N
AZ5600	D23FHD	N	N	N	N	N
AZ5600	D23FHD	N	N	N	N	N
AZ5600	D23FHD	N	N	N	N	N
AZ5600	D23FHD	N	N	N	N	N
AZ5600	D23FHD	N	N	N	N	N
AZ5600	D23FHD	N	N	N	N	N
AZ5600	D23FHD	N	N	N	N	N
AZ5600	D23FHD	N	N	N	N	N
AZ5600	D23FHD	N	N	N	N	N
AZ5600	D23FHD	N	N	N	N	N
AZ5600	D23FHD	N	N	N	N	N
AZ5600	D23FHD	N	N	N	N	N
AZ5600	D23FHD	N	N	N	N	N
AZ5600	D23FHD	N	N	N	N	N
AZ5600	D23FHD	N	N	N	N	N
AZ5600	D23FHD	N	N	N	N	N
AZ5600	D23FHD	M96XT_1024M	N	N	N	mPCI/SW/ATSC
AZ5600	D23FHD	N	N	N	N	mPCI/SW/ATSC
AZ5600	D23FHD	N	N	N	N	mPCI/SW/ATSC
AZ5600	D23FHD	N	N	N	N	mPCI/SW/ATSC
AZ5600	N	M92XT_512M	N	N	N	mPCI/SW/ATSC
AZ5600	N	M92XT_512M	N	N	N	mPCI/SW/ATSC
AZ5610	D23FHD	ATI HD4670 D3 1GB Type A	N	N	N	mCard/SW/DVB-T
AZ5610	D23FHD	ATI HD4570 D2 512MB-Santana Type A	N	N	N	mCard/SW/DVB-T
AZ5610	D23FHD	ATI HD4570 D2 512MB-Santana Type A	N	N	N	mCard/SW/DVB-T
AZ5610	D23FHD	ATI HD4570 D2 512MB-Santana Type A	N	N	N	mCard/SW/DVB-T
AZ5610	D23FHD	ATI HD4570 D2 512MB-Santana Type A	N	N	N	mCard/SW/DVB-T
AZ5610	D23FHD	ATI HD4570 D2 512MB-Santana Type A	N	N	N	mCard/SW/DVB-T

Model Name	LCD	VGA Card 1	VGA Card 2	VGA Card 3	Modem	TV Tuner
AZ5610	D23FHD	ATI HD4570 D2 512MB-Santana Type A	N	N	N	mCard/SW/DVB-T
AZ5610	D23FHD	ATI HD4570 D2 512MB-Santana Type A	N	N	N	mCard/SW/DVB-T
AZ5610	D23FHD	ATI HD4570 D2 512MB-Santana Type A	N	N	N	mCard/SW/DVB-T
AZ5610	D23FHD	ATI HD4570 D2 512MB-Santana Type A	N	N	N	mCard/SW/DVB-T
AZ5610	D23FHD	ATI HD4670 D3 1GB Type A	N	N	N	mCard/SW/DVB-T
AZ5610	D23FHD	ATI HD4570 D2 512MB-Santana Type A	N	N	N	N
AZ5610	D23FHD	ATI HD4670 D3 1GB Type A	N	N	N	mCard/SW/DVB-T
AZ5610	D23FHD	ATI HD4570 D2 512MB-Santana Type A	N	N	N	mCard/SW/DVB-T
AZ5610	D23FHD	ATI HD4670 D3 1GB Type A	N	N	N	N
AZ5610	D23FHD	ATI HD4570 D2 512MB-Santana Type A	N	N	N	mCard/SW/DVB-T
AZ5610	D23FHD	ATI HD4570 D2 512MB-Santana Type A	N	N	N	mCard/SW/DVB-T
AZ5610	D23FHD	ATI HD4570 D2 512MB-Santana Type A	N	N	N	mCard/SW/DVB-T
AZ5610	D23FHD	ATI HD4570 D2 512MB-Santana Type A	N	N	N	mCard/SW/DVB-T
AZ5610	D23FHD	ATI HD4570 D2 512MB-Santana Type A	N	N	N	mCard/SW/DVB-T
AZ5610	D23FHD	ATI HD4570 D2 512MB-Santana Type A	N	N	N	mCard/SW/DVB-T
AZ5610	D23FHD	ATI HD4570 D2 512MB-Santana Type A	N	N	N	mCard/SW/DVB-T
AZ5610	D23FHD	ATI HD4570 D2 512MB-Santana Type A	N	N	N	mCard/SW/DVB-T
AZ5610	D23FHD	ATI HD4570 D2 512MB-Santana Type A	N	N	N	mCard/SW/DVB-T
AZ5610	D23FHD	ATI HD4570 D2 512MB-Santana Type A	N	N	N	mCard/SW/DVB-T
AZ5610	D23FHD	ATI HD4570 D2 512MB-Santana Type A	N	N	N	mCard/SW/DVB-T
AZ5610	D23FHD	ATI HD4570 D2 512MB-Santana Type A	N	N	N	mCard/SW/DVB-T

Model Name	LCD	VGA Card 1	VGA Card 2	VGA Card 3	Modem	TV Tuner
AZ5610	D23FHD	ATI HD4570 D2 512MB-Santana Type A	N	N	N	mCard/SW/DVB-T
AZ5610	D23FHD	ATI HD4570 D2 512MB-Santana Type A	N	N	N	N
AZ5610	D23FHD	ATI HD4670 D3 1GB Type A	N	N	N	mCard/SW/DVB-T
AZ5610	D23FHD	ATI HD4570 D2 512MB-Santana Type A	N	N	N	mCard/SW/DVB-T
AZ5610	D23FHD	ATI HD4570 D2 512MB-Santana Type A	N	N	N	mCard/SW/DVB-T
AZ5610	D23FHD	ATI HD4570 D2 512MB-Santana Type A	N	N	N	mCard/SW/DVB-T
AZ5610	D23FHD	ATI HD4570 D2 512MB-Santana Type A	N	N	N	mCard/SW/DVB-T
AZ5610	D23FHD	ATI HD4570 D2 512MB-Santana Type A	N	N	N	mCard/SW/DVB-T
AZ5610	D23FHD	ATI HD4570 D2 512MB-Santana Type A	N	N	N	mCard/SW/DVB-T
AZ5610	D23FHD	ATI HD4670 D3 1GB Type A	N	N	N	mCard/SW/DVB-T
AZ5610	D23FHD	ATI HD4670 D3 1GB Type A	N	N	N	mCard/SW/DVB-T
AZ5610	D23FHD	ATI HD4670 D3 1GB Type A	N	N	N	mCard/SW/DVB-T
AZ5610	D23FHD	ATI HD4570 D2 512MB-Santana Type A	N	N	N	mCard/SW/DVB-T
AZ5610	D23FHD	ATI HD4670 D3 1GB Type A	N	N	N	mCard/SW/DVB-T
AZ5610	D23FHD	ATI HD4670 D3 1GB Type A	N	N	N	mCard/SW/DVB-T
AZ5610	D23FHD	ATI HD4670 D3 1GB Type A	N	N	N	mCard/SW/DVB-T
AZ5610	D23FHD	ATI HD4670 D3 1GB Type A	N	N	N	mCard/SW/DVB-T
AZ5610	D23FHD	ATI HD4570 D2 512MB-Santana Type A	N	N	N	mCard/SW/DVB-T
AZ5610	D23FHD	ATI HD4570 D2 512MB-Santana Type A	N	N	N	mCard/SW/DVB-T

Model Name	LCD	VGA Card 1	VGA Card 2	VGA Card 3	Modem	TV Tuner
AZ5610	D23FHD	ATI HD4570 D2 512MB-Santana Type A	N	N	N	mCard/SW/DVB-T
AZ5610	D23FHD	ATI HD4570 D2 512MB-Santana Type A	N	N	N	mCard/SW/DVB-T
AZ5610	D23FHD	ATI HD4570 D2 512MB-Santana Type A	N	N	N	mCard/SW/DVB-T
AZ5610	D23FHD	ATI HD4570 D2 512MB-Santana Type A	N	N	N	mCard/SW/DVB-T
AZ5610	D23FHD	ATI HD4570 D2 512MB-Santana Type A	N	N	N	mCard/SW/DVB-T
AZ5610	D23FHD	ATI HD4570 D2 512MB-Santana Type A	N	N	N	mCard/SW/DVB-T
AZ5610	D23FHD	ATI HD4570 D2 512MB-Santana Type A	N	N	N	mCard/SW/DVB-T
AZ5610	D23FHD	ATI HD4570 D2 512MB-Santana Type A	N	N	N	mCard/SW/DVB-T
AZ5610	D23FHD	ATI HD4670 D3 1GB Type A	N	N	N	mCard/SW/DVB-T
AZ5610	D23FHD	ATI HD4670 D3 1GB Type A	N	N	N	mCard/SW/DVB-T
AZ5610	D23FHD	ATI HD4570 D2 512MB-Santana Type A	N	N	N	mCard/SW/DVB-T
AZ5610	D23FHD	ATI HD4670 D3 1GB Type A	N	N	N	N
AZ5610	D23FHD	ATI HD4570 D2 512MB-Santana Type A	N	N	N	N
AZ5610	D23FHD	ATI HD4570 D2 512MB-Santana Type A	N	N	N	N
AZ5610	D23FHD	ATI HD4570 D2 512MB-Santana Type A	N	N	N	mCard/SW/DVB-T
AZ5610	D23FHD	ATI HD4570 D2 512MB-Santana Type A	N	N	N	mCard/SW/DVB-T
AZ5610	D23FHD	ATI HD4570 D2 512MB-Santana Type A	N	N	N	mCard/SW/DVB-T

Model Name	LCD	VGA Card 1	VGA Card 2	VGA Card 3	Modem	TV Tuner
AZ5610	D23FHD	ATI HD4670 D3 1GB Type A	N	N	N	N
AZ5610	D23FHD	ATI HD4570 D2 512MB-Santana Type A	N	N	N	N
AZ5610	D23FHD	ATI HD4570 D2 512MB-Santana Type A	N	N	N	N
AZ5610	D23FHD	ATI HD4570 D2 512MB-Santana Type A	N	N	N	N
AZ5610	D23FHD	ATI HD4570 D2 512MB-Santana Type A	N	N	N	N
AZ5610	D23FHD	ATI HD4570 D2 512MB-Santana Type A	N	N	N	N
AZ5610	D23FHD	ATI HD4570 D2 512MB-Santana Type A	N	N	N	N
AZ5610	D23FHD	ATI HD4570 D2 512MB-Santana Type A	N	N	N	mCard/SW/DVB-T
AZ5610	D23FHD	ATI HD4570 D2 512MB-Santana Type A	N	N	N	mCard/SW/DVB-T
AZ5610	D23FHD	ATI HD4570 D2 512MB-Santana Type A	N	N	N	mCard/SW/DVB-T
AZ5610	D23FHD	ATI HD4570 D2 512MB-Santana Type A	N	N	N	N
AZ5610	D23FHD	ATI HD4570 D2 512MB-Santana Type A	N	N	N	mCard/SW/ISDB-S
AZ5610	D23FHD	ATI HD4570 D2 512MB-Santana Type A	N	N	N	N
AZ5610	D23FHD	ATI HD4570 D2 512MB-Santana Type A	N	N	N	N
AZ5610	D23FHD	ATI HD4570 D2 512MB-Santana Type A	N	N	N	N
AZ5610	D23FHD	ATI HD4570 D2 512MB-Santana Type A	N	N	N	N
AZ5610	D23FHD	ATI HD4570 D2 512MB-Santana Type A	N	N	N	N

Model Name	LCD	VGA Card 1	VGA Card 2	VGA Card 3	Modem	TV Tuner
AZ5610	D23FHD	ATI HD4570 D2 512MB-Santana Type A	N	N	N	N
AZ5610	D23FHD	ATI HD4570 D2 512MB-Santana Type A	N	N	N	mCard/SW/DVB-T
AZ5610	D23FHD	ATI HD4570 D2 512MB-Santana Type A	N	N	N	mCard/SW/DVB-T
AZ5610	D23FHD	ATI HD4570 D2 512MB-Santana Type A	N	N	N	mCard/SW/DVB-T
AZ5610	D23FHD	ATI HD4670 D3 1GB Type A	N	N	N	mCard/SW/DVB-T
AZ5610	D23FHD	ATI HD4670 D3 1GB Type A	N	N	N	mCard/SW/DVB-T
AZ5610	D23FHD	ATI HD4670 D3 1GB Type A	N	N	N	mCard/SW/DVB-T
AZ5610	D23FHD	ATI HD4570 D2 512MB-Santana Type A	N	N	N	N
AZ5610	D23FHD	ATI HD4570 D2 512MB-Santana Type A	N	N	N	N
AZ5610	D23FHD	ATI HD4670 D3 1GB Type A	N	N	N	N
AZ5610	D23FHD	ATI HD4570 D2 512MB-Santana Type A	N	N	N	N
AZ5610	D23FHD	ATI HD4570 D2 512MB-Santana Type A	N	N	N	N
AZ5610	D23FHD	ATI HD4570 D2 512MB-Santana Type A	N	N	N	N
AZ5610	D23FHD	ATI HD4570 D2 512MB-Santana Type A	N	N	N	N
AZ5610	D23FHD	ATI HD4570 D2 512MB-Santana Type A	N	N	N	N
AZ5610	D23FHD	ATI HD4570 D2 512MB-Santana Type A	N	N	N	N
AZ5610	D23FHD	ATI HD4570 D2 512MB-Santana Type A	N	N	N	N
AZ5610	D23FHD	ATI HD4570 D2 512MB-Santana Type A	N	N	N	N
AZ5610	D23FHD	ATI HD4570 D2 512MB-Santana Type A	N	N	N	N

Model Name	LCD	VGA Card 1	VGA Card 2	VGA Card 3	Modem	TV Tuner
AZ5610	D23FHD	ATI HD4570 D2 512MB-Santana Type A	N	N	N	N
AZ5610	D23FHD	ATI HD4570 D2 512MB-Santana Type A	N	N	N	N
AZ5610	D23FHD	ATI HD4570 D2 512MB-Santana Type A	N	N	N	N
AZ5610	D23FHD	ATI HD4570 D2 512MB-Santana Type A	N	N	N	N
AZ5610	D23FHD	ATI HD4570 D2 512MB-Santana Type A	N	N	N	N
AZ5610	D23FHD	ATI HD4570 D2 512MB-Santana Type A	N	N	N	N
AZ5610	D23FHD	ATI HD4570 D2 512MB-Santana Type A	N	N	N	N
AZ5610	D23FHD	ATI HD4570 D2 512MB-Santana Type A	N	N	N	N
AZ5610	D23FHD	ATI HD4570 D2 512MB-Santana Type A	N	N	N	N
AZ5610	D23FHD	ATI HD4570 D2 512MB-Santana Type A	N	N	N	N
AZ5610	D23FHD	ATI HD4570 D2 512MB-Santana Type A	N	N	N	N
AZ5610	D23FHD	ATI HD4570 D2 512MB-Santana Type A	N	N	N	N
AZ5610	D23FHD	ATI HD4570 D2 512MB-Santana Type A	N	N	N	N
AZ5610	D23FHD	ATI HD4570 D2 512MB-Santana Type A	N	N	N	N
AZ5610	D23FHD	ATI HD4570 D2 512MB-Santana Type A	N	N	N	N
AZ5610	D23FHD	ATI HD4570 D2 512MB-Santana Type A	N	N	N	N
AZ5610	D23FHD	ATI HD4570 D2 512MB-Santana Type A	N	N	N	N
AZ5610	D23FHD	ATI HD4570 D2 512MB-Santana Type A	N	N	N	N

Model Name	LCD	VGA Card 1	VGA Card 2	VGA Card 3	Modem	TV Tuner
AZ5610	D23FHD	ATI HD4570 D2 512MB-Santana Type A	N	N	N	N
AZ5610	D23FHD	ATI HD4570 D2 512MB-Santana Type A	N	N	N	N
AZ5610	D23FHD	ATI HD4570 D2 512MB-Santana Type A	N	N	N	N
AZ5610	D23FHD	ATI HD4570 D2 512MB-Santana Type A	N	N	N	N
AZ5610	D23FHD	ATI HD4570 D2 512MB-Santana Type A	N	N	N	N
AZ5610	D23FHD	ATI HD4570 D2 512MB-Santana Type A	N	N	N	N
AZ5610	D23FHD	ATI HD4570 D2 512MB-Santana Type A	N	N	N	N
AZ5610	D23FHD	ATI HD4570 D2 512MB-Santana Type A	N	N	N	N
AZ5610	D23FHD	ATI HD4570 D2 512MB-Santana Type A	N	N	N	N
AZ5610	D23FHD	ATI HD4570 D2 512MB-Santana Type A	N	N	N	N
AZ5610	D23FHD	ATI HD4670 D3 1GB Type A	N	N	N	N
AZ5610	D23FHD	ATI HD4670 D3 1GB Type A	N	N	N	N
AZ5610	D23FHD	ATI HD4670 D3 1GB Type A	N	N	N	N

Model Name	Add on card 1	Add on card 2	Remote control	RC Receiver	Keyboard	Mouse	Speaker
AZ5600	802.11 b/g/n (mini-card)	N	N	N	RF2.4/0812	RF2.4/0812	N
AZ5600	802.11 b/g/n (mini-card)	N	N	N	RF2.4/0812	RF2.4/0812	N
AZ5600	802.11 b/g/n (mini-card)	N	US Win7 WMC	N	RF2.4/0812	RF2.4/0812	N
AZ5600	802.11 b/g/n (mini-card)	N	US Win7 WMC	N	RF2.4/0812	RF2.4/0812	N
AZ5600	802.11 b/g/n (mini-card)	Bluetooth	N	N	RF2.4/0812	RF2.4/0812	N

Model Name	Add on card 1	Add on card 2	Remote control	RC Receiver	Keyboard	Mouse	Speaker
AZ5600	802.11 b/g/n (mini-card)	Bluetooth	N	N	RF2.4/0812	RF2.4/0812	N
AZ5600	802.11 b/g/n (mini-card)	Bluetooth	N	N	RF2.4/0812	RF2.4/0812	N
AZ5600	802.11 b/g/n (mini-card)	N	N	N	RF2.4/0812	RF2.4/0812	N
AZ5600	802.11 b/g/n (mini-card)	N	N	N	RF2.4/0812	RF2.4/0812	N
AZ5600	Bluetooth	802.11 b/g/n (mini-card)	N	N	RF2.4/0812	RF2.4/0812	N
AZ5600	802.11 b/g/n (mini-card)	Bluetooth	N	N	RF2.4/0812	RF2.4/0812	N
AZ5600	802.11 b/g/n (mini-card)	Bluetooth	N	N	RF2.4/0812	RF2.4/0812	N
AZ5600	802.11 b/g/n (mini-card)	Bluetooth	N	N	RF2.4/0812	RF2.4/0812	N
AZ5600	802.11 b/g/n (mini-card)	Bluetooth	N	N	RF2.4/0812	RF2.4/0812	N
AZ5600	802.11 b/g/n (mini-card)	Bluetooth	N	N	RF2.4/0812	RF2.4/0812	N
AZ5600	802.11 b/g/n (mini-card)	Bluetooth	N	N	RF2.4/0812	RF2.4/0812	N
AZ5600	802.11 b/g/n (mini-card)	Bluetooth	N	N	RF2.4/0812	RF2.4/0812	N
AZ5600	802.11 b/g/n (mini-card)	Bluetooth	N	N	RF2.4/0812	RF2.4/0812	N
AZ5600	802.11 b/g/n (mini-card)	Bluetooth	N	N	RF2.4/0812	RF2.4/0812	N
AZ5600	802.11 b/g/n (mini-card)	Bluetooth	N	N	RF2.4/0812	RF2.4/0812	N
AZ5600	802.11 b/g/n (mini-card)	Bluetooth	N	N	RF2.4/0812	RF2.4/0812	N
AZ5600	802.11 b/g/n (mini-card)	Bluetooth	N	N	RF2.4/0812	RF2.4/0812	N
AZ5600	802.11 b/g/n (mini-card)	Bluetooth	N	N	RF2.4/0812	RF2.4/0812	N
AZ5600	802.11 b/g/n (mini-card)	Bluetooth	N	N	RF2.4/0812	RF2.4/0812	N
AZ5600	802.11 b/g/n (mini-card)	Bluetooth	N	N	RF2.4/0812	RF2.4/0812	N
AZ5600	802.11 b/g/n (mini-card)	Bluetooth	N	N	RF2.4/0812	RF2.4/0812	N
AZ5600	802.11 b/g/n (mini-card)	Bluetooth	N	N	RF2.4/0812	RF2.4/0812	N
AZ5600	802.11 b/g/n (mini-card)	Bluetooth	N	N	RF2.4/0812	RF2.4/0812	N
AZ5600	802.11 b/g/n (mini-card)	Bluetooth	N	N	RF2.4/0812	RF2.4/0812	N
AZ5600	802.11 b/g/n (mini-card)	Bluetooth	N	N	RF2.4/0812	RF2.4/0812	N
AZ5600	802.11 b/g/n (mini-card)	Bluetooth	N	N	RF2.4/0812	RF2.4/0812	N
AZ5600	802.11 b/g/n (mini-card)	Bluetooth	N	N	RF2.4/0812	RF2.4/0812	N

Model Name	Add on card 1	Add on card 2	Remote control	RC Receiver	Keyboard	Mouse	Speaker
AZ5600	802.11 b/g/n (mini-card)	Bluetooth	N	N	RF2.4/0812	RF2.4/0812	N
AZ5600	802.11 b/g/n (mini-card)	Bluetooth	N	N	RF2.4/0812	RF2.4/0812	N
AZ5600	802.11 b/g/n (mini-card)	Bluetooth	N	N	RF2.4/0812	RF2.4/0812	N
AZ5600	802.11 b/g/n (mini-card)	Bluetooth	N	N	RF2.4/0812	RF2.4/0812	N
AZ5600	802.11 b/g/n (mini-card)	Bluetooth	N	N	RF2.4/0812	RF2.4/0812	N
AZ5600	802.11 b/g/n (mini-card)	Bluetooth	N	N	RF2.4/0812	RF2.4/0812	N
AZ5600	802.11 b/g/n (mini-card)	Bluetooth	N	N	RF2.4/0812	RF2.4/0812	N
AZ5600	802.11 b/g/n (mini-card)	Bluetooth	N	N	RF2.4/0812	RF2.4/0812	N
AZ5600	802.11 b/g/n (mini-card)	Bluetooth	N	N	RF2.4/0812	RF2.4/0812	N
AZ5600	802.11 b/g/n (mini-card)	Bluetooth	N	N	RF2.4/0812	RF2.4/0812	N
AZ5600	Bluetooth	802.11 b/g/n (mini-card)	N	N	RF2.4/0812	RF2.4/0812	N
AZ5600	802.11 b/g/n (mini-card)	N	US Vista MCE	N	USB/0811	USB/0811	N
AZ5600	802.11 b/g/n (mini-card)	N	EMEA Vista MCE	N	USB/0811	USB/0811	N
AZ5600	802.11 b/g/n (mini-card)	N	EMEA Vista MCE	N	USB/0811	USB/0811	N
AZ5600	802.11 b/g/n (mini-card)	N	EMEA Vista MCE	N	USB/0811	USB/0811	N
AZ5600	802.11 b/g/n (mini-card)	N	N	N	USB/0811	USB/0811	N
AZ5600	802.11 b/g/n (mini-card)	N	N	N	USB/0811	USB/0811	N
AZ5610	802.11 b/g/n (mini-card)	Bluetooth	EMEA Win7 WMC	N	RF2.4/0812	RF2.4/0812	N
AZ5610	802.11 b/g/n (mini-card)	Bluetooth	EMEA Win7 WMC	N	RF2.4/0812	RF2.4/0812	N
AZ5610	802.11 b/g/n (mini-card)	Bluetooth	EMEA Win7 WMC	N	RF2.4/0812	RF2.4/0812	N
AZ5610	802.11 b/g/n (mini-card)	Bluetooth	EMEA Win7 WMC	N	RF2.4/0812	RF2.4/0812	N
AZ5610	802.11 b/g/n (mini-card)	Bluetooth	EMEA Win7 WMC	N	RF2.4/0812	RF2.4/0812	N

Model Name	Add on card 1	Add on card 2	Remote control	RC Receiver	Keyboard	Mouse	Speaker
AZ5610	802.11 b/g/n (mini-card)	Bluetooth	EMEA Win7 WMC	N	RF2.4/0812	RF2.4/0812	N
AZ5610	802.11 b/g/n (mini-card)	Bluetooth	EMEA Win7 WMC	N	RF2.4/0812	RF2.4/0812	N
AZ5610	802.11 b/g/n (mini-card)	Bluetooth	EMEA Win7 WMC	N	RF2.4/0812	RF2.4/0812	N
AZ5610	802.11 b/g/n (mini-card)	Bluetooth	EMEA Win7 WMC	N	RF2.4/0812	RF2.4/0812	N
AZ5610	802.11 b/g/n (mini-card)	Bluetooth	EMEA Win7 WMC	N	RF2.4/0812	RF2.4/0812	N
AZ5610	802.11 b/g/n (mini-card)	Bluetooth	EMEA Win7 WMC	N	RF2.4/0812	RF2.4/0812	N
AZ5610	802.11 b/g/n (mini-card)	Bluetooth	N	N	RF2.4/0812	RF2.4/0812	N
AZ5610	802.11 b/g/n (mini-card)	Bluetooth	EMEA Win7 WMC	N	RF2.4/0812	RF2.4/0812	N
AZ5610	802.11 b/g/n (mini-card)	Bluetooth	EMEA Win7 WMC	N	RF2.4/0812	RF2.4/0812	N
AZ5610	802.11 b/g/n (mini-card)	Bluetooth	N	N	RF2.4/0812	RF2.4/0812	N
AZ5610	802.11 b/g/n (mini-card)	Bluetooth	EMEA Win7 WMC	N	RF2.4/0812	RF2.4/0812	N
AZ5610	802.11 b/g/n (mini-card)	Bluetooth	EMEA Win7 WMC	N	RF2.4/0812	RF2.4/0812	N
AZ5610	802.11 b/g/n (mini-card)	Bluetooth	EMEA Win7 WMC	N	RF2.4/0812	RF2.4/0812	N
AZ5610	802.11 b/g/n (mini-card)	Bluetooth	EMEA Win7 WMC	N	RF2.4/0812	RF2.4/0812	N
AZ5610	802.11 b/g/n (mini-card)	Bluetooth	EMEA Win7 WMC	N	RF2.4/0812	RF2.4/0812	N
AZ5610	802.11 b/g/n (mini-card)	Bluetooth	EMEA Win7 WMC	N	RF2.4/0812	RF2.4/0812	N
AZ5610	802.11 b/g/n (mini-card)	Bluetooth	EMEA Win7 WMC	N	RF2.4/0812	RF2.4/0812	N

Model Name	Add on card 1	Add on card 2	Remote control	RC Receiver	Keyboard	Mouse	Speaker
AZ5610	802.11 b/g/n (mini-card)	Bluetooth	EMEA Win7 WMC	N	RF2.4/0812	RF2.4/0812	N
AZ5610	802.11 b/g/n (mini-card)	Bluetooth	EMEA Win7 WMC	N	RF2.4/0812	RF2.4/0812	N
AZ5610	802.11 b/g/n (mini-card)	Bluetooth	EMEA Win7 WMC	N	RF2.4/0812	RF2.4/0812	N
AZ5610	802.11 b/g/n (mini-card)	Bluetooth	EMEA Win7 WMC	N	RF2.4/0812	RF2.4/0812	N
AZ5610	802.11 b/g/n (mini-card)	Bluetooth	EMEA Win7 WMC	N	RF2.4/0812	RF2.4/0812	N
AZ5610	802.11 b/g/n (mini-card)	Bluetooth	EMEA Win7 WMC	N	RF2.4/0812	RF2.4/0812	N
AZ5610	802.11 b/g/n (mini-card)	Bluetooth	EMEA Win7 WMC	N	RF2.4/0812	RF2.4/0812	N
AZ5610	802.11 b/g/n (mini-card)	Bluetooth	EMEA Win7 WMC	N	RF2.4/0812	RF2.4/0812	N
AZ5610	802.11 b/g/n (mini-card)	Bluetooth	EMEA Win7 WMC	N	RF2.4/0812	RF2.4/0812	N
AZ5610	802.11 b/g/n (mini-card)	Bluetooth	EMEA Win7 WMC	N	RF2.4/0812	RF2.4/0812	N
AZ5610	802.11 b/g/n (mini-card)	Bluetooth	EMEA Win7 WMC	N	RF2.4/0812	RF2.4/0812	N
AZ5610	802.11 b/g/n (mini-card)	Bluetooth	EMEA Win7 WMC	N	RF2.4/0812	RF2.4/0812	N
AZ5610	802.11 b/g/n (mini-card)	Bluetooth	EMEA Win7 WMC	N	RF2.4/0812	RF2.4/0812	N
AZ5610	802.11 b/g/n (mini-card)	Bluetooth	EMEA Win7 WMC	N	RF2.4/0812	RF2.4/0812	N
AZ5610	802.11 b/g/n (mini-card)	Bluetooth	EMEA Win7 WMC	N	RF2.4/0812	RF2.4/0812	N
AZ5610	802.11 b/g/n (mini-card)	Bluetooth	EMEA Win7 WMC	N	RF2.4/0812	RF2.4/0812	N
AZ5610	802.11 b/g/n (mini-card)	Bluetooth	EMEA Win7 WMC	N	RF2.4/0812	RF2.4/0812	N
AZ5610	802.11 b/g/n (mini-card)	Bluetooth	EMEA Win7 WMC	N	RF2.4/0812	RF2.4/0812	N
AZ5610	802.11 b/g/n (mini-card)	Bluetooth	EMEA Win7 WMC	N	RF2.4/0812	RF2.4/0812	N

Model Name	Add on card 1	Add on card 2	Remote control	RC Receiver	Keyboard	Mouse	Speaker
AZ5610	802.11 b/g/n (mini-card)	Bluetooth	EMEA Win7 WMC	N	RF2.4/0812	RF2.4/0812	N
AZ5610	802.11 b/g/n (mini-card)	Bluetooth	EMEA Win7 WMC	N	RF2.4/0812	RF2.4/0812	N
AZ5610	802.11 b/g/n (mini-card)	Bluetooth	EMEA Win7 WMC	N	RF2.4/0812	RF2.4/0812	N
AZ5610	802.11 b/g/n (mini-card)	Bluetooth	EMEA Win7 WMC	N	RF2.4/0812	RF2.4/0812	N
AZ5610	802.11 b/g/n (mini-card)	Bluetooth	EMEA Win7 WMC	N	RF2.4/0812	RF2.4/0812	N
AZ5610	802.11 b/g/n (mini-card)	Bluetooth	EMEA Win7 WMC	N	RF2.4/0812	RF2.4/0812	N
AZ5610	802.11 b/g/n (mini-card)	Bluetooth	EMEA Win7 WMC	N	RF2.4/0812	RF2.4/0812	N
AZ5610	802.11 b/g/n (mini-card)	Bluetooth	EMEA Win7 WMC	N	RF2.4/0812	RF2.4/0812	N
AZ5610	802.11 b/g/n (mini-card)	Bluetooth	EMEA Win7 WMC	N	RF2.4/0812	RF2.4/0812	N
AZ5610	802.11 b/g/n (mini-card)	Bluetooth	EMEA Win7 WMC	N	RF2.4/0812	RF2.4/0812	N
AZ5610	802.11 b/g/n (mini-card)	Bluetooth	EMEA Win7 WMC	N	RF2.4/0812	RF2.4/0812	N
AZ5610	802.11 b/g/n (mini-card)	Bluetooth	EMEA Win7 WMC	N	RF2.4/0812	RF2.4/0812	N
AZ5610	802.11 b/g/n (mini-card)	Bluetooth	EMEA Win7 WMC	N	RF2.4/0812	RF2.4/0812	N
AZ5610	802.11 b/g/n (mini-card)	Bluetooth	EMEA Win7 WMC	N	RF2.4/0812	RF2.4/0812	N
AZ5610	802.11 b/g/n (mini-card)	Bluetooth	EMEA Win7 WMC	N	RF2.4/0812	RF2.4/0812	N
AZ5610	802.11 b/g/n (mini-card)	Bluetooth	EMEA Win7 WMC	N	RF2.4/0812	RF2.4/0812	N
AZ5610	802.11 b/g/n (mini-card)	Bluetooth	N	N	RF2.4/0812	RF2.4/0812	N
AZ5610	802.11 b/g/n (mini-card)	Bluetooth	N	N	RF2.4/0812	RF2.4/0812	N
AZ5610	802.11 b/g/n (mini-card)	Bluetooth	N	N	RF2.4/0812	RF2.4/0812	N

Model Name	Add on card 1	Add on card 2	Remote control	RC Receiver	Keyboard	Mouse	Speaker
AZ5610	802.11 b/g/n (mini-card)	Bluetooth	N	N	RF2.4/0812	RF2.4/0812	N
AZ5610	802.11 b/g/n (mini-card)	Bluetooth	US Win7 WMC	N	RF2.4/0812	RF2.4/0812	N
AZ5610	802.11 b/g/n (mini-card)	Bluetooth	US Win7 WMC	N	RF2.4/0812	RF2.4/0812	N
AZ5610	802.11 b/g/n (mini-card)	Bluetooth	US Win7 WMC	N	RF2.4/0812	RF2.4/0812	N
AZ5610	802.11 b/g/n (mini-card)	Bluetooth	N	N	RF2.4/0812	RF2.4/0812	N
AZ5610	802.11 b/g/n (mini-card)	Bluetooth	N	N	RF2.4/0812	RF2.4/0812	N
AZ5610	802.11 b/g/n (mini-card)	Bluetooth	N	N	RF2.4/0812	RF2.4/0812	N
AZ5610	802.11 b/g/n (mini-card)	Bluetooth	N	N	RF2.4/0812	RF2.4/0812	N
AZ5610	802.11 b/g/n (mini-card)	Bluetooth	N	N	RF2.4/0812	RF2.4/0812	N
AZ5610	802.11 b/g/n (mini-card)	Bluetooth	N	N	RF2.4/0812	RF2.4/0812	N
AZ5610	802.11 b/g/n (mini-card)	Bluetooth	N	N	RF2.4/0812	RF2.4/0812	N
AZ5610	802.11 b/g/n (mini-card)	Bluetooth	N	N	RF2.4/0812	RF2.4/0812	N
AZ5610	802.11 b/g/n (mini-card)	Bluetooth	N	N	RF2.4/0812	RF2.4/0812	N
AZ5610	802.11 b/g/n (mini-card)	N	N	N	RF2.4/0812	RF2.4/0812	N
AZ5610	802.11 b/g/n (mini-card)	Bluetooth	Japan Win7 WMC	N	RF2.4/0812	RF2.4/0812	N
AZ5610	802.11 b/g/n (mini-card)	Bluetooth	N	N	RF2.4/0812	RF2.4/0812	N
AZ5610	802.11 b/g/n (mini-card)	Bluetooth	N	N	RF2.4/0812	RF2.4/0812	N
AZ5610	802.11 b/g/n (mini-card)	Bluetooth	N	N	RF2.4/0812	RF2.4/0812	N
AZ5610	802.11 b/g/n (mini-card)	Bluetooth	N	N	RF2.4/0812	RF2.4/0812	N
AZ5610	802.11 b/g/n (mini-card)	Bluetooth	N	N	RF2.4/0812	RF2.4/0812	N
AZ5610	802.11 b/g/n (mini-card)	Bluetooth	N	N	RF2.4/0812	RF2.4/0812	N
AZ5610	802.11 b/g/n (mini-card)	Bluetooth	US Win7 WMC	N	RF2.4/0812	RF2.4/0812	N
AZ5610	802.11 b/g/n (mini-card)	Bluetooth	US Win7 WMC	N	RF2.4/0812	RF2.4/0812	N

Model Name	Add on card 1	Add on card 2	Remote control	RC Receiver	Keyboard	Mouse	Speaker
AZ5610	802.11 b/g/n (mini-card)	Bluetooth	US Win7 WMC	N	RF2.4/0812	RF2.4/0812	N
AZ5610	802.11 b/g/n (mini-card)	Bluetooth	US Win7 WMC	N	RF2.4/0812	RF2.4/0812	N
AZ5610	802.11 b/g/n (mini-card)	Bluetooth	US Win7 WMC	N	RF2.4/0812	RF2.4/0812	N
AZ5610	802.11 b/g/n (mini-card)	Bluetooth	US Win7 WMC	N	RF2.4/0812	RF2.4/0812	N
AZ5610	802.11 b/g/n (mini-card)	Bluetooth	N	N	RF2.4/0812	RF2.4/0812	N
AZ5610	802.11 b/g/n (mini-card)	Bluetooth	N	N	RF2.4/0812	RF2.4/0812	N
AZ5610	802.11 b/g/n (mini-card)	Bluetooth	N	N	RF2.4/0812	RF2.4/0812	N
AZ5610	802.11 b/g/n (mini-card)	Bluetooth	N	N	RF2.4/0812	RF2.4/0812	N
AZ5610	802.11 b/g/n (mini-card)	Bluetooth	N	N	RF2.4/0812	RF2.4/0812	N
AZ5610	802.11 b/g/n (mini-card)	Bluetooth	N	N	RF2.4/0812	RF2.4/0812	N
AZ5610	802.11 b/g/n (mini-card)	Bluetooth	N	N	RF2.4/0812	RF2.4/0812	N
AZ5610	802.11 b/g/n (mini-card)	Bluetooth	N	N	RF2.4/0812	RF2.4/0812	N
AZ5610	802.11 b/g/n (mini-card)	Bluetooth	N	N	RF2.4/0812	RF2.4/0812	N
AZ5610	802.11 b/g/n (mini-card)	Bluetooth	N	N	RF2.4/0812	RF2.4/0812	N
AZ5610	802.11 b/g/n (mini-card)	Bluetooth	N	N	RF2.4/0812	RF2.4/0812	N
AZ5610	802.11 b/g/n (mini-card)	Bluetooth	N	N	RF2.4/0812	RF2.4/0812	N
AZ5610	802.11 b/g/n (mini-card)	Bluetooth	N	N	RF2.4/0812	RF2.4/0812	N
AZ5610	802.11 b/g/n (mini-card)	Bluetooth	N	N	RF2.4/0812	RF2.4/0812	N
AZ5610	802.11 b/g/n (mini-card)	Bluetooth	N	N	RF2.4/0812	RF2.4/0812	N
AZ5610	802.11 b/g/n (mini-card)	Bluetooth	N	N	RF2.4/0812	RF2.4/0812	N
AZ5610	802.11 b/g/n (mini-card)	Bluetooth	N	N	RF2.4/0812	RF2.4/0812	N
AZ5610	802.11 b/g/n (mini-card)	Bluetooth	N	N	RF2.4/0812	RF2.4/0812	N
AZ5610	802.11 b/g/n (mini-card)	Bluetooth	N	N	RF2.4/0812	RF2.4/0812	N
AZ5610	802.11 b/g/n (mini-card)	Bluetooth	N	N	RF2.4/0812	RF2.4/0812	N
AZ5610	802.11 b/g/n (mini-card)	Bluetooth	N	N	RF2.4/0812	RF2.4/0812	N
AZ5610	802.11 b/g/n (mini-card)	Bluetooth	N	N	RF2.4/0812	RF2.4/0812	N
AZ5610	802.11 b/g/n (mini-card)	Bluetooth	N	N	RF2.4/0812	RF2.4/0812	N
AZ5610	802.11 b/g/n (mini-card)	Bluetooth	N	N	RF2.4/0812	RF2.4/0812	N
AZ5610	802.11 b/g/n (mini-card)	Bluetooth	N	N	RF2.4/0812	RF2.4/0812	N
AZ5610	802.11 b/g/n (mini-card)	Bluetooth	N	N	RF2.4/0812	RF2.4/0812	N

Model Name	Add on card 1	Add on card 2	Remote control	RC Receiver	Keyboard	Mouse	Speaker
AZ5610	802.11 b/g/n (mini-card)	Bluetooth	N	N	RF2.4/0812	RF2.4/0812	N
AZ5610	802.11 b/g/n (mini-card)	Bluetooth	N	N	RF2.4/0812	RF2.4/0812	N
AZ5610	802.11 b/g/n (mini-card)	Bluetooth	N	N	RF2.4/0812	RF2.4/0812	N
AZ5610	802.11 b/g/n (mini-card)	Bluetooth	N	N	RF2.4/0812	RF2.4/0812	N
AZ5610	802.11 b/g/n (mini-card)	Bluetooth	N	N	RF2.4/0812	RF2.4/0812	N
AZ5610	802.11 b/g/n (mini-card)	Bluetooth	N	N	RF2.4/0812	RF2.4/0812	N
AZ5610	802.11 b/g/n (mini-card)	Bluetooth	N	N	RF2.4/0812	RF2.4/0812	N
AZ5610	802.11 b/g/n (mini-card)	Bluetooth	N	N	RF2.4/0812	RF2.4/0812	N
AZ5610	802.11 b/g/n (mini-card)	Bluetooth	N	N	RF2.4/0812	RF2.4/0812	N
AZ5610	802.11 b/g/n (mini-card)	Bluetooth	N	N	RF2.4/0812	RF2.4/0812	N
AZ5610	802.11 b/g/n (mini-card)	Bluetooth	N	N	RF2.4/0812	RF2.4/0812	N
AZ5610	802.11 b/g/n (mini-card)	Bluetooth	N	N	RF2.4/0812	RF2.4/0812	N
AZ5610	802.11 b/g/n (mini-card)	Bluetooth	N	N	RF2.4/0812	RF2.4/0812	N
AZ5610	802.11 b/g/n (mini-card)	Bluetooth	N	N	RF2.4/0812	RF2.4/0812	N
AZ5610	802.11 b/g/n (mini-card)	Bluetooth	N	N	RF2.4/0812	RF2.4/0812	N
AZ5610	802.11 b/g/n (mini-card)	Bluetooth	N	N	RF2.4/0812	RF2.4/0812	N
AZ5610	802.11 b/g/n (mini-card)	Bluetooth	N	N	RF2.4/0812	RF2.4/0812	N
AZ5610	802.11 b/g/n (mini-card)	Bluetooth	N	N	RF2.4/0812	RF2.4/0812	N
AZ5610	802.11 b/g/n (mini-card)	Bluetooth	N	N	RF2.4/0812	RF2.4/0812	N
AZ5610	802.11 b/g/n (mini-card)	Bluetooth	N	N	RF2.4/0812	RF2.4/0812	N
AZ5610	802.11 b/g/n (mini-card)	Bluetooth	N	N	RF2.4/0812	RF2.4/0812	N
AZ5610	802.11 b/g/n (mini-card)	Bluetooth	N	N	RF2.4/0812	RF2.4/0812	N
AZ5610	802.11 b/g/n (mini-card)	Bluetooth	N	N	RF2.4/0812	RF2.4/0812	N
AZ5610	802.11 b/g/n (mini-card)	Bluetooth	N	N	RF2.4/0812	RF2.4/0812	N
AZ5610	802.11 b/g/n (mini-card)	Bluetooth	N	N	RF2.4/0812	RF2.4/0812	N

Test Compatible Components

This computer's compatibility is tested and verified by Acer's internal testing department. All of its system functions are tested under Windows® 7 environment.

Refer to the following lists for components, adapter cards, and peripherals which have passed these tests. Regarding configuration, combination and test procedures, please refer to the Aspire Z5600/Z5610 Series Compatibility Test Report released by the Acer Mobile System Testing Department.

Microsoft® Windows® 7 Environment Test

Vendor	Type	Description
Add on card		
QMI	802.11 b/g/n (mini-card)	Lite-On WN6500M, Marvell MC85 802.11 b/g/n (mini-card) Marvell MC85, 802.11 b/g/n WLAN mini-card, 2Tx3R, (PCI-E interface pin assignment)
Lite-On	802.11 b/g/n (mini-card)	Quanta Q802XKN6 WLAN Realtek RTL8187B PCI-Express Q802XKN6, Ralink RT3090 802.11b/g/n 1Tx1R WLAN(mini-card) Full Size
Quanta	Bluetooth	QMI QBT400UB Bluetooth Qcom Technology Inc., Broadcom BCM2046, Bluetooth2.1 + EDR, USB interface module
QMI	802.11 b/g/n (mini-card)	Lite-On WN6500M, Marvell MC85 802.11 b/g/n (mini-card) Marvell MC85, 802.11 b/g/n WLAN mini-card, 2Tx3R, (PCI-E interface pin assignment)
Lite-On	802.11 b/g/n (mini-card)	Quanta Q802XKN6 WLAN Realtek RTL8187B PCI-Express Q802XKN6, Ralink RT3090 802.11b/g/n 1Tx1R WLAN(mini-card) Full Size
Quanta	Bluetooth	QMI QBT400UB Bluetooth Qcom Technology Inc., Broadcom BCM2046, Bluetooth2.1 + EDR, USB interface module
Bezel		
Acer	Santana AIO 23 Black Premium CMF	Acer aSantana Santana AIO 23 Black Premium CMF EL8
	23 inch aSantana Silver LC Bezel	23" aSantana Silver LC Bezel 23" aSantana Silver LC Bezel
Acer	Santana AIO 23 Black Premium CMF	Acer aSantana Santana AIO 23 Black Premium CMF EL8
	23 inch aSantana Silver LC Bezel	23" aSantana Silver LC Bezel 23" aSantana Silver LC Bezel
Card Reader		
	AIO 4-in-1 CR eClapton	AIO 4-in-1 CR eClapton AIO
	AIO 4-in-1 CR eClapton	AIO 4-in-1 CR eClapton AIO
Chassis		
Aspire	Acer Santana 23 inch AIO	Aspire Acer Santana 23 inch AIO Chassis
Aspire	Acer Santana 23 inch AIO	Aspire Acer Santana 23 inch AIO Chassis
CPU/Processor		
INTEL	PDCE2220	CPU Intel Pentium Dual-Core E2220 LGA 2.4G 1M 800 775 65W M-0
INTEL	PDCE5200	CPU Intel Pentium Dual-Core E5200 LGA 2.5G 2M 800 775 65W
INTEL	PDCE5300	CPU Intel Pentium Dual-Core E5300 LGA 2.6G 2M 800 775 65W M-0
INTEL	PDCE5400	CPU Intel Pentium Dual-Core E5400 LGA 2.7G 2M 800 775 65W R-0 Dual Core
INTEL	PDCE6300	CPU Intel Pentium Dual-Core E6300 LGA 2.8G 2M 1066 775 65W R-0
INTEL	PDCE6500	CPU Intel Pentium Dual-Core E6500 LGA 2.93G 2M 1066 775 65W R-0 Dual Core

Vendor	Type	Description
INTEL	C2DE7300	CPU Intel Core2Dual E7300 LGA 2.66G 3M 1066 775 65W M-0
INTEL	C2DE7400	CPU Intel Core2Dual E7400 LGA 2.8G 3M 1066 775 65W R-0 Dual Core,
INTEL	C2DE7500	CPU Intel Core2Dual E7500 LGA 2.93G 3M 1066 775 65W R-0 Dual Core
INTEL	C2DE7600	CPU Intel Core2Dual E7600 LGA 3.06G 3M 1066 775 65W R-0
INTEL	C2QQ8200s	CPU Intel Core2Quad Q8200s LGA 2.33G 4M 1333 775 65W R-0 Quad Core
INTEL	C2DE8400	CPU Intel Core2Dual E8400 LGA 3.0G 6M 1333 775 65W E-0
INTEL	C2QQ8400s	CPU Intel Core2Quad Q8400s LGA 2.66G 4M 1333 775 65W R-0 Quad Core
INTEL	C2DE8500	CPU Intel Core2Dual E8500 LGA 3.16G 6M 1333 775 65W E-0
INTEL	C2DE8600	CPU Intel Core2Dual E8600 LGA 3.33G 6M 1333 775 65W E-0
INTEL	C2QQ9400s	CPU Intel Core2Quad Q9400s LGA 2.66G 6M 1333 775 65W R-0 Quad Core
INTEL	PDCE2220	CPU Intel Pentium Dual-Core E2220 LGA 2.4G 1M 800 775 65W M-0
INTEL	PDCE5200	CPU Intel Pentium Dual-Core E5200 LGA 2.5G 2M 800 775 65W
INTEL	PDCE5300	CPU Intel Pentium Dual-Core E5300 LGA 2.6G 2M 800 775 65W M-0
INTEL	PDCE5400	CPU Intel Pentium Dual-Core E5400 LGA 2.7G 2M 800 775 65W R-0 Dual Core
INTEL	PDCE6300	CPU Intel Pentium Dual-Core E6300 LGA 2.8G 2M 1066 775 65W R-0
INTEL	PDCE6500	CPU Intel Pentium Dual-Core E6500 LGA 2.93G 2M 1066 775 65W R-0 Dual Core
INTEL	C2DE7300	CPU Intel Core2Dual E7300 LGA 2.66G 3M 1066 775 65W M-0
INTEL	C2DE7400	CPU Intel Core2Dual E7400 LGA 2.8G 3M 1066 775 65W R-0 Dual Core,
INTEL	C2DE7500	CPU Intel Core2Dual E7500 LGA 2.93G 3M 1066 775 65W R-0 Dual Core
INTEL	C2DE7600	CPU Intel Core2Dual E7600 LGA 3.06G 3M 1066 775 65W R-0
INTEL	C2QQ8200s	CPU Intel Core2Quad Q8200s LGA 2.33G 4M 1333 775 65W R-0 Quad Core
INTEL	C2DE8400	CPU Intel Core2Dual E8400 LGA 3.0G 6M 1333 775 65W E-0
INTEL	C2QQ8400s	CPU Intel Core2Quad Q8400s LGA 2.66G 4M 1333 775 65W R-0 Quad Core
INTEL	C2DE8500	CPU Intel Core2Dual E8500 LGA 3.16G 6M 1333 775 65W E-0
INTEL	C2DE8600	CPU Intel Core2Dual E8600 LGA 3.33G 6M 1333 775 65W E-0

Vendor	Type	Description
INTEL	C2QQ9400s	CPU Intel Core2Quad Q9400s LGA 2.66G 6M 1333 775 65W R-0 Quad Core
HDD		
SAMSUNG	SSD2564	Flash Disk SAMSUNG SSD NAND 64GB MMCRE64G5MPP-0VA LF
SEAGATE	D1000GB7.2KS	HDD SEAGATE 3.5" 7200rpm 1000GB ST31000528AS(Pharaoh) SATA II 32MB LF F/W:CC44
HGST	D1000GB7.2KS	HDD HGST 3.5" 7200rpm 1000GB HDT721010SLA360 Saturn SATA II 16MB LF F/W:31B
WD	D1000GB5.4KS	HDD WD 3.5" 5400rpm 1000GB WD10EADS-22M2B0 (GP500) SATA II 32MB LF F/W:01.00A01
SEAGATE	D1500GB7.2KS	HDD SEAGATE 3.5" 7200rpm 1500GB ST31500341AS(Brinks) SATA II 32MB LF F/W:CC4H
SEAGATE	D320GB7.2KS	HDD SEAGATE 3.5" 7200rpm 320GB ST3320418AS(Pharaoh) SATA II 16MB LF F/W:CC44
HGST	D320GB7.2KS	HDD HGST 3.5" 7200rpm 320GB HDT721032SLA380 Saturn SATA II LF F/W:31B
WD	D320GB7.2KS	HDD WD 3.5" 7200rpm 320GB WD3200AAJS-22L7A0 XL320S-3 320G SATA II 8MB LF F/W:01.03E01
SEAGATE	D500GB7.2KS	HDD SEAGATE 3.5" 7200rpm 500GB ST3500418AS(Pharaoh) SATA II 16MB LF F/W:CC44
HGST	D640GB7.2KS	HDD HGST 3.5" 7200rpm 640GB HDT721064SLA360 Saturn SATA II 16MB LF F/W:31B
WD	D640GB7.2KS	HDD WD 3.5" 7200rpm 640GB WD6400AAKS-22A7B2 XL320M 640G SATA II 16MB LF F/W:01.03B01
SEAGATE	D750GB7.2KS	HDD SEAGATE 3.5" 7200rpm 750GB ST3750528AS (Pharaoh) SATA II 32MB LF F/W:CC44
WD	D750GB7.2KS	HDD WD 3.5" 7200rpm 750GB WD7502AALS-22E3A0 (XL500) SATA II 32MB LF F/W:05.01D05
SAMSUNG	SSD2564	Flash Disk SAMSUNG SSD NAND 64GB MMCRE64G5MPP-0VA LF
SEAGATE	D1000GB7.2KS	HDD SEAGATE 3.5" 7200rpm 1000GB ST31000528AS(Pharaoh) SATA II 32MB LF F/W:CC44
HGST	D1000GB7.2KS	HDD HGST 3.5" 7200rpm 1000GB HDT721010SLA360 Saturn SATA II 16MB LF F/W:31B
WD	D1000GB5.4KS	HDD WD 3.5" 5400rpm 1000GB WD10EADS-22M2B0 (GP500) SATA II 32MB LF F/W:01.00A01
SEAGATE	D1500GB7.2KS	HDD SEAGATE 3.5" 7200rpm 1500GB ST31500341AS(Brinks) SATA II 32MB LF F/W:CC4H
SEAGATE	D320GB7.2KS	HDD SEAGATE 3.5" 7200rpm 320GB ST3320418AS(Pharaoh) SATA II 16MB LF F/W:CC44
HGST	D320GB7.2KS	HDD HGST 3.5" 7200rpm 320GB HDT721032SLA380 Saturn SATA II LF F/W:31B
WD	D320GB7.2KS	HDD WD 3.5" 7200rpm 320GB WD3200AAJS-22L7A0 XL320S-3 320G SATA II 8MB LF F/W:01.03E01
SEAGATE	D500GB7.2KS	HDD SEAGATE 3.5" 7200rpm 500GB ST3500418AS(Pharaoh) SATA II 16MB LF F/W:CC44
HGST	D640GB7.2KS	HDD HGST 3.5" 7200rpm 640GB HDT721064SLA360 Saturn SATA II 16MB LF F/W:31B

Vendor	Type	Description
WD	D640GB7.2KS	HDD WD 3.5" 7200rpm 640GB WD6400AAKS-22A7B2 XL320M 640G SATA II 16MB LF F/W:01.03B01
SEAGATE	D750GB7.2KS	HDD SEAGATE 3.5" 7200rpm 750GB ST3750528AS (Pharaoh) SATA II 32MB LF F/W:CC44
WD	D750GB7.2KS	HDD WD 3.5" 7200rpm 750GB WD7502AALS-22E3A0 (XL500) SATA II 32MB LF F/W:05.01D05
IR Blaster		
	SMK	SMK IR BLASTER RWS9000-1301FP
	SMK	SMK IR BLASTER RWS9000-1301FP
Keyboard		
CHICONY	RF2.4/0812	Keyboard CHICONY KG-0766 RF2.4 104KS Silver US with new color AC-MT-010
CHICONY	RF2.4/0812	Keyboard CHICONY KG-0766 RF2.4 104KS Silver Traditional Chinese with new color AC-MT-010
CHICONY	RF2.4/0812	Keyboard CHICONY KG-0766 RF2.4 104KS Silver Simplified Chinese with new color AC-MT-010
CHICONY	RF2.4/0812	Keyboard CHICONY KG-0766 RF2.4 104KS Silver US International with new color AC-MT-010
CHICONY	RF2.4/0812	Keyboard CHICONY KG-0766 RF2.4 104KS Silver Arabic/English with new color AC-MT-010
CHICONY	RF2.4/0812	Keyboard CHICONY KG-0766 RF2.4 104KS Silver Thailand with new color AC-MT-010
CHICONY	RF2.4/0812	Keyboard CHICONY KG-0766 RF2.4 105KS Silver Spanish with new color AC-MT-010
CHICONY	RF2.4/0812	Keyboard CHICONY KG-0766 RF2.4 105KS Silver Portuguese with new color AC-MT-010
CHICONY	RF2.4/0812	Keyboard CHICONY KG-0766 RF2.4 105KS Silver Canadian French with new color AC-MT-010
CHICONY	RF2.4/0812	Keyboard CHICONY KG-0766 RF2.4 107KS Silver Brazilian Portuguese with new color AC-MT-010
CHICONY	RF2.4/0812	Keyboard CHICONY KG-0766 RF2.4 109KS Silver Japanese with new color AC-MT-010
CHICONY	RF2.4/0812	Keyboard CHICONY KG-0766 RF2.4 105KS Silver German with new color AC-MT-010
CHICONY	RF2.4/0812	Keyboard CHICONY KG-0766 RF2.4 105KS Silver Italian with new color AC-MT-010
CHICONY	RF2.4/0812	Keyboard CHICONY KG-0766 RF2.4 105KS Silver French with new color AC-MT-010
CHICONY	RF2.4/0812	Keyboard CHICONY KG-0766 RF2.4 105KS Silver Swedish with new color AC-MT-010
CHICONY	RF2.4/0812	Keyboard CHICONY KG-0766 RF2.4 105KS Silver UK with new color AC-MT-010
CHICONY	RF2.4/0812	Keyboard CHICONY KG-0766 RF2.4 105KS Silver Dutch with new color AC-MT-010
CHICONY	RF2.4/0812	Keyboard CHICONY KG-0766 RF2.4 105KS Silver Swiss/G with new color AC-MT-010
CHICONY	RF2.4/0812	Keyboard CHICONY KG-0766 RF2.4 105KS Silver Belgium with new color AC-MT-010

Vendor	Type	Description
CHICONY	RF2.4/0812	Keyboard CHICONY KG-0766 RF2.4 105KS Silver Icelandic with new color AC-MT-010
CHICONY	RF2.4/0812	Keyboard CHICONY KG-0766 RF2.4 105KS Silver Norwegian with new color AC-MT-010
CHICONY	RF2.4/0812	Keyboard CHICONY KG-0766 RF2.4 104KS Silver Hebrew with new color AC-MT-010
CHICONY	RF2.4/0812	Keyboard CHICONY KG-0766 RF2.4 105KS Silver Slovenian with new color AC-MT-010
CHICONY	RF2.4/0812	Keyboard CHICONY KG-0766 RF2.4 105KS Silver Slovak with new color AC-MT-010
CHICONY	RF2.4/0812	Keyboard CHICONY KG-0766 RF2.4 104KS Silver Russian with new color AC-MT-010
CHICONY	RF2.4/0812	Keyboard CHICONY KG-0766 RF2.4 105KS Silver Hungarian with new color AC-MT-010
CHICONY	RF2.4/0812	Keyboard CHICONY KG-0766 RF2.4 104KS Silver Greek with new color AC-MT-010
CHICONY	RF2.4/0812	Keyboard CHICONY KG-0766 RF2.4 105KS Silver Danish with new color AC-MT-010
CHICONY	RF2.4/0812	Keyboard CHICONY KG-0766 RF2.4 104KS Silver Czech with new color AC-MT-010
CHICONY	RF2.4/0812	Keyboard CHICONY KG-0766 RF2.4 105KS Silver Romanian with new color AC-MT-010
CHICONY	RF2.4/0812	Keyboard CHICONY KG-0766 RF2.4 105KS Silver Turkish with new color AC-MT-010
CHICONY	RF2.4/0812	Keyboard CHICONY KG-0766 RF2.4 105KS Silver Turkish-Q with new color AC-MT-010
CHICONY	RF2.4/0812	Keyboard CHICONY KG-0766 RF2.4 105KS Silver Arabic/French with new color AC-MT-010
CHICONY	RF2.4/0812	Keyboard CHICONY KG-0766 RF2.4 104KS Silver Kazakh with new color AC-MT-010
CHICONY	RF2.4/0812	Keyboard CHICONY KG-0766 RF2.4 104KS Silver Turkmen with new color AC-MT-010
CHICONY	RF2.4/0812	Keyboard CHICONY KG-0766 RF2.4 105KS Silver Nordic with new color AC-MT-010
CHICONY	RF2.4/0812	Keyboard CHICONY KG-0766 RF2.4 105KS Silver Spanish Latin with new color AC-MT-010
CHICONY	RF2.4/0812	Keyboard CHICONY KG-0766 RF2.4 105KS Silver Polish with new color AC-MT-010
CHICONY	RF2.4/0812	Keyboard CHICONY KG-0766 RF2.4 104KS Silver US with new color AC-MT-010
CHICONY	RF2.4/0812	Keyboard CHICONY KG-0766 RF2.4 104KS Silver Traditional Chinese with new color AC-MT-010
CHICONY	RF2.4/0812	Keyboard CHICONY KG-0766 RF2.4 104KS Silver Simplified Chinese with new color AC-MT-010
CHICONY	RF2.4/0812	Keyboard CHICONY KG-0766 RF2.4 104KS Silver US International with new color AC-MT-010
CHICONY	RF2.4/0812	Keyboard CHICONY KG-0766 RF2.4 104KS Silver Arabic/English with new color AC-MT-010
CHICONY	RF2.4/0812	Keyboard CHICONY KG-0766 RF2.4 104KS Silver Thailand with new color AC-MT-010

Vendor	Type	Description
CHICONY	RF2.4/0812	Keyboard CHICONY KG-0766 RF2.4 105KS Silver Spanish with new color AC-MT-010
CHICONY	RF2.4/0812	Keyboard CHICONY KG-0766 RF2.4 105KS Silver Portuguese with new color AC-MT-010
CHICONY	RF2.4/0812	Keyboard CHICONY KG-0766 RF2.4 105KS Silver Canadian French with new color AC-MT-010
CHICONY	RF2.4/0812	Keyboard CHICONY KG-0766 RF2.4 107KS Silver Brazilian Portuguese with new color AC-MT-010
CHICONY	RF2.4/0812	Keyboard CHICONY KG-0766 RF2.4 109KS Silver Japanese with new color AC-MT-010
CHICONY	RF2.4/0812	Keyboard CHICONY KG-0766 RF2.4 105KS Silver German with new color AC-MT-010
CHICONY	RF2.4/0812	Keyboard CHICONY KG-0766 RF2.4 105KS Silver Italian with new color AC-MT-010
CHICONY	RF2.4/0812	Keyboard CHICONY KG-0766 RF2.4 105KS Silver French with new color AC-MT-010
CHICONY	RF2.4/0812	Keyboard CHICONY KG-0766 RF2.4 105KS Silver Swedish with new color AC-MT-010
CHICONY	RF2.4/0812	Keyboard CHICONY KG-0766 RF2.4 105KS Silver UK with new color AC-MT-010
CHICONY	RF2.4/0812	Keyboard CHICONY KG-0766 RF2.4 105KS Silver Dutch with new color AC-MT-010
CHICONY	RF2.4/0812	Keyboard CHICONY KG-0766 RF2.4 105KS Silver Swiss/G with new color AC-MT-010
CHICONY	RF2.4/0812	Keyboard CHICONY KG-0766 RF2.4 105KS Silver Belgium with new color AC-MT-010
CHICONY	RF2.4/0812	Keyboard CHICONY KG-0766 RF2.4 105KS Silver Icelandic with new color AC-MT-010
CHICONY	RF2.4/0812	Keyboard CHICONY KG-0766 RF2.4 105KS Silver Norwegian with new color AC-MT-010
CHICONY	RF2.4/0812	Keyboard CHICONY KG-0766 RF2.4 104KS Silver Hebrew with new color AC-MT-010
CHICONY	RF2.4/0812	Keyboard CHICONY KG-0766 RF2.4 105KS Silver Slovenian with new color AC-MT-010
CHICONY	RF2.4/0812	Keyboard CHICONY KG-0766 RF2.4 105KS Silver Slovak with new color AC-MT-010
CHICONY	RF2.4/0812	Keyboard CHICONY KG-0766 RF2.4 104KS Silver Russian with new color AC-MT-010
CHICONY	RF2.4/0812	Keyboard CHICONY KG-0766 RF2.4 105KS Silver Hungarian with new color AC-MT-010
CHICONY	RF2.4/0812	Keyboard CHICONY KG-0766 RF2.4 104KS Silver Greek with new color AC-MT-010
CHICONY	RF2.4/0812	Keyboard CHICONY KG-0766 RF2.4 105KS Silver Danish with new color AC-MT-010
CHICONY	RF2.4/0812	Keyboard CHICONY KG-0766 RF2.4 104KS Silver Czech with new color AC-MT-010
CHICONY	RF2.4/0812	Keyboard CHICONY KG-0766 RF2.4 105KS Silver Romanian with new color AC-MT-010
CHICONY	RF2.4/0812	Keyboard CHICONY KG-0766 RF2.4 105KS Silver Turkish with new color AC-MT-010

Vendor	Type	Description
CHICONY	RF2.4/0812	Keyboard CHICONY KG-0766 RF2.4 105KS Silver Turkish-Q with new color AC-MT-010
CHICONY	RF2.4/0812	Keyboard CHICONY KG-0766 RF2.4 105KS Silver Arabic/French with new color AC-MT-010
CHICONY	RF2.4/0812	Keyboard CHICONY KG-0766 RF2.4 104KS Silver Kazakh with new color AC-MT-010
CHICONY	RF2.4/0812	Keyboard CHICONY KG-0766 RF2.4 104KS Silver Turkmen with new color AC-MT-010
CHICONY	RF2.4/0812	Keyboard CHICONY KG-0766 RF2.4 105KS Silver Nordic with new color AC-MT-010
CHICONY	RF2.4/0812	Keyboard CHICONY KG-0766 RF2.4 105KS Silver Spanish Latin with new color AC-MT-010
CHICONY	RF2.4/0812	Keyboard CHICONY KG-0766 RF2.4 105KS Silver Polish with new color AC-MT-010
LCD		
SAMSUNG	D23FHD	CCFL LCD SAMSUNG 23"W FHD None Glare LTM230HT01 A03 LF 300nit 5ms 1000:1
SAMSUNG	D23FHD	CCFL LCD SAMSUNG 23"W FHD None Glare LTM230HT01 A04 LF 300nit 5ms 1000:1
LPL	D23FHD	CCFL LCD LPL 23"W FHD None Glare LM230WF1 TLA3 LF 300nit 5ms
SAMSUNG	D23FHD	CCFL LCD SAMSUNG 23"W FHD None Glare LTM230HT01 A03 LF 300nit 5ms 1000:1
SAMSUNG	D23FHD	CCFL LCD SAMSUNG 23"W FHD None Glare LTM230HT01 A04 LF 300nit 5ms 1000:1
LPL	D23FHD	CCFL LCD LPL 23"W FHD None Glare LM230WF1 TLA3 LF 300nit 5ms
Mainboard		
	aSantana QIG45M_1394(N)_Logo(N)	Mainboard G45 Intel G45 ICH10 Realtek 8111 Acer Logo Proprietary W/O 1394 LF
	aSantana QIG45M_1394(N)_Logo(N)	MB Kit G45 Intel G45 ICH10 Realtek 8111 Acer Logo Proprietary W/O 1394 LF
	Santana_Discrete QIG45M_1394(N)_Logo(N)	Mainboard Mainboard Intel G45 Discrete ICH10 Intel GM45 ICH10 W/O 1394 LF
	Santana_Discrete QIG45M_1394(N)_Logo(N)	MB Kit Mainboard Intel G45 Discrete ICH10 Intel GM45 ICH10 W/O 1394 LF
Memory		
NANYA	U1GBIII13	Memory NANYA UNB-DIMM DDRIII 1333 1GB NT1GC64B88A0NF-CG LF 128*8 0.07um
SAMSUNG	U1GBIII13	Memory SAMSUNG UNB-DIMM DDRIII 1333 1GB M378B2873EH1-CH9 LF 128*8 0.055um
HYNIX	U1GBIII13	Memory HYNIX UNB-DIMM DDRIII 1333 1GB HMT112U6BFR8C-H9 LF 128*8 0.055um
UNIFOSA	U1GBIII13	Memory UNIFOSA UNB-DIMM DDRIII 1333 1GB GU502203EP0201 LF 128*8 0.065um
NANYA	U2GBIII13	Memory NANYA UNB-DIMM DDRIII 1333 2GB NT2GC64B88A0NF-CG LF 128*8 0.07um
SAMSUNG	U2GBIII13	Memory SAMSUNG UNB-DIMM DDRIII 1333 2GB M378B5673EH1-CH9 LF 128*8 0.055um

Vendor	Type	Description
HYNIX	U2GBIII13	Memory HYNIX UNB-DIMM DDRIII 1333 2GB HMT125U6BFR8C-H9 LF 128*8 0.055um
UNIFOSA	U2GBIII13	Memory UNIFOSA UNB-DIMM DDRIII 1333 2GB GU512303EP0202 LF 128*8 0.065um
NANYA	U1GBIII13	Memory NANYA UNB-DIMM DDRIII 1333 1GB NT1GC64B88A0NF-CG LF 128*8 0.07um
SAMSUNG	U1GBIII13	Memory SAMSUNG UNB-DIMM DDRIII 1333 1GB M378B2873EH1-CH9 LF 128*8 0.055um
HYNIX	U1GBIII13	Memory HYNIX UNB-DIMM DDRIII 1333 1GB HMT112U6BFR8C-H9 LF 128*8 0.055um
UNIFOSA	U1GBIII13	Memory UNIFOSA UNB-DIMM DDRIII 1333 1GB GU502203EP0201 LF 128*8 0.065um
NANYA	U2GBIII13	Memory NANYA UNB-DIMM DDRIII 1333 2GB NT2GC64B88A0NF-CG LF 128*8 0.07um
SAMSUNG	U2GBIII13	Memory SAMSUNG UNB-DIMM DDRIII 1333 2GB M378B5673EH1-CH9 LF 128*8 0.055um
HYNIX	U2GBIII13	Memory HYNIX UNB-DIMM DDRIII 1333 2GB HMT125U6BFR8C-H9 LF 128*8 0.055um
UNIFOSA	U2GBIII13	Memory UNIFOSA UNB-DIMM DDRIII 1333 2GB GU512303EP0202 LF 128*8 0.065um
Mouse		
Chicony	RF2.4/0812	Chicony wireless mouse RF2.4 MG-0766 with new colorAC-MT-010
Chicony	RF2.4/0812	Chicony wireless mouse RF2.4 MG-0766 with new colorAC-MT-010
ODD		
PLDS	NBDCB4XSSLOT	ODD PLDS BD COMBO 12.7mm Slot 4X DL-4ETS W/ O bezel SATA (Win7 F/W)
SONY	NSM8XSLFSLOT	ODD SONY Super-Multi DRIVE 12.7mm Slot LabelFlash 8X AD-7643S LF W/O bezel SATA w/ Win7
PLDS	NBDCB4XSSLOT	ODD PLDS BD COMBO 12.7mm Slot 4X DL-4ETS W/ O bezel SATA (Win7 F/W)
SONY	NSM8XSLFSLOT	ODD SONY Super-Multi DRIVE 12.7mm Slot LabelFlash 8X AD-7643S LF W/O bezel SATA w/ Win7
Optional Accessories		
Chicony	WebCam	Chicony Web Cam USB Panda 11-E
PSU		
	FR 250W (AIO) EuP 82+_Acer	PSU DELTA DPS-250AB-53A 250W Active PFC Custom "Open" Frame 100-127V/220-240V, EPA 5.0, All-in-One for Acer
	FR 250W (AIO) EuP 82+_Acer	PSU DELTA DPS-250AB-53A 250W Active PFC Custom "Open" Frame 100-127V/220-240V, EPA 5.0, All-in-One for Acer
Remote Control		
Philips	EMEA Vista MCE	Philips Vista MCE iconized RC with 2 batteries for EMEA
Philips	US Vista MCE	Philips Vista MCE iconized RC with 2 batteries for US
Philips	EMEA Vista RC	Philips Vista remote control for OVU71

Vendor	Type	Description
Philips	EMEA Win7/Philips	Philips Remote Controller RC2604307/01BG for EMEA ;pair with RV.11000.007
Philips	US Win7 WMC	Philips Remote Controller RC2604302/01B MSFT code US;pair with OVU430005
Philips	EMEA Win7 WMC	Philips Remote Controller RC2604301/01B MSFT code EMEA;pair with OVU430005
Philips	EMEA Vista MCE	Philips Vista MCE iconized RC with 2 batteries for EMEA
Philips	US Vista MCE	Philips Vista MCE iconized RC with 2 batteries for US
Philips	EMEA Vista RC	Philips Vista remote control for OVU71
Philips	EMEA Win7/Philips	Philips Remote Controller RC2604307/01BG for EMEA ;pair with RV.11000.007
Philips	US Win7 WMC	Philips Remote Controller RC2604302/01B MSFT code US;pair with OVU430005
Philips	EMEA Win7 WMC	Philips Remote Controller RC2604301/01B MSFT code EMEA;pair with OVU430005
TV Tuner		
AverMedia	mCard/Digital/DMB-TH	AverMedia A328 Mini-Card DMB-TH Digital
AverMedia	mCard/SW/DVB-T	AverMedia A336-D Mini-Card Kits WW Analog + DVB-T Digital w/i Quanta internal/external cable
AverMedia	mCard/SW/ATSC	AverMedia A336-A Mini-Card Kits WW Analog + ATSC Digital w/i Quanta internal/external cable
AverMedia	mCard/Digital/DMB-TH	AverMedia A328 Mini-Card DMB-TH Digital
AverMedia	mCard/SW/DVB-T	AverMedia A336-D Mini-Card Kits WW Analog + DVB-T Digital w/i Quanta internal/external cable
AverMedia	mCard/SW/ATSC	AverMedia A336-A Mini-Card Kits WW Analog + ATSC Digital w/i Quanta internal/external cable
VGA Card		
MSI	ATI HD4570 D2 512MB-Santana Type A	MSI VGA Card AMD M92XT DDRII 512M 500MHz 64*16 MXM 3.0 Type A w/ Hynix H5PS1G63EFR-20L for Quanta Santana

Online Support Information

This section describes online technical support services available to help you repair your Acer Systems.

If you are a distributor, dealer, ASP or TPM, please refer your technical queries to your local Acer branch office. Acer Branch Offices and Regional Business Units may access our website. However some information sources will require a user i.d. and password. These can be obtained directly from Acer CSD Taiwan.

Acer's Website offers you convenient and valuable support resources whenever you need them.

In the Technical Information section you can download information on all of Acer's Notebook, Desktop and Server models including:

- Service guides for all models
- User's manuals
- Training materials
- Bios updates
- Software utilities
- Spare parts lists
- TABs (Technical Announcement Bulletin)

For these purposes, we have included an Acrobat File to facilitate the problem-free downloading of our technical material.

Also contained on this website are:

- Detailed information on Acer's International Traveler's Warranty (ITW)
- Returned material authorization procedures
- An overview of all the support services we offer, accompanied by a list of telephone, fax and email contacts for all your technical queries.

We are always looking for ways to optimize and improve our services, so if you have any suggestions or comments, please do not hesitate to communicate these to us.

A

- Audio Board
 - Removing 47
 - Replacing 78

B

- Base Assembly
 - Removing 38
 - Replacing 86
- BIOS
 - password control 12
 - ROM size 11
 - ROM type 11
 - vendor 11
 - Version 11
- BIOS Supports protocol 12
- BIOS Utility 17–32
 - Advanced 23
 - Boot 31
 - Exit 32
 - Information 18
 - Main 19
 - Navigating 17
 - PC Health 29
 - Power 30
 - Save and Exit 32
 - Security 26
 - System Security 32
- Board Layout
 - Bottom View 118
 - Top View 117

C

- Camera Board
 - Removing 49
 - Replacing 76
- Cover Grille
 - Replacing 88
- CPU
 - Removing 50
 - Replacing 75
- CPU Fan
 - Removing 45
 - Replacing 80

D

- Disassembly
 - General Information 33
- Disassembly Requirements 33

F

- Features 1
- FRU (Field Replaceable Unit) List 123

H

- HDD Module
 - Removing 55, 57

I

- Intermittent Problems 116
- Inverter Board
 - Removing 48
 - Replacing 77

J

- Jumper and Connector Locations 117
 - Top View 117

K

- Keyboard
 - Usage 8

L

- LCD Bezel
 - Removing 41
 - Replacing 84
- LCD Brackets
 - Removing 44
 - Replacing 81
- LCD Cable
 - Removing 44
 - Replacing 81
- LCD Module
 - Removing 39
 - Replacing 85
- LCD Panel
 - Removing 42

M

Main Unit Disassembly

Flowchart 34

Mainboard

Removing 53

Replacing 73

Memory Module

Removing 51

Model Definition 136

O

ODD Bezel

Replacing 87

Online Support Information 197

P

Panel 4

front 4

Pin1 Location 75

S

Support Bracket

Removing 56

Replacing 69

System

Block Diagram 3

T

Test Compatible Components 187

Thermal Module

Replacing 79

U

Undetermined Problems 116

utility

BIOS 17–32

W

Windows 2000 Environment Test 188

WLAN Board

Removing 52